

Pantera



Pantera 4503 self-propelled sprayer

Designed for performance



That teamwork of style and performance of the Pantera, which in the “transportation design/special vehicles” category, convinced and impressed the iF jury which comprised of experts and designers from all over the world. The evaluation criteria for the jury included, in addition to design, quality of workmanship and the choice of materials, the degree of innovation and environmental impact, as well as the functionality, ergonomics, visualisation of its intended use and safety.



- From choice, all new AMAZONE sprayers can be provided with an official sprayer proficiency certificate. The proficiency certificate meets current EU regulations according to EN ISO 16122, which is, for European member states, supported also with the CEMA label.

The Pantera 4503 self-propelled sprayer has a tank capacity of 4,500 l and is available in boom widths from 21 m to 40 m. With stepless track width adjustment as standard, it makes the Pantera the universal all-rounder, particularly when used amongst neighbouring farms. By using the different chassis types, it allows the Pantera, Pantera-W and Pantera-H to fulfil a wide variety different applications.



Pantera 4503

More intelligence - more accuracy

	Page
The advantages at a glance	4
Intelligent chassis management	6
Intelligent drive management	12
Intelligent steering management	16
Intelligent cab management	18
Intelligent operational management	20
Intelligent liquid management	22
Boom	26
Part-width section control Individual nozzle control	38
End nozzle control Liquid fertilisation	42
Nozzles	44
ISOBUS	46
Standard equipment	56
AmaProTect	58
AMAZONE Service	60
Technical data	62

! “... completely automotive driving mode, even when spraying”
(profi 11/2011)

Pantera 4503

The universal all-rounder

Hydrostatic drive from

0 to 50 km/h

Boom widths of

21 to 40 m



The advantages at a glance:

- ⊕ Unique tandem chassis – for a smooth and horizontal boom ride and better stability on slopes
- ⊕ Intelligent chassis management with front wheel, all-wheel and dog leg steering for even greater manoeuvrability
- ⊕ Infinitely-variable hydrostatic single range drive – for speeds from 0 to 50 km/h
- ⊕ Performance when it is needed. ECO mode and POWER mode
- ⊕ Pantera⁺ for exceptional climbing ability
- ⊕ DUS or DUS pro pressure recirculation systems ensure continuous circulation of the spray agent
- ⊕ Working speeds of up to 30 km/h ensure high outputs
- ⊕ Fully automatic DistanceControl boom guidance
- ⊕ **For difficult terrain conditions:**
 - CountourControl active boom guidance for the optimum vertical boom guidance
 - SwingStop active boom tip swing compensation to reduce horizontal boom movements
- ⊕ 50 cm part-width sections and optimum nozzle choice thanks to the electric AmaSwitch and AmaSelect individual nozzle control

6-cylinder diesel engine with

160 kW/218 HP

maximum power rating

Spray liquid tank with

4,500 litres



MORE INFORMATION
www.amazone.net/pantera

Pantera 4503

Track width adjustment in no time at all



Pantera 4503

The standard, automatic track width adjustment allows a quick response to different applications and crops. Once the desired track width has been pre-selected, the exact centimetre precise setting is carried out automatically.



✔ Standard with wheel motor covers

Pantera 4503

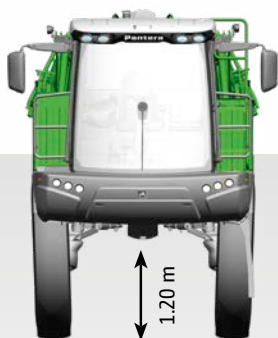

Track width adjustment:
1.80–2.40 m at a clearance of 1.20 m

Pantera 4503-W

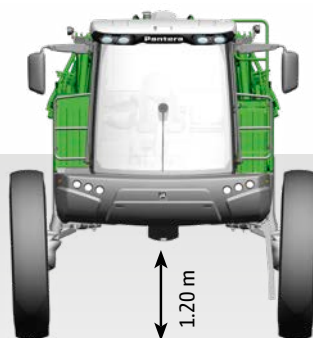

Track width adjustment:
2.25–3.00 m at a clearance of 1.20 m

Pantera 4503-H

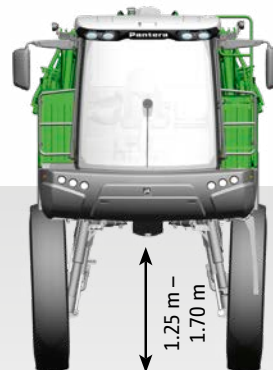

Track width adjustment:
1.80–2.40 m at a clearance of 1.25 m
2.10–2.60 m at a clearance of 1.70 m

Pantera 4503-W

Track width adjustment up to 3 m

The Pantera 4503-W is equipped with track width adjustment from 2.25 m to 3.00 m. In “Controlled Traffic Farming” systems, the track width adjustment of the Pantera-W provides the ideal alternative. This equipment level is also

of benefit for when operating in potato crops without tramlines as four rows of potatoes fit underneath the machine resulting in high stability and it also ensures minimal plant damage.



Pantera 4503-H

Ground clearance up to 1.70 m



Increased flexibility

At the touch of a button on the operator terminal, the driver can lift the machine up to a ground clearance of 1.70 m. With the machine in the lifted position, the track width can be adjusted between 2.10 and 2.60 m. The broad track width spectrum makes it possible to vary the track width between 1.80 m and 2.40 m when in normal applications which only require a 1.25 m ground clearance.

In spite of its higher centre of gravity, the Pantera 4503-H turns out to be very stable and can be flexibly used in a wide variety of crops and row spacings. In particular, contractors looking to offer a flexible plant protection service across a wide range of customers and crops can clearly increase the scope of crop protection treatments possible.



Pantera-H chassis

- ✔ This variable track width adjustment allows it to travel in a standing maize or sunflower crop. In this way, even with different row spacings, the wheels do not run over any plants. (traction magazine "Working Test Pantera 4502-H" · 2/2015)



Wheel motor covers



Drive wheel gearboxes covers

Crop divider

More protection for machine and plants

For an even further improved protection, AMAZONE offers, in addition to the standard wheel motor guards, with the drive wheel gearbox covers, the crop dividers and the underbody protection plate, three further special options for the Pantera-H.



SunflowerKit

Crop-saving SunflowerKit

The SunflowerKit, specifically for the Pantera-H, has been developed so as to be able to carry out plant protection and fertiliser applications in tall crops without causing too much plant damage. The kit consists of crop dividers, wheel housings and a shaped, flexible underbelly sheet. The crop dividers precisely separate the plants between the

rows directly in front of the tyres and, thanks to the special shaped profile of the cover and the properties of the flexible material, the plants are guided between the wheels in a funnel shape to the machine centre and pass unhindered underneath the machine.



Chassis management

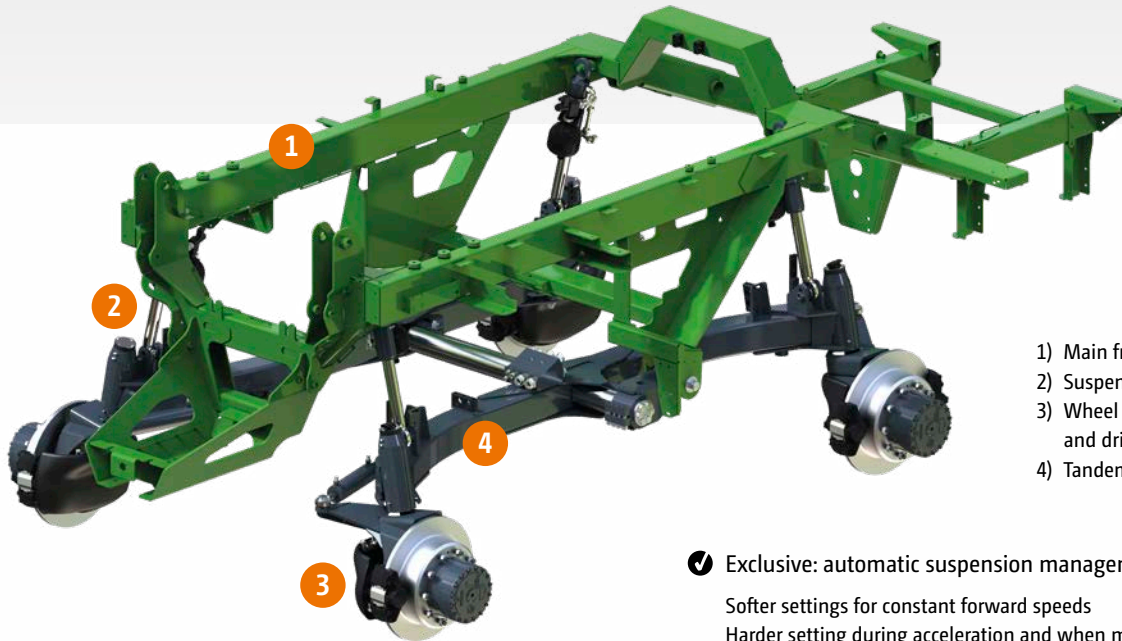

- 1) Main frame
- 2) Suspension
- 3) Wheel motor with disc brakes and drive gearboxes
- 4) Tandem chassis

- ✔ Exclusive: automatic suspension management
Softer settings for constant forward speeds
Harder setting during acceleration and when manoeuvring

The outstanding longitudinal tandem chassis

AMAZONE Pantera

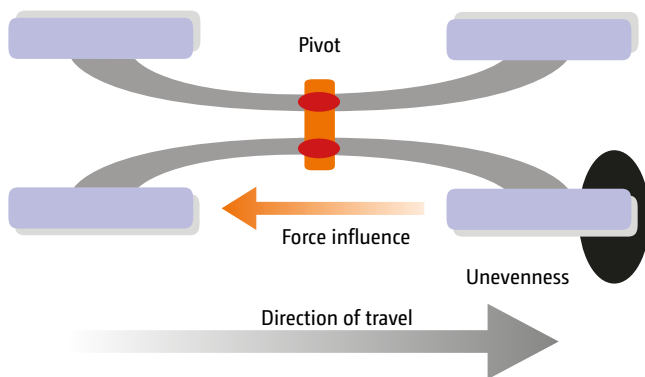

Conventional chassis

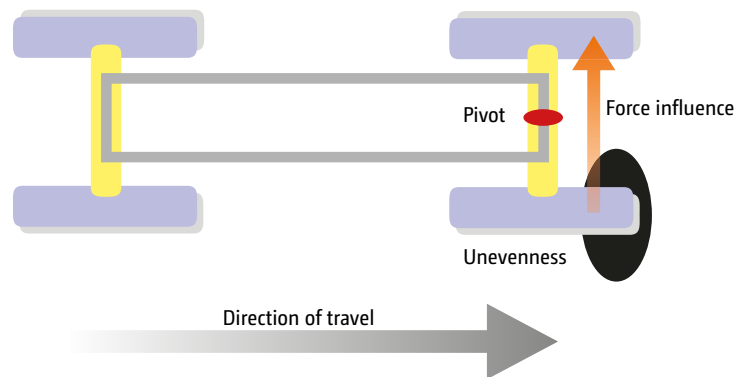

- ✔ The unevenness under the right hand front wheel is compensated by the elongated tandem.
The pivot point is only slightly lifted. Only a slight transmission of the forces onto the frame.

The advantages of the Pantera chassis:

- ✔ Pendulum frame for optimised soil contact and reduced slip
- ✔ Comfortable and safe driving behaviour from the longitudinal tandem
- ✔ Hydro-pneumatic suspension system with level regulation
- ✔ Super-robust frame
- ✔ Reliable hydraulic system – no air regulation
- ✔ Infinitely variable track width adjustment
- ✔ Large ground clearance
- ✔ Headland management for both steering and boom functions means stress relief for the driver and gentle boom treatment

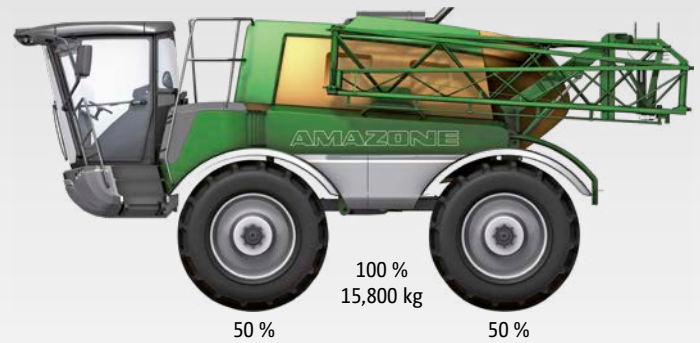

Weight distribution when full and with the booms folded out

Pantera 4503, 24 m, 520/85R38, unladen weight 9,850 kg

Pantera – with light-footed intelligence

The special tandem chassis of the Pantera not only ensures the perfect adaptation to ground undulations, but also a high boom stability – especially of course, in sloping terrain. Thanks to the level regulated hydro-pneumatic suspension, the Pantera operator also enjoys the maximum level of comfort.

The combination of this unique chassis design and the proven AMAZONE boom suspension additionally ensures an optimally smooth boom ride even under the most arduous of conditions.

Trailer tow hitch

The optionally offered trailer hitch can tow a twin-axle water bowser with a laden weight up to 16 t behind the Pantera.



Weight distribution at the optimum!

Even weight distribution between the front and rear wheels is one of the basic requirements for efficient power transfer to the ground.

The Pantera 4503 was therefore designed to have an optimal weight distribution of approximately 50% on both the front and the rear axles when the tank is full. Depending on the tank level and the boom type, the weight distribution varies only by around 5%.

Nearly unbounded – exceptional ground clearance

The big ground clearance of 1.20 m also proves to be an important advantage for the Pantera in practice. With Pantera-H, a ground clearance of even 1.70 m. This is an advantage that is of benefit for you especially when spraying rape at flowering, or even also in taller maize crops – a more gentle plant treatment can hardly be possible.



Drive-line management with optimised fuel efficiency

Pantera – high-powered intelligence

New Stage 5 emissions compliant engine

The new Stage 5 emission compliant engine from AMAZONE uses exhaust gas recirculation, a diesel oxidation catalyst and a diesel particle filter to help protect the environment. The diesel particulate filter is continuously regenerating during operation. The SCR catalytic converter reduces, with the aid of a diesel exhaust fluid (DEF) injection, the levels of nitrogen oxide. The new 20 litre DEF tank is positioned at the side of the 230 litre diesel tank. The DEF consumption amounts to approximately 2.5% of the fuel consumption, meaning that the DEF tank only requires refilling every 3 or 4 diesel tank fills.

Ihre Vorteile:

- ✔ Stepless hydrostatic drive from 0 to 50 km/h*
- ✔ State-of-the-art fuel management on the road and in the field with ECO and POWER mode
- ✔ Tailor-made speed regulated radiator fan drive
- ✔ Proven Deutz technology with a comprehensive service network

The heart as a unit: engine and hydrostatic drive

Deutz 6-cylinder diesel engine with a maximum output of 160 kW (218 HP)

- ✔ Turbocharger with intercooler
- ✔ Common-Rail injection technology
- ✔ 6.06 litres capacity
- ✔ Country-specific execution according to either Stage 3A or Stage 5 emission compliance

- ❗ “The Amazone Pantera impresses by its low diesel consumption, the minimal noise level, the good weight distribution and sufficient payload.”
(profi 12/2011)

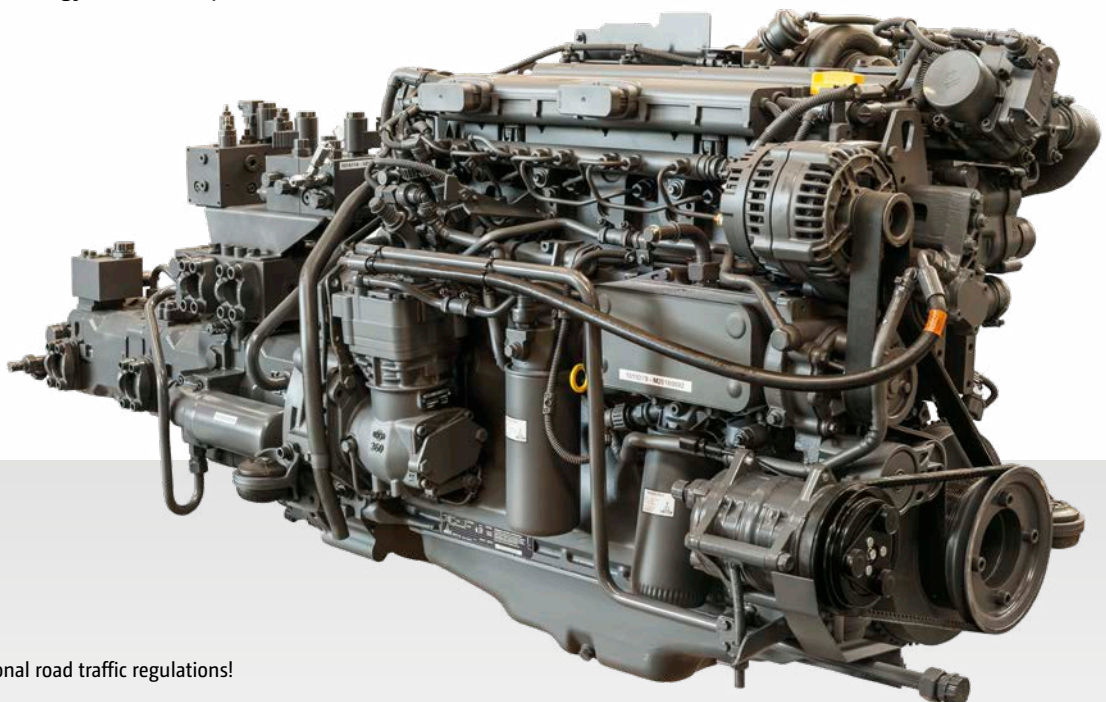

* Please be aware of national road traffic regulations!

The benefits of a clever cooling system:

- ✔ revs on demand
- ✔ at low power requirement and cool temperatures the fans are even switched off
- ✔ Layout beyond the reach of dirt
 - left hand: charge air, hydraulics
 - right hand: engine, air-conditioning

**Operation at optimum fuel saving: ECO or POWER**

The new and optimised engine revs regulation enables you to operate the Pantera always at the optimum fuel consumption efficiency. When ECO Mode has been selected in the AmaDrive vehicle terminal, the engine will search for the optimal operating point for torque and revs in the given driving situation.

When spraying on the flat, an engine rev reduction down to 950 RPM is possible. The automatic speed adaptation takes place constantly and sensibly between 950 and 2,000 RPM. However, when working on steep slopes, or operating with a full tank in hilly terrain, maximum power at up to 2,000 rpm can be drawn upon by using the POWER Mode.

Example in ECO mode

- 1) **On the flat, around 80 KW is required**
- 2) **When the machine is climbing a hill, the torque increases under load.** The speed remains constant.
- 3) **The climb takes longer: the power consumption increases to 120 kW.** The speed remains constant with slightly increased fuel consumption.

Infinitely variable power

The powerful Deutz 6-cylinder diesel engine with Common-Rail injection technology provides 218 HP and impresses by its high performance yet low fuel consumption. Thanks to the modern hydrostatic drive mechanism, you can drive the Pantera with absolute infinite variability.

This system allows, even at a low engine speeds, high start-up torques and a very dynamic acceleration.

Good power/weight ratio

The low unladen weight of the Pantera 4503 (9,900 kg in a 24 metre working width) is another advantage with regard to the lower fuel consumption. So, the fuel tank volume of 230 litres enables high work rates over long days.



- ✔ New, integrated DEF tank for the Pantera with its Stage 5 emission compliance engine

Brake management:

Your safety is paramount!



- ! "The Amazone Pantera shows very good driving behaviour with a speed of 42 km/h at just 1400 revs." (profi 12/2011)

Pantera – safe intelligence

When the speed is reduced the hydrostatic dual circuit braking of the Pantera is activated and elegantly brakes the vehicle down to a complete stop. Especially noticeable here is that with the hydrostatic deceleration of the vehicle the built-in trailer braking system is also energised early.

Traction control as standard

The drive torque of the four wheel motors is constantly being monitored electronically and then regulated to ensure the optimum vehicle behaviour even under difficult conditions. Power-consuming differential locks are avoided. ABS also ensures safe driving on the road at all times.

Advantages of the braking system:

- ✔ Safe and elegant driving performance
- ✔ Reliable braking performance, even during emergency stops from 50 km/h or with a full bowser behind
- ✔ Automatic activation of the parking brake when standing still
- ✔ Autohold assist when starting off on a slope

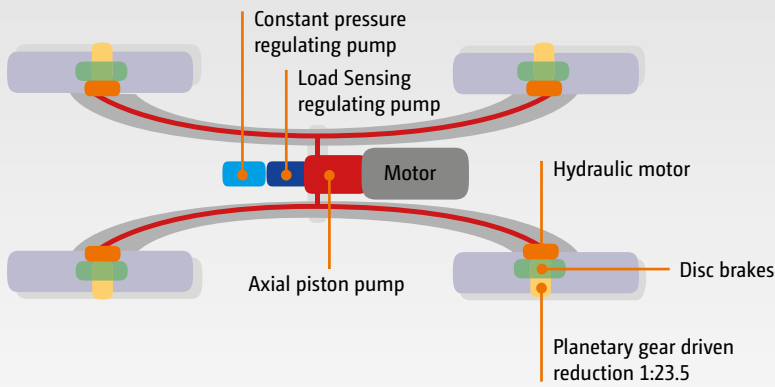

Pantera – flexible intelligence

Due to the large wheel diameter, particularly high torques are necessary when starting off. The intelligent drive concept of the Pantera doesn't build up these high forces hydraulically but translates these into mechanical forces via the planetary gearboxes. This means a particularly reliable drive under difficult ground conditions and when starting off. The electrically controlled wheel motors are always optimally adjusted according to the driving situation, irrespective of whether maximum torque or maximum revs is required.

Pantera⁺ drive concept – powerful intelligence

With the Pantera⁺, AMAZONE offers a drive concept that is particularly suitable for that extreme terrain found in hilly areas. The standard drive wheel gearboxes, across all of the Pantera range, are replaced by an alternative gearbox with a drive ratio of 1:30 (instead of 1:23.5). Due to these alternative gearboxes, the Pantera⁺ has a smaller drive ratio and so therefore, if required, considerably more torque.

Quick-running hydrostatic transmission with reduction gear at the wheel



- ✔ High torque at all times
- ✔ No speed change steps
- ✔ Possibility of larger wheel diameters
- ✔ The adjustable axial piston pump provides an oil flow to the hydraulic motor
- ✔ Every hydraulic motor is individually speed regulated (traction control)
- ✔ A fixed reduction ratio in the planetary gearboxes drive the wheels

Steering management:

It has to be manoeuvrable, compact and flexible!



Front-wheel steering



All-wheel steering



Dog leg steer

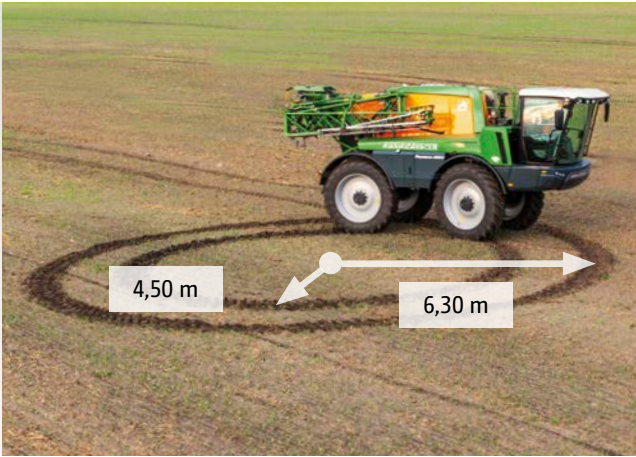

Relax and enjoy your work – even on the headland

In spite of the size of the vehicle, the minimum turning circle of the Pantera is only 4.50 m when in all-wheel steer. This extreme manoeuvrability massively increases work rates, particularly in small fields. Switching between all-wheel and front-wheel steering as well as the steering correction is carried out by using the multi-function joystick. Dog leg steer helps you keep perfectly on track, even on a side slope. Driving in an offset track in dog leg steering mode provides positive advantages when in wet conditions on pressure-sensitive soils.

The Pantera also shows its intelligence on the headland: If headland management has been activated on the Ama-Drive vehicle terminal, switching off the sprayer automatically switches to all-wheel steering and the boom is lifted. When switching on after a turn, the front-wheel steering again ensures the perfect positioning of the boom.

✓ Central lubrication system

The fully-automated central lubrication system ensures the continual readiness of the Pantera for operation.

Automated steering systems

AMAZONE offers a GPS-based automated steering solution in the form of the Steer-Ready pack that controls the orbital steering valve. When equipped with the Steer-Ready pack, connection to a GPS receiver, such as the AGI-4, is essential. This enables you to obtain an exact track-to-track accuracy of just a few centimetres.



- ✓ Receiver AGI-4 for part-width section control and automated steering (optional equipment)

Cab management

Get in and drive off! But above all, stay relaxed



❗ “The cab [...] is spacious and pleasantly quiet. “”
(traction magazine “Working Test Pantera 4502-H” · 2/2015)

✔ The optional Category 4 filtered air cab ensures overpressure, so that penetration of dust and droplets is prohibited.

You will enjoy every working day...
... when you sit in this cab

Advantages of the cab:

- ✔ Superb sound insulation
- ✔ Convenient, wide access with hydraulically folding ladder
- ✔ Air-suspended comfort seat with many adjustment options*
- ✔ Additional mirror for best view of the front wheel
- ✔ Adjustable steering column
- ✔ Height and longitudinally adjustable arm rest with integrated controls
- ✔ Automatic air-conditioning
- ✔ Active carbon filter or Category 4* filtered air cab
- ✔ Electrically adjustable and heated exterior mirrors
- ✔ Additional mirror for best view of the front wheel
- ✔ Document compartment
- ✔ Large cool box under the passenger seat
- ✔ CD radio with Bluetooth hands-free telephone facility
- ✔ Sun blinds for front and rear windscreens

* Optional equipment

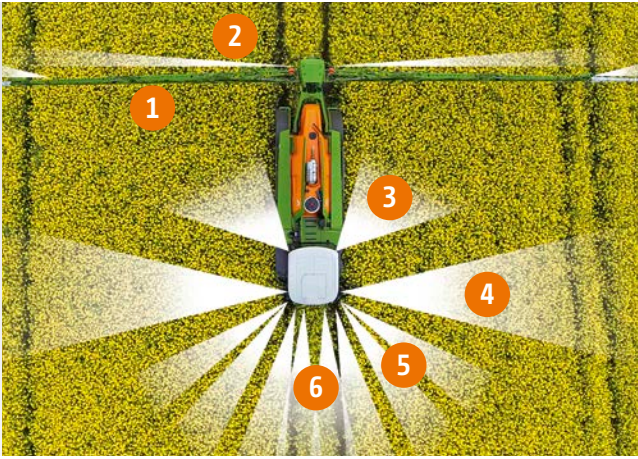

✔ Standard LED rear lights

By day and night - illumination for long and safe working days

- 1) LED individual nozzle lighting (option)
- 2) Work lighting (2 halogen spotlights)*
- 3) Boom work lights (2 halogen spotlights)*
- 4) Side-view work lights(2 halogen spotlights)*
- 5) Side work lights (4 halogen spotlights)*
- 6) Front headlights (4 halogen spotlights)*

* Lighting 2 to 6 optionally available as LED lights

❗ "... offers perfect all-round visibility"
(profi 11/2011)



Everything safely stowed!

The storage compartment under the cab offers sufficient space to store the suction hose, for instance, without problems. An additional, sealed clothing locker is located under the steps to the cab. A dust proof toolbox is also located under the access into the cab. Here, a hand wash tank and soap dispenser is also fitted.

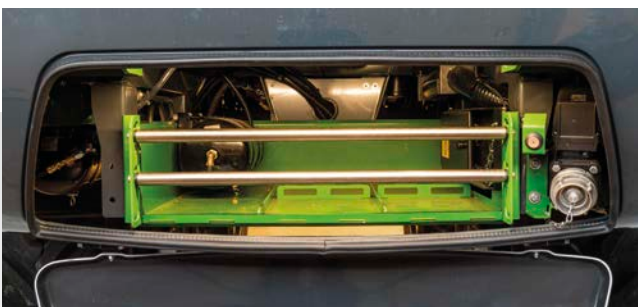

✔ Convenient and large – the compartment for the suction hose



✔ Sealed clothing locker under the cab

Operational management

Everything under control, everything to view – With the AmaDrive vehicle terminal

Control of the following functions:

- ✔ Cruise control
- ✔ Engine management with ECO or POWER mode
- ✔ Steering and headland management
- ✔ Track width adjustment
- ✔ Adjustment of the spray pump speed
- ✔ Control of the work lighting on the vehicle and booms
- ✔ Control of the central lubrication system

Display of:

- ✔ Forward speed and engine revs
- ✔ Fuel tank level and engine temperature
- ✔ Diagnostic data of engine and hydraulic system
- ✔ Field and road modes



- ❗ "The full overview means the AmaDrive touch screen provides the driver with the most important data"

(traction magazine "Working Test Pantera 4502-H" · 2/2015)

Camera systems

The pictures from the optionally available rear-view reversing camera and the camera for the right front wheel are also displayed on the high-quality colour screen.

- ✔ Large 135° viewing angle
- ✔ Camera with heating and lotus coating
- ✔ Clear picture even after dark thanks to infrared night vision technology
- ✔ Automatic back light function



AmaPilot⁺ multi-function joystick – Many functions to the one hand

“Get in and drive off“ is the motto! Drive the machine steplessly and intuitively using the AmaPilot multi-function joystick⁺. In cruise control, and with the maximum forward position of the multi-function joystick, the Pantera achieves speeds of up to 50 km/h on the road, and in the field, the pre-selected desired operating speed (the permissible maximum speed may vary, depending on the national road traffic regulations).

Pulling the driving lever backwards automatically activates the hydrostatic dual-circuit braking. This automatically actuated hydraulic auxiliary braking assists the driver in all situations. Maximum control when underway and when manoeuvring is guaranteed.

All functions of the sprayer can also be controlled with the multi-function joystick. In this way you can use AmaPilot⁺ for all functions of the steering management, the part-width section and boom control, additional functions such as end nozzle control as well as the +/- % application rate button.

Advantages of AmaPilot⁺:

- ✔ Perfect ergonomics
- ✔ Almost all the functions directly to hand via the 3 levels
- ✔ Adjustable palm support
- ✔ Freely-programmable and individual button allocation

❗ “The joystick fits in the hand perfectly “
(dlz magazine "Test report Pantera 4502"
2/2016)



✔ AmaPilot⁺ multi-function joystick

Intelligent spray liquid management: integrated into the total concept

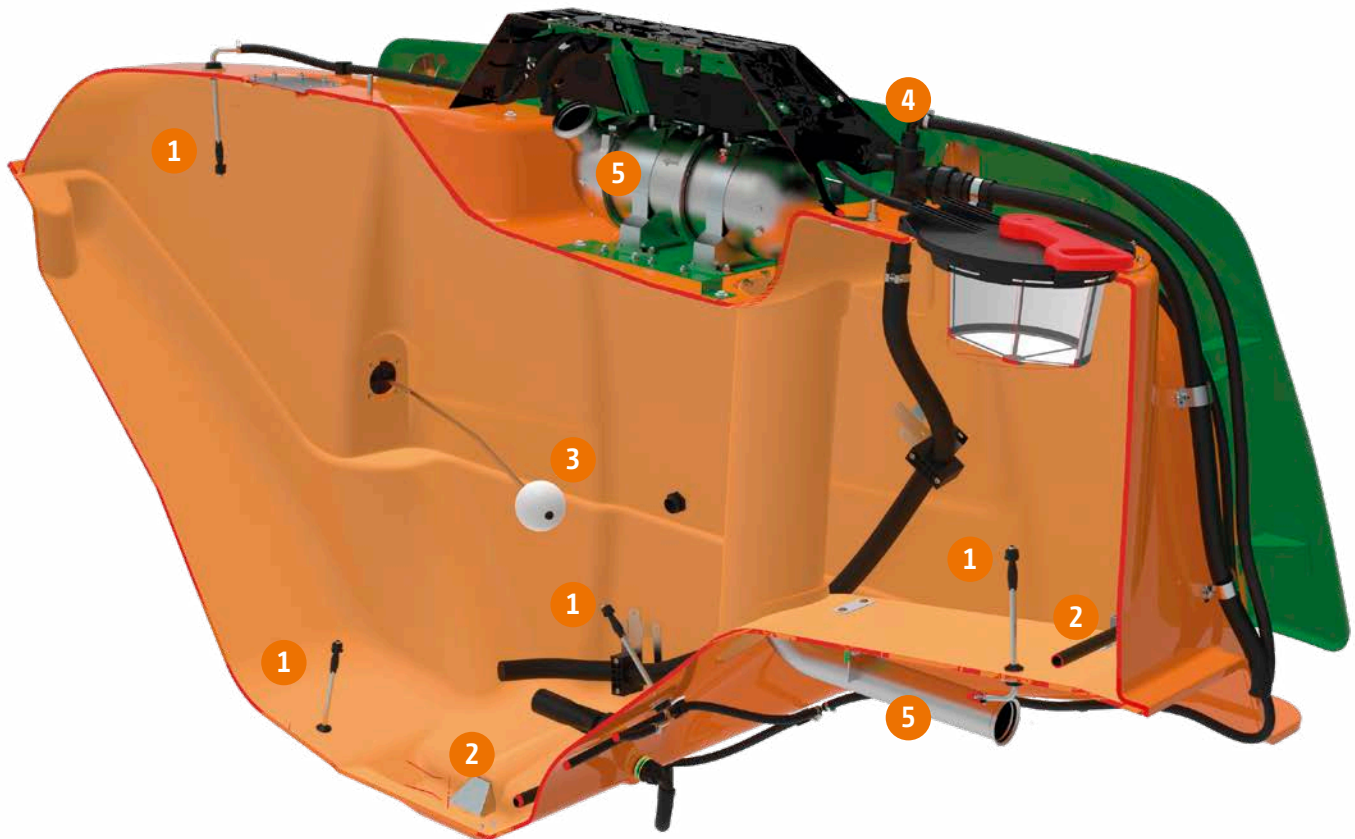

1) Cleaning nozzles
2) Agitator
3) Fill level sensor

4) Venturi
5) Exhaust gas system

Optimised for professional use

The 4,500 litre spray agent tank (actual volume 4,800 litre), deeply positioned in the frame, ensures a favourable centre of gravity and an even weight transmission on to all four wheels of the Pantera. The spray agent and fresh water tank consist of high grade glass fibre reinforced plastic with smooth internal and external walls. The low positioned outlet sump ensures smallest residual volumes even in sloping terrain. Electronic fill level indication and four rotat-

ing high-pressure nozzles for internal cleaning are standard. The 500 litre fresh water tank with fill level indicator is located at the rear of the Pantera.



High capacity pumps

The two high-capacity piston diaphragm pumps (520 l/min) ensure that it is also possible to spray at high water rates and at high forward speeds and yet sufficient agitator capacity is still available. The pump rotation speed from 380 to 580 rpm can be chosen in the AmaDrive terminal

External wash kit

A spray lance on a 20 m long hose is used to clean off the outside of the self-propelled sprayer immediately after work whilst still in the field. In addition, a 20 l hand wash container with soap dispenser is provided.

Bowser fill connection with automated fill stop

The automated fill stop prevents overfilling of the machine when drawing in via the suction hose as well as when filling under pressure. The bowser fill connection is located up front in the storage compartment, which allows pressure filling from the edge of the field without having to fold in the boom.

HighFlow - brings new levels in performance

To double the maximum application rates both the pumps can be switched into parallel. The HighFlow option opens up a new dimension in output.

- ✔ It allows large quantities of liquid fertiliser to be applied at higher speeds.
- ✔ For vegetable applications, then rates of 2,000 l/ha at 5 -6 km/h are possible.
- ✔ The large rates are only possible with an additional spray line giving twice the number of nozzles, placed 25 cm apart.



- ✔ Bowser fill connection in the storage compartment with automated fill stop

- ✔ HighFlow ensures that the two pumps are switched in parallel to double the maximum application rate

The operator station: well organised and automated



The operating components of the Pantera with Comfort-Pack 2

- | | | | |
|---|--|--|---|
| 1) Drip-free coupling port
Suction side* | 5) Auxiliary agitator | 10) Suction filter | 14) Control valve induction bowl
draw out |
| 2) Self cleaning pressure filter | 6) Quick emptying | 11) Pump | 15) Hand lance pistol for rinsing out the
induction bowl |
| 3) Button for spray agent pump | 7) 3" suction port | 12) Button for lifting
the induction bowl hydraulically* | |
| 4) Fresh water fill port | 8) Comfort-Pack 2 remote display* | 13) Control tap for induction bowl
draw out/Venturi fast fill | |
| | 9) Electrically-controlled pressure
valve | | |

* Optional equipment



Comfort-Pack 1 with TwinTerminal

Comfort-Pack 1

With the Comfort-Pack, the Pantera features professional equipment for the automation of the spray agent liquid circuit. The most important functions of the liquid circuit (filling, agitator intensity and cleaning) are performed by remote control using the operator terminal and the TwinTerminal.

Advantages of Comfort-Pack 1:

- ✔ Automatic fill stop: convenient and accurate!
- ✔ Operation via the TwinTerminal
- ✔ Automatic agitator control prevents foaming and ensures minimal residual spray volumes
- ✔ Remote-controlled, automated cleaning from the cab

Induction bowl and power injector

A rinse ring in the lip of the induction bowl plus additional nozzles dissolves powdered active ingredients and allows sizeable quantities of urea to be quickly and reliably inducted directly through the venturi. Use of the rotating nozzle in the canister rinsing system ensures easy cleaning of the spray agent canister and full use of the canister contents. The closed induction bowl can be rinsed for self-cleaning purposes. When closed, the lid of the induction bowl is sealed, so that no dirt can penetrate into the system.



Comfort-Pack 2 with remote display at the operator station

Comfort-Pack 2

Comfort-Pack 2 with additional fresh water pump; for more comfort during filling and washing out is faster, cleaner and even easier. All functions of Comfort-Pack 2 are operated through the AmaDrive vehicle terminal. An additional display at the operator station helps input the desired fill levels from ground level.

Additional advantages of Comfort-Pack 2:

- ✔ Additional fresh water pump
- ✔ Continual fresh water at the canister rinse nozzle
- ✔ Continual fresh water at the external wash kit
- ✔ Completely automatic cleaning procedure with continuous internal cleaning



❗ "The induction bowl is so comfortable to operate."

(dlz magazine "Test report Pantera 4502" 02/2016)

Super-L booms

super-stable, super-light and super-compact

Pantera – with clever intelligence

The two Super-L booms reveal their extraordinary qualities in the Pantera self-propelled sprayer. The special AMAZONE profile design makes the two booms not only light and extremely robust, but also highly compact. Premium boom quality ensures a long service life even when working at very high work rates.

Your benefits:

- ✔ Wide height adjustment range of 0.50 m to 2.50 m
- ✔ Central pendulum adjustment and hydraulic tilt adjustment of the boom provide smooth boom travel even at high speeds

- ❶ “The four-fold boom neatly lies tight to the tank.”

(profi 11/2011)

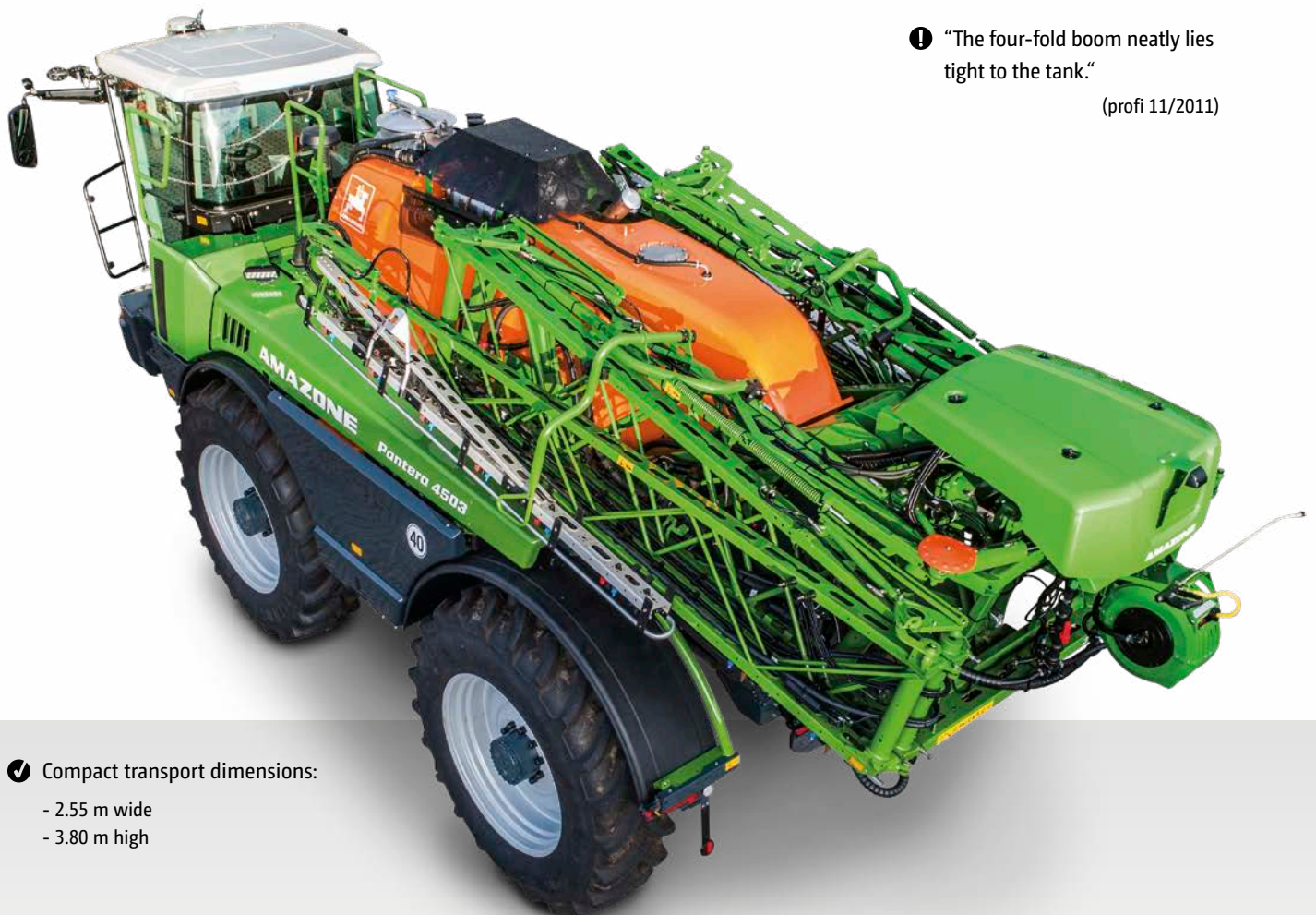

✔ Compact transport dimensions:

- 2.55 m wide
- 3.80 m high



✔ The hydraulic fittings made from stainless steel ensure a long service life and a high resale value.



✔ A pivot joint that lasts!



"The 4-fold damped Super-L booms – Smooth-travelling and exact as standard"

Boom guidance of the Super-L boom is optimised by the central pendulum suspension. In addition, the combined spring and damping elements provide an enormous reduction in any potential vertical movement. Also the horizontal pivoting movements are kept at a minimum by the integrated damping system so that, for all AMAZONE booms, optimum work results are achieved.

The benefits:

- ✔ a particularly long central pendulum system means parallel guidance of very wide booms
- ✔ combined spring and damping elements for shock-dampening the suspension against vertical forces,
- ✔ integrated damping system consisting of braking plates and buffer blocks to damp down the horizontal yaw movement.
- ✔ leaf springs absorb the movements in the driving direction (from 39 m boom width)

Super-L boom suspension

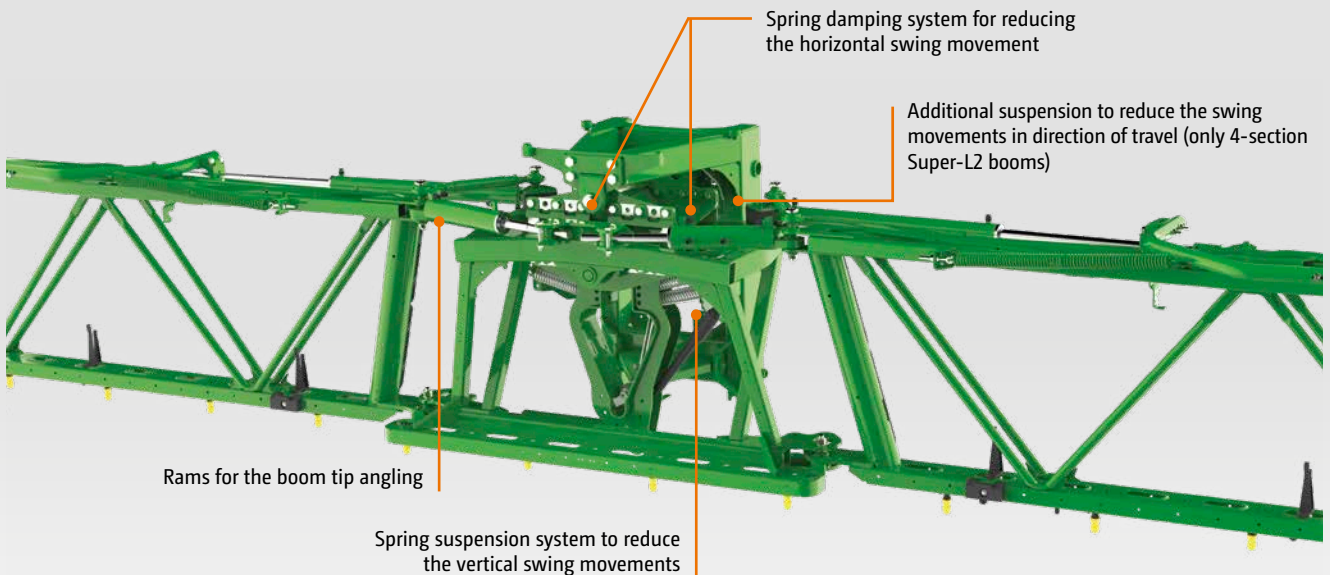



39 m Super-L2 boom

Super-L2 boom in working widths from 21 to 40 metres

Even with the maximum boom width of 40 m, the transport width of the Super-L2 boom is only 2.55 m. In the transport position, the boom is behind the cab. This means: no limitations in the field of vision for the driver and no liquid dripping in and around the cab area.

❗ “The booms can be folded in either side independently or both sides together. This means that a variety of tramline widths can be covered making it the ideal solution for contractors”
(dlz "Test report Pantera 4502" 2/2016)

40/32/23/12		8-9-9-9-10-9-9-9-8
39/32/23/12		7-9-9-9-10-9-9-9-7
36/30/24/12		6-7-9-10-9-7-6
36/28/19/10		9-9-7-7-8-7-7-9-9
33/27/21/12		7-8-7-7-8-7-7-8-7
33/26/19/10		7-8-7-7-8-7-7-8-7
32/26/19/10		8-6-7-7-6-7-7-6-8
30/24/15/8		8-7-6-6-6-6-6-7-8
28/22/15/8		7-6-6-6-6-6-6-6-7
28/19/10		9-7-8-8-8-7-9
27/22/15/8		6-6-6-6-6-6-6-6-6
27/21/15/8		8-7-8-8-8-7-8
27/19/10		8-7-8-8-8-7-8
24/19/10		6-6-8-8-8-6-6
21/15/9		6-6-7-4-7-6-6

Number of nozzles / part-width section
Other divisions possible



36 m Super-L3 boom, usable at both 24 m and 12 m as well

Super-L3 boom in 36 m working width

The Super-L3 boom supplements the 36 m working width Super-L2. The outer and middle boom sections each have a length of 6 m, so that the Super-L3 boom is made up of only 3 sections each side. This makes it possible to use the 36 m Super-L3 boom also at a reduced working width of either 24 m or 12 m. The end boom sections come fully constructed in aluminium with additional bracing bars. This ensures very high robustness yet with a very low weight. As standard, the hydraulically pressurised break back system on the boom end can evade obstacles from the back, front or from the top. The advantage of the hydraulically pressurised break back, that works similar to the saloon door principle, lies in the constant release forces across the whole protected area. It furthermore guarantees return back to the working position under all conditions with the minimum of wear.



Hydraulically pre-tensioned break back joint at the boom end which works on a saloon door principle



Flex-fold

The outstanding made easy



Flexible, fast and accurate

Flex-folding

AMAZONE offers two electro-hydraulically boom folding options, Flex-fold 1 and Flex-fold 2. Each boom folding joint is equipped with an electro-hydraulic valve block that is directly controlled by the machine software. This enables faster folding procedures. As soon as the first boom section is folded in or out by approximately 70%, the next section automatically starts to fold in or out.

Individual user profiles for reduced working widths

Via the user profiles in the machine software, individual profiles that recognise a reduced working width can be stored. If, for instance, it is intended to fold out a 36/30/24 m boom to just 30 m, this can be carried out quickly and simply via a profile change. After folding out just the relevant sections, the active working width is automatically detected and the outer nozzles are automatically deactivated via AmaSwitch or AmaSelect. For section control, the working width is automatically stored.

Flex-folding 1

In addition to the benefits already outlined, Flex-fold 1 provides the following extra functions:

- ✔ Height adjustment,
- ✔ Folding in and out,
- ✔ Independent fold at reduced forward speeds (max. 6 km/h),
- ✔ Boom width reduction,
- ✔ Tilt adjustment

Flex-folding 2

In addition to the advantages mentioned previously, Flex-fold 2 offers the following functions:

- ✔ Positive boom angling of individual / both sides
- ✔ Negative boom angling of individual / both sides

- ❗ "To speed up the folding procedure, AMAZONE has replaced the simple sequence control by a sensor controlled process. With this we clocked a quick 19 seconds for folding out and 27 seconds for folding in – great!"

("profi" – Test report Amazone UX 5201 Super - 10/2017)

Automated boom height control

With maximum comfort and even more precision

AutoLift, DistanceControl or ContourControl? Decide for yourself!

The AutoLift, DistanceControl and ContourControl automatic boom guidance systems offered by AMAZONE provide a suitable solution for every need. Just utilising the standard AutoLift already provides convenient assistance. The fully automated DistanceControl boom guidance leaves the boom control almost completely in the hands of the machine.

The innovative ContourControl boom control is AMAZONE's high-end solution, ideal for customers with difficult terrain conditions. In addition to fully automated height guidance, ContourControl also offers active vibration damping for the boom. Contour-Control satisfies the demand for higher accuracy, even at faster forward speeds.

✔ Automatic boom lowering in GPS-Switch

In GPS-Switch, the booms can be activated to start to already lower prior to reaching the untreated areas. This means that, when the nozzles open, the booms are already at the correct

working height. Requirements for this function are just a field boundary saved within the GPS-Switch in the AMAZONE ISOBUS terminal.

AutoLift – the automatic comfortable headland system

AutoLift automatic boom lift (standard equipment) lifts the boom to the pre-selected height every time the machine is switched off. It lowers back down again to the target height

when the sprayer sections are switched on. This reduces the risk of damage to the boom while turning on the headland.

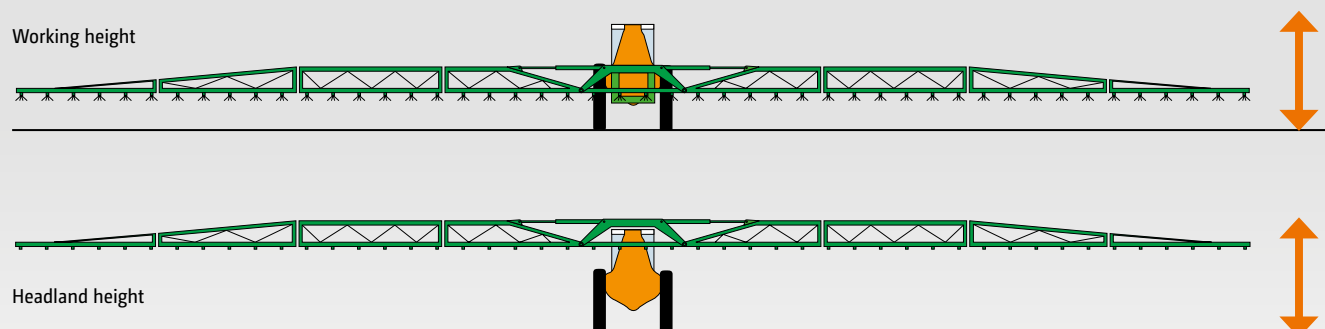

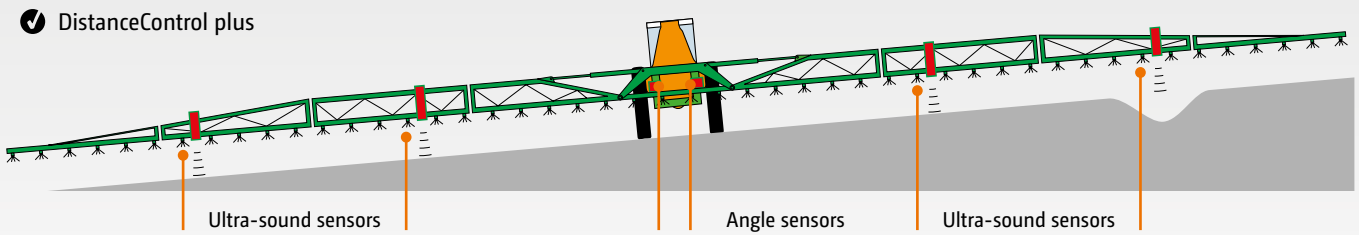

DistanceControl with 2 sensors or DistanceControl plus with 4 sensors

AMAZONE offers for Super-L booms, either DistanceControl fully automated boom control with 2 sensors or DistanceControl plus with 4 sensors on the Pantera self-propelled sprayer. In heavily differing crop heights, or in areas with partially lodged corn, it could be that the boom, when equipped with 2 sensors, dips into the crop. In this case equipping the boom with four sensors will prevent this. The sensors are electrically connected in parallel and so it is always the sensor that is closest to the target surface that is actuated.

The driver is able to concentrate on correctly applying plant protection agents and the computer optimises the boom height control!

Benefits of the DistanceControl boom guidance

- ✔ Fully automatic boom guidance including height guidance, tilt adjustment and boom lifting on the headland
- ✔ Automated bilateral boom angling (in combination with Flex-fold 2)



Sensors precisely detect the target height distance and take over the operation.

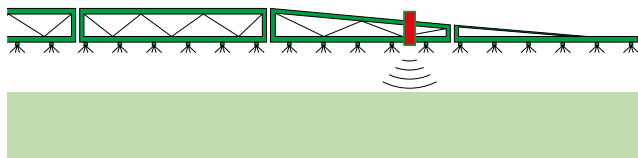

DistanceControl when equipped with two sensors: measuring to the crop

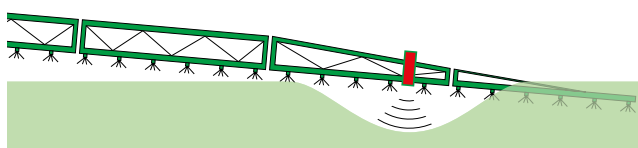

DistanceControl when equipped with two sensors: The boom can dip into the crop, for example, where there is lodged corn

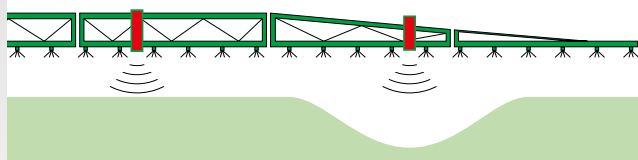

DistanceControl plus: offers the remedy in those more difficult conditions with its four sensors

Vertical boom movement

AMAZONE booms ensure that smooth, vertical boom ride

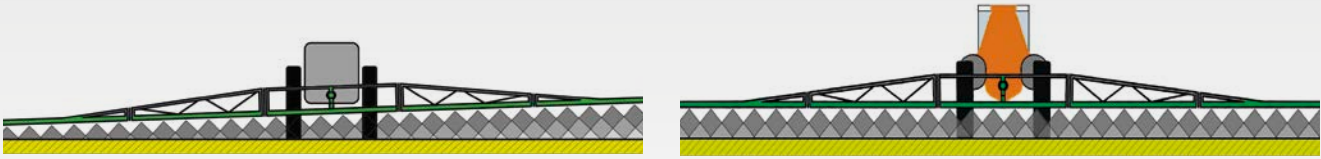

ContourControl – reduces those vertical boom movements

The AMAZONE ContourControl active boom control is a trendsetting and fully automated boom control system for booms widths from 21 m. This fulfils the demand for higher precision during application due the lower target surface distances even at high forward speeds. ContourControl can be used with Super-L booms in conjunction with either Flex-fold 1 or Flex-fold 2.

The basis of the new boom guidance is the highly-responsive, electro-hydraulic system with either 4 sensors or in, combination with the Flex-fold 2, 2 additional sensors which allow control of any negative geometry.

The benefits of the active ContourControl boom guidance:

- ✔ Best possible fully automatic vertical boom guidance – even in those difficult conditions
- ✔ Automatic independent boom angling (in combination with Flex-fold 2)
- ✔ Very quick folding procedures
- ✔ Higher accuracy at faster working speeds
- ✔ Elegant boom control for those wider working widths

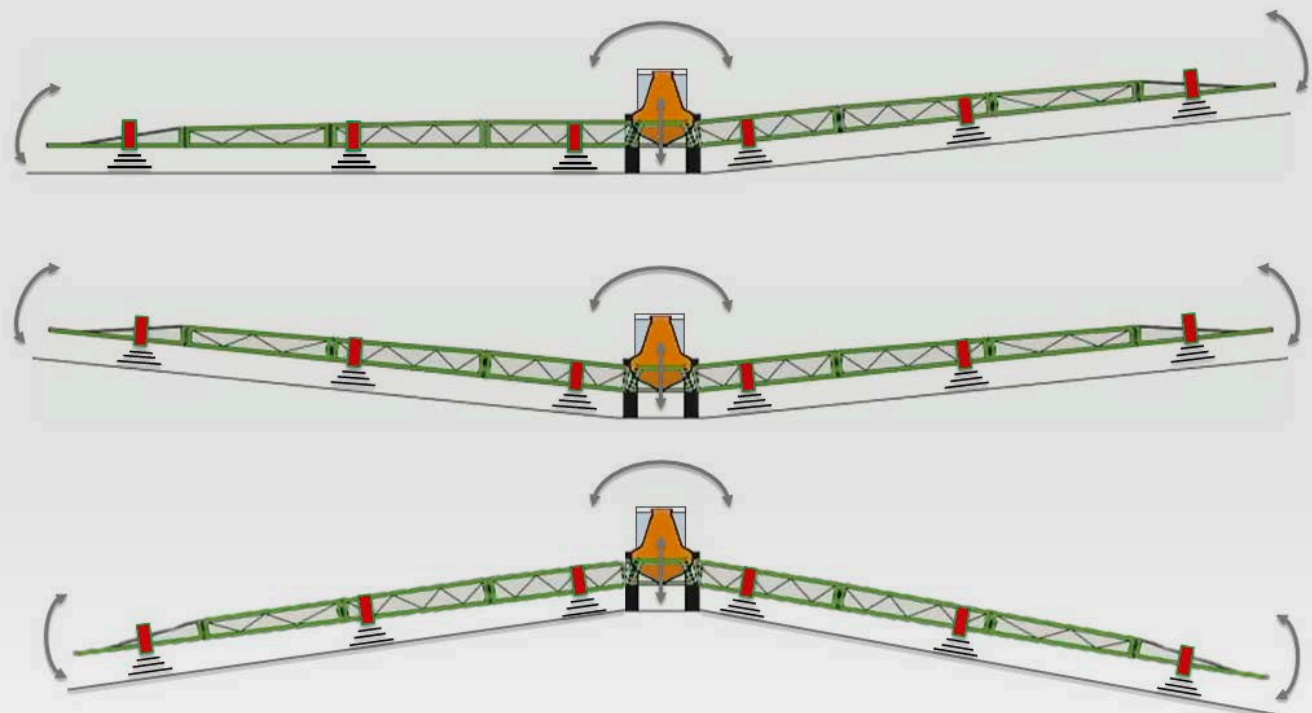

Horizontal boom movements

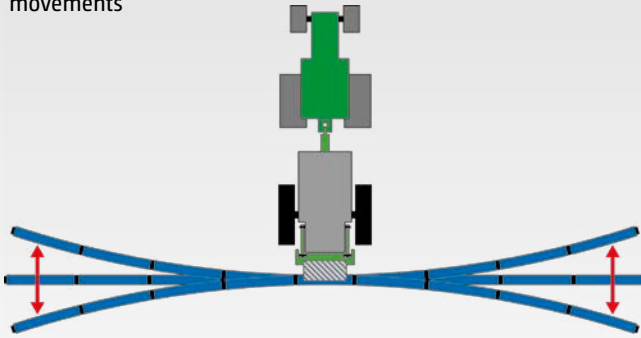

AMAZONE booms with SwingStop for excellent horizontal boom guidance

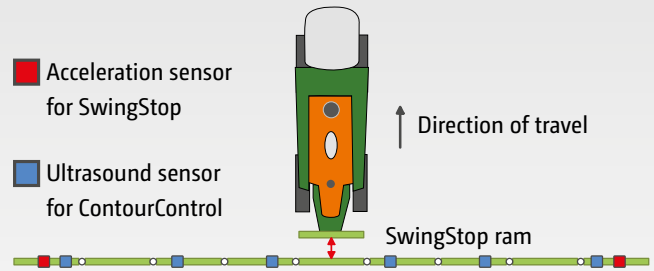

SwingStop – for reducing the horizontal boom movement

For matching the horizontal boom ride to the increasing demands, such as, for example, wider working widths and higher forward speeds, AMAZONE offers, as an option for the ContourControl boom guidance system, the active SwingStop boom tip movement prevention. By external influences, such as ground undulations, driving round bends, acceleration and deceleration and increasing operating speeds the boom is extraordinarily strained in horizontal direction. This may result in the boom ends swinging round and thus negatively affecting the lateral distribution at the outer ends of the booms.

As horizontal movement occurs more at the boom ends, this effect is increased enormously by wider boom widths. To reduce this horizontal swing effect, SwingStop measures, via acceleration sensors, the resulting acceleration at the boom ends. The two actively-operating hydraulic rams in the boom suspension compensate live for these swing movements and in this way provide a very smooth horizontal boom ride.

The benefits of SwingStop:

- ✔ Reduction of the horizontal boom movement
- ✔ A system that operates very quickly, elegantly and precisely
- ✔ Highest performance and outstanding precision

Boom guidance – Discover all the possibilities

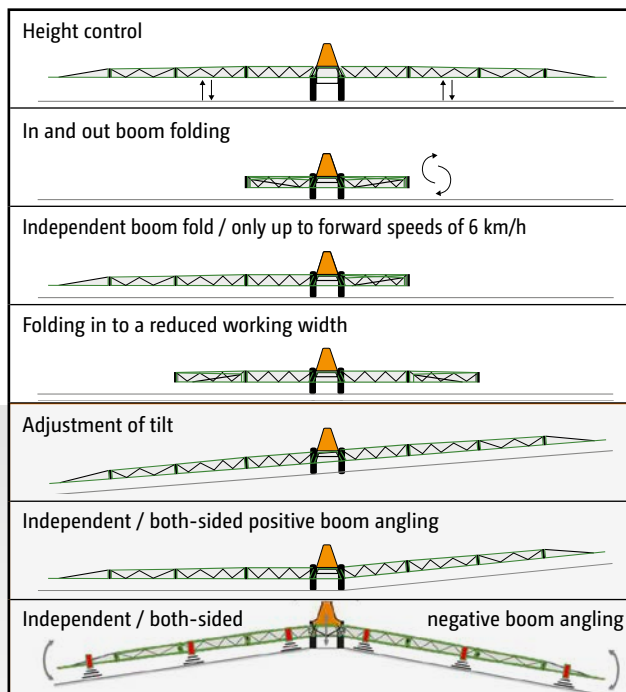

Flex-fold 1

Flex-fold 2

	Standard	with Distance-Control	with Contour-Control	Standard	with Distance-Control	with Contour-Control
Height control						
In and out boom folding						
Independent boom fold / only up to forward speeds of 6 km/h						
Folding in to a reduced working width						
Adjustment of tilt						
Independent / both-sided positive boom angling						
Independent / both-sided negative boom angling						

DUS and DUS pro pressure re-circulation systems



Pressure recirculation system (DUS)

With DUS you determine the timing

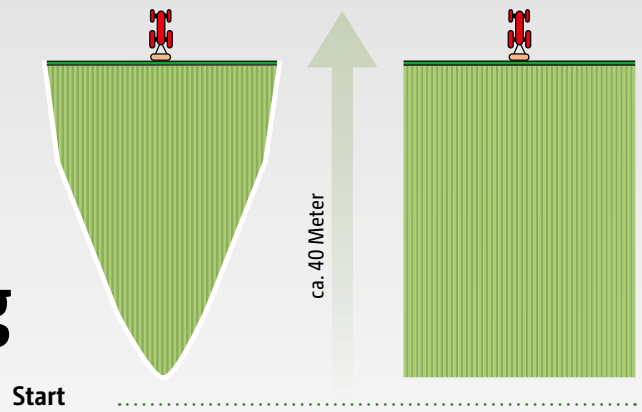

Start

without DUS

with DUS Immediate coverage the full working width

The DUS pressure recirculation system – proven more than 10,000 times

The DUS pressure re-circulation system from AMAZONE guarantees the reliable recirculation of the whole system. At the start of the job, the hose system including the spray line is first filled with the active ingredient solution under pressure and in the reverse direction. This means the spray lines are always full and immediately ready to use over the entire working width. There is no waiting on the headland.

Every time individual part-width sections are shut off, during the turning operation and during transport, the spray liquid circulates continually thanks to the pressure recirculation system. This reliably prevents deposits, blockages or segregation in the spray lines.

During the cleaning operation, fresh water flushes the spray lines out right up to the nozzles without any spraying being necessary. During this cleaning procedure the concentrated spray liquid is returned back to tank via the pressure recirculation system leaving the spray lines clean.

DUS pro

DUS pro high pressure circulation is fitted as standard on AMAZONE self-propelled sprayers equipped with either AmaSwitch or AmaSelect electrical single nozzle control. The spray pressure at each individual nozzle is constant. Thanks to the conical spray lines, minimal residual spray volumes are achieved.

Conical spray line:

- ✔ The dimensions of the spray line vary along the boom
- ✔ Minimum residual volumes
- ✔ Even flow speed

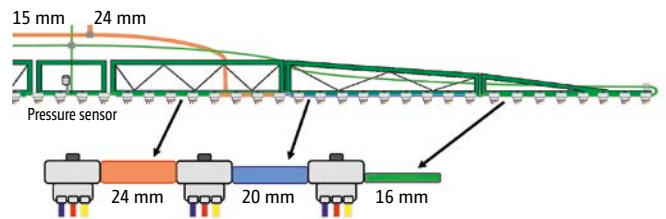

DUS pro high pressure recirculation with conical spray line on here, for example, AmaSwitch

DUS pressure recirculation system: supplies each individual part-width section

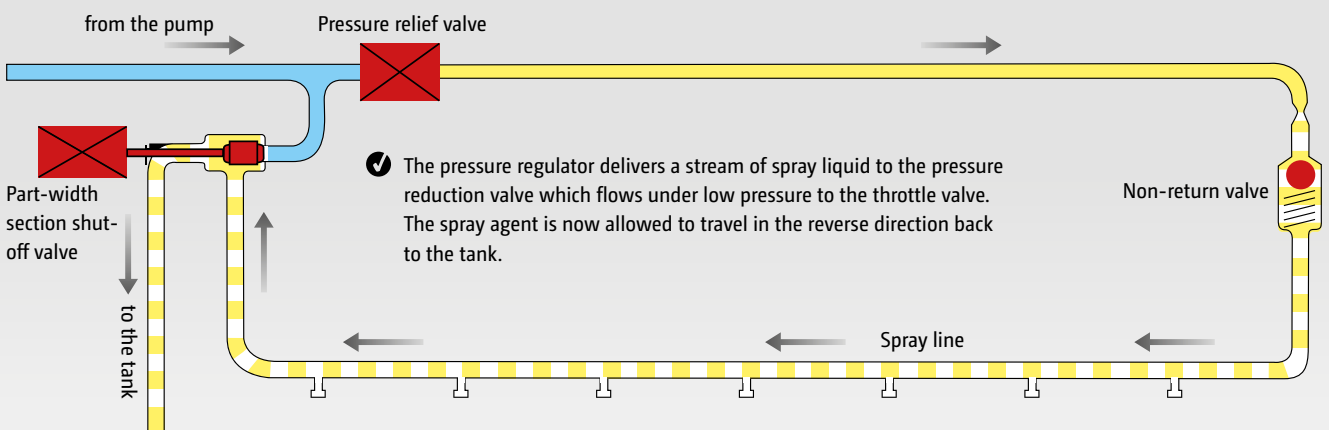

Part-width section controls

Electrically-controlled TG valve chest

The TG part-width section valves are actuated via the ISO-BUS control. The part-width sections are switched quickly and without drips using the electric motor valves with pressure release valves. In all situations the spray rate is exactly and quickly controlled directly via the computer and so negating the need for any mechanical equal pressure control.



Electric individual nozzle control with actual 50 cm part-width section control

Even today, many crop protection sprayers in the market feature a normal part-width section valve chest. Here the classic part-width section often is 3 to 5 m wide. If using part-width sections manually operated by the driver, specifying smaller part-width sections often does not make sense due to the inaccuracy of the switch points. Thanks to automatic part-width section switching via Section Control, today more precise switch points are achieved so that, by utilising even smaller part-width sections, valuable crop protection agents are saved. With AmaSwitch and AmaSelect, AMAZONE offers two very precise solutions for 50 cm part-width section control.

The systems in comparison:

Your benefits	TG part-width section valves	Electrical single nozzle control		
		AmaSwitch 3-fold	AmaSwitch 4-fold	AmaSelect
Multiple boom sections	up to 13	up to 80	up to 80	up to 80
50 cm part-width sections	–			
Number of nozzles per nozzle body	1, 3, 4	3	4	4
Manual nozzle switching				–
Automatic nozzle changeover and switching	–	–	–	
Nozzle selection from the cab	–	–	–	
Nozzles used in combination	–	–	–	
High pressure recirculation (DUS pro)	–			
25 cm nozzle spacing		–		
Individual programming of the part-width sections (TB)	–			
No need for compressed air				
LED individual nozzle lighting				



✔ AmaSelect electric individual nozzle control

Important field analysis knowledge

- ✔ Average overlap with 50 cm part-width sections only 1.92%
- ✔ Average overlap with 9 part-width sections 7%
- ✔ Short payback period for large farms due to annual saving potential
- ✔ Due to smaller field sizes, smaller farms save proportionally more
- ✔ When growing crops with a high crop protection demand (e.g. potatoes, beet), the 50 cm part-width section is particularly cost-effective

Calculated example:

Annual average overlaps of conventional part-width sections vs 50 cm part-width sections in combination with Section Control

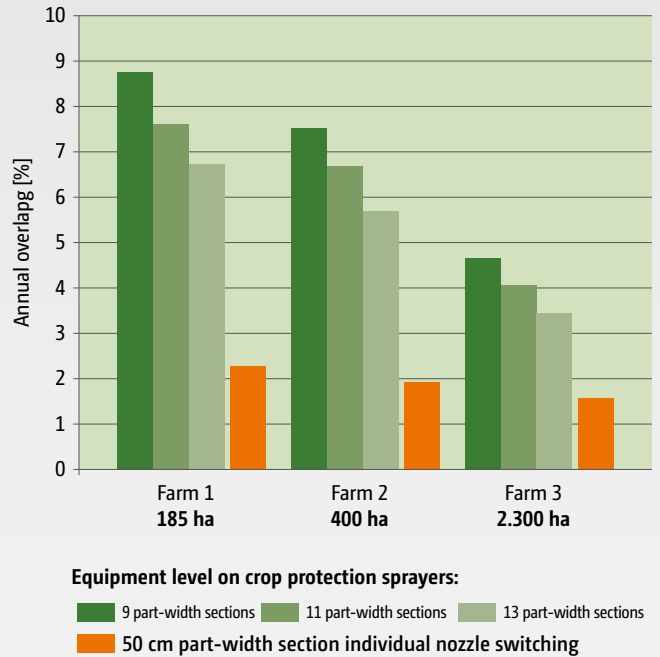

Example: 24 m boom width

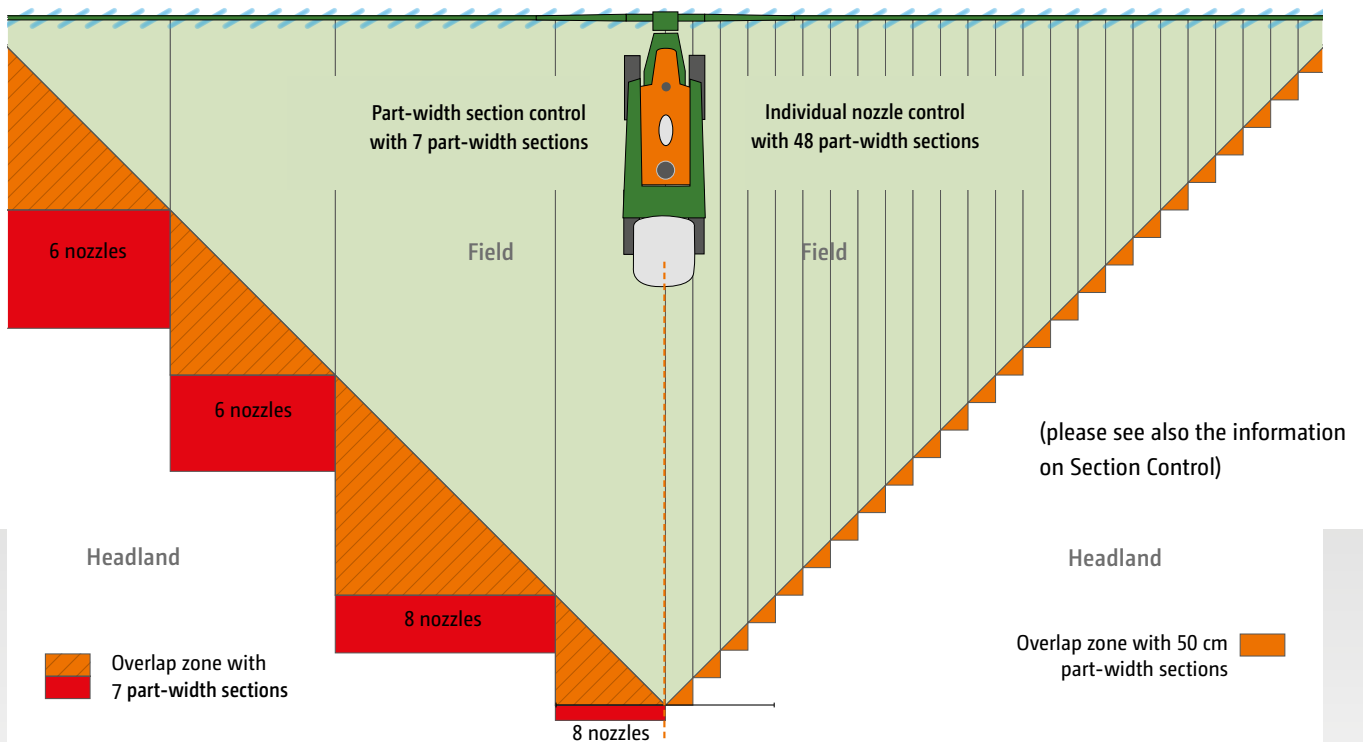

AmaSwitch

Electric individual nozzle switching with 50 cm part-width sections



AmaSwitch 3-fold nozzle body

Automatic 50 cm part-width section switching

With AmaSwitch, AMAZONE offers the precise solution for automatic part-width section control on 50 cm sections. AmaSwitch is the ideal alternative for users who want to maximise the benefits of very precise switching in wedge shaped fields and areas of overlap, thanks to the 50 cm part-width section control.

Standard equipment with AmaSwitch includes the DUS pro high pressure recirculation system and, in addition, can be equipped with LED individual nozzle lighting.

3-fold nozzle body, with electric on/off switching

The technology behind AmaSwitch is based on a conventional, manually-rotated, 3-fold nozzle body with electric individual on/off. The opening and closing is achieved via an electric valve which is fixed directly onto the nozzle body. In conjunction with GPS-Switch, it is thus possible to very precisely control 50 cm part-width sections in short work and on the headland. In addition to the automatic switching using 50 cm part-width sections, it is possible to configure the amount of part-width sections from choice.

4-fold nozzle body, with the additional 25 cm nozzle spacing

In addition to the 3-fold nozzle body, the electric AmaSwitch individual nozzle switching can be also equipped with a 4-fold nozzle body. With the 4-fold nozzle body, all the benefits of the electric AmaSwitch individual nozzle switching are maintained as with the 3-fold nozzle body but, in addition, with the aid of the optional extension set, an actual 25 cm nozzle spacing can be utilised. This offers the benefit, in combination with specific 80° nozzles, to reduce the boom to target surface distance down to less than 50 cm.



AmaSwitch 4-fold nozzle body

AmaSwitch with 4-fold nozzle body and extension set for an actual 25 cm nozzle spacing

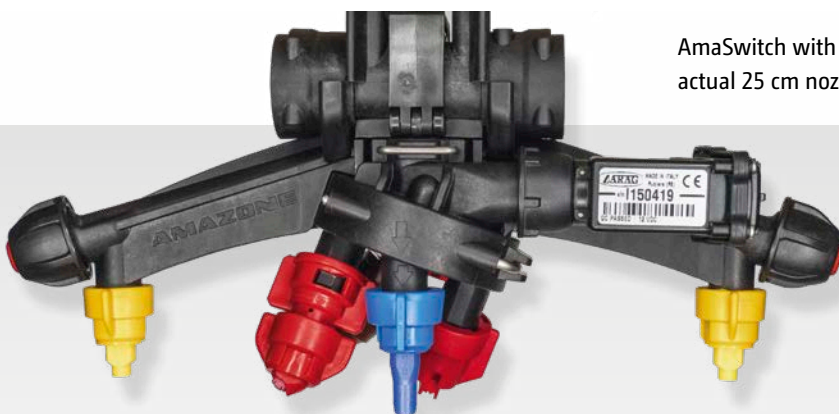

AmaSelect

Electric individual nozzle switching with 50 cm part-width sections

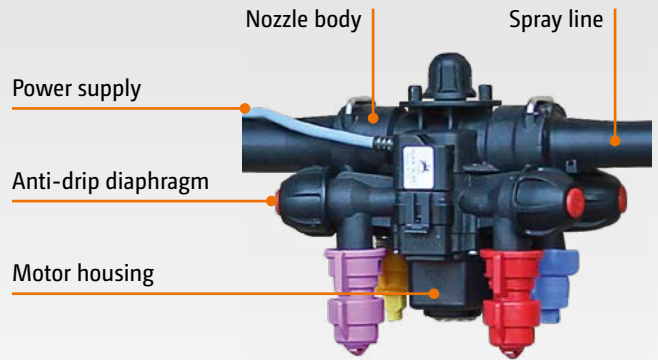

AmaSelect – components of the system

Modern application technology

The electric AmaSelect individual nozzle control consists of a 4-fold nozzle body with electric on/off control plus the additional switching over of either a nozzle or a combination of nozzles. So, the system, in addition to the 50 cm boom part sections which can be switched automatically via GPS-Switch, offers a changeover electrically between the four fitted nozzles via the operator terminal or, when required, completely automatically. Via the input of the optimum pressure range of each individual nozzle within the 4-fold nozzle body, the system automatically switches the nozzles according to these specifications. This offers the possibility, for instance when leaving the optimum pressure range of a nozzle, to switch on a second nozzle or to changeover to a larger nozzle. It is possible, how-ever, to freely configure any number of part-width sections with also any number of nozzles. Just for farmers or agricultural contractors with different tramline systems, a simple matching of the nozzle switching with the relevant working width is possible. As standard, AmaSelect is equipped with DUS pro high pressure recirculation and LED individual nozzle lighting.

HeightSelect

With the aid of HeightSelect (only in conjunction with AmaSelect and ContourControl) now also the distance between boom and the targeted crop is continuously matched automatically in relation to the nozzle spacing and nozzle type. When the nozzle has been switched on, the automatic boom guidance system controls the appropriate target distance. This automisation improves the efficiency of the crop protection agent used as well as decisively relieving the stress on the driver.

With 50 cm or 25 cm nozzle spacing

As an option, the AmaSelect nozzle body can also be equipped with an off-set kit giving 25 cm nozzle spacing. This, in conjunction with special 80° nozzles, offers the benefit of reducing the target height above crop to below 50 cm. In addition, this version can be supplemented by the HighFlow option for applications with extremely high application rates.

Principle of function: HeightSelect

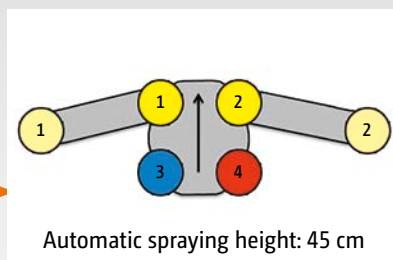
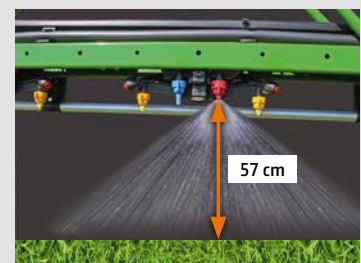
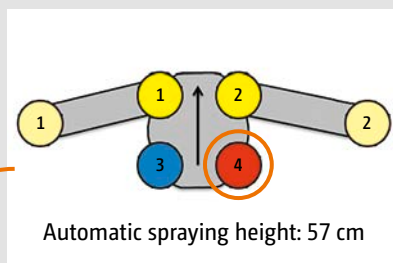

Electric boundary nozzle switching

For environmentally-friendly spray application at the field edge

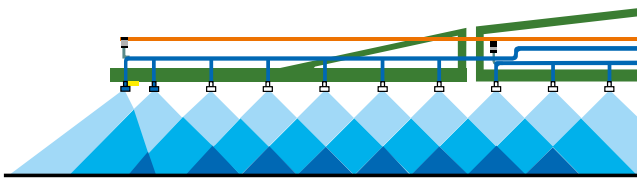

Additional nozzle switching

In order to extend the normal working width, an asymmetrical nozzle can also be switched on. This is particularly useful if the distances between tramlines are not precise enough.

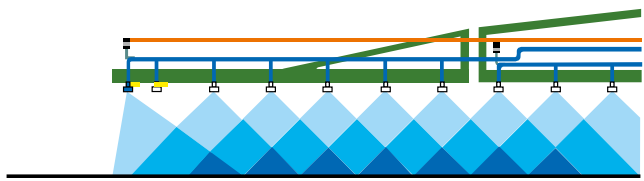

Boundary nozzle switching

For precision border spraying between two sensitive crops, the boundary nozzles can be used to make sure the spray pattern is accurately defined.

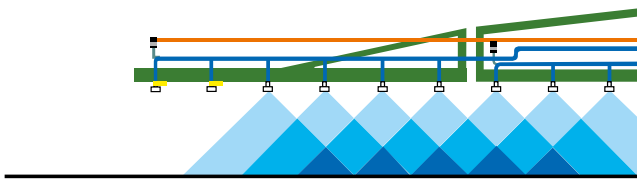

End nozzle switching

If a one metre buffer zone around the edge of the field needs to remain unsprayed due to distance constraints, end nozzle switching can be used.

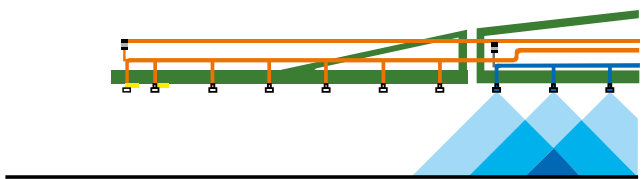

Outer part-width section switched off - DUS is active

Direct electric control of the boundary nozzles. Every nozzle body is integrated in the DUS circulation!



Liquid fertilisation & under-leaf spraying – Mature solutions for high outputs

Liquid fertilisation

AMAZONE sprayers are particularly suitable for using liquid fertiliser: the use of high-quality plastics, the good paint finish and the almost exclusive use of stainless steel secure a long life-span, even when liquid fertiliser is used.



✔ Drag hose kit with stainless steel weights

Multi-hole nozzles

For the distribution of liquid fertiliser in coarse droplet size, either multi-hole nozzles (3 or 7 hole) or the FD sluice nozzles are available on request.



✔ 7 hole nozzle

Under-leaf spraying

Also elegant solutions for successful under-leaf spraying are possible in combination with AMAZONE plant protection sprayers. The Dropleg system from Lechler is a freeswinging, under-leaf spraying device that works across the rows and is an example of an easy and robust solution that fulfils the most professional of demands.



✔ Dropleg system

The right nozzle choice

The basis for success in crop protection



Less drift also at higher wind speeds

With the air-assisted injector nozzles, crop protection agents can be applied with very little drift. They are universally usable in all crops and all classifications. Because of the coarse droplet application, these nozzles can also be used in higher wind speeds.

AMAZONE offers a wide range of nozzles from agrotop, Lechler and TeeJet.

Single and multi-nozzle bodies

The nozzle bodies with integrated diaphragm non-return anti-drip valves fit up into the boom profiles reliably preventing any dripping at the nozzle. Self-adjusting bayonet fixings ensure a tool-less quick nozzle change. The 3-fold or 4-fold nozzle bodies are suited to frequent nozzle changes due to different applications and crops. Nozzle protection tubes, as standard on the outer sections, or, if desired, over the entire boom working width, ensures protection for long injector nozzles and multiple nozzle bodies.





Examples

- 1) Lechler IDN 120-025
- 2) Teejet XRC 110-025
- 3) Air-injection nozzle
AirMix 110-04



Everyone purchasing an AMAZONE crop protection sprayer receives, free of charge, an AMAZONE nozzle mounting tool that enables a much easier nozzle change.

Injector nozzles (ID, TTI) have a relatively coarse droplet spectrum and are particularly versatile with regard to their field of application. A pressure range of 2 to 8 bar is possible.

If coverage quality is at the foreground of the application, the use of standard or anti-drift fine droplet nozzles, such as XR or AD, is recommended. Special care is required here due to the tendency to drift above 3 bar.

A good compromise is provided by the modern ID-K or Airmix compact injector nozzles. These have relatively little drift, but do not have too coarse a droplet spectrum and are operated at 2 to 4 bar.

When it comes to special coverage qualities the double flat

fan nozzle is an interesting alternative: the AVI Twin from Agrotop also produces droplets that are not too fine. The split spray pattern ensures a more even deposit on the front and back of the plant and makes sense maybe, for example, in ear treatment.

For speeds greater than 10 km/h, the TD HiSpeed nozzle with its asymmetrical spraying angle is becoming a new industry trend.

Distribution of the droplet size

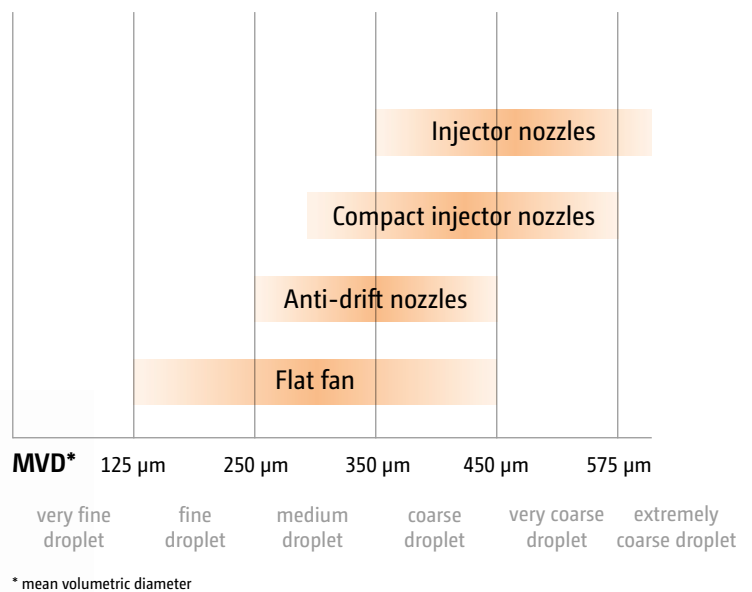

ISOBUS –

Machine actuation in the digital age

MEMBER OF



One language, many benefits!

Each ISOBUS-enabled machine from AMAZONE comes with the latest technology and almost unlimited possibilities. It does not matter whether you use an operator terminal by AMAZONE or an ISOBUS terminal directly installed in your tractor. ISOBUS is a worldwide recognised communication standard between, on the one hand, operator terminal, tractor and connected implements and, on the other hand, agricultural office software.

Operation with any ISOBUS terminal

Which means that ISOBUS enables you to take control of all your ISOBUS compatible equipment. You just connect the machine with the relevant ISOBUS terminal and immediately the normal operator interface is displayed on the monitor screen in your tractor cab.

Benefits of ISOBUS:

- ✔ This worldwide standard provides a uniform interface and data exchange formats that ensure the compatibility even with third party manufacturers
- ✔ Plug and Play between machine, tractor and additional ISOBUS implements



AMAZONE – more than just ISOBUS

Improved control, more yield! Precision Farming 4.0

Our competence in electronics

To increase the operational comfort, AMAZONE implements and operator terminals feature a scope of functionality way beyond ISOBUS standards.

The benefits of more than just ISOBUS:

- ✔ Highest compatibility and safety functionality of your ISOBUS equipment
- ✔ No additional modules on the machine side. All ISOBUS machinery from AMAZONE is already equipped as standard with the necessary ISOBUS functions
- ✔ MiniView display with all AMAZONE terminals and additional ISOBUS terminals. See, for instance, the machine data in the GPS view
- ✔ The possibility using the tractor terminal or in a twin terminal solution to separate the functionalities of tractor and connected implement
- ✔ Unique operation concept. Freely-configurable displays and individual user interfaces in the operator terminal
- ✔ Up to 3 user profiles are possible. Establish for every driver or operation an individual user profile!
- ✔ Freely-configurable machine operation as, for instance, the folding procedure of the booms of your AMAZONE crop protection sprayer
- ✔ Tractor ECU function evaluation
Automated movement sequences such as automated blocking of the steering axle while reversing
- ✔ Integrated TaskController data logger. As a matter of principle, every ISOBUS telemetry solution is possible (for example, TONI telemetry from CLAAS).
- ✔ Freely-configurable part-width sections



Make the most of the possibilities

Job management and documentation

All standard ISOBUS terminals from AMAZONE can collect and save machine and site-specific data using Task Controller. The collected data can subsequently be used in your Farm Management Information System.

- ✔ Easily compile or load jobs
- ✔ Processing jobs
- ✔ Document and export the work performed
- ✔ Processing of application maps in an ISO-XML format

GPS-Track

The GPS-Track parallel tracking aid makes orientation in the field much easier, particularly on grassland or in areas without tramline tracks. It has various track modes such as A-B Line and contour lines. Deviation from the ideal track is graphically shown on the display by an integrated light bar. Thanks to the clear steering recommendations with exact tramline distances you always remain on track!

- ✔ The virtual light bar in the status bar
- ✔ is standard for AmaPad 2
- ✔ and optional for the AmaTron 4

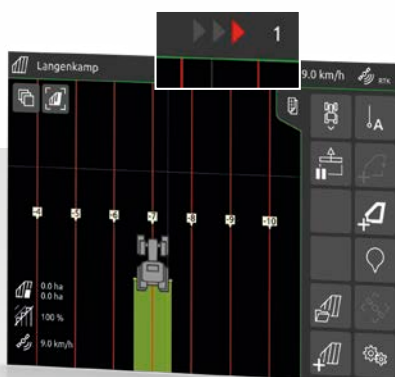

GPS-Track – your parallel driving aid in the field

GPS-Maps

GPS-Maps enables uncomplicated part-area site specific management because this software module provides easy use of application maps in a shape file format. Either the target amount of the material to be applied or the target amount of effective ingredient can be directly processed.

- ✔ Intuitive system for working from application maps
- ✔ Automatic part-area site specific regulation of the application rate
- ✔ Optimum crop management via need-oriented application
- ✔ Standard on AmaTron 4 and AmaPad 2

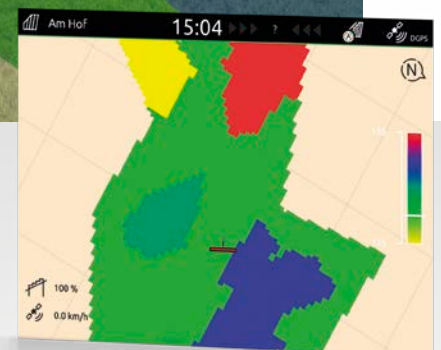

GPS-Maps – part-area, site specific application

agrirouter –

The independent data hub for agriculture



Simple and safe data exchange

agrirouter can work with products and services from different manufacturers and facilitates universal data exchange for AMAZONE. agrirouter provides a safe and easy way to exchange data between AMAZONE machines, agricultural software, manufacturers and companies.

Advantages of agrirouter:

- ✔ Simple and easy handling
- ✔ Comfortable and fast transfer
- ✔ Full control of your data
- ✔ Data are transferred, not stored
- ✔ Manufacturer-independent use

Full control – choose for yourself!

agrirouter simplifies data exchange by allowing wireless exchange of job data and application maps between AMAZONE machinery. It simplifies operating procedures, reduces administrative effort and improves profitability. You retain control of the data and decide who gets which data and to what extent.

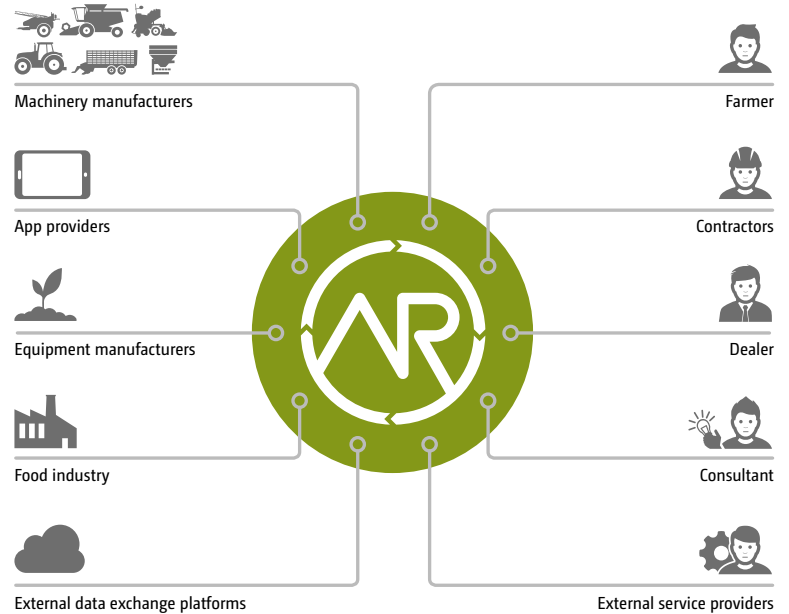

Source: DKE-Data GmbH & Co. KG



AMAZONE implements the connection to ISOBUS machines by using the AmaTron 4

Automatic GPS-Switch part-width section control with Section Control

Example: 24 m boom width (6-6-8-8-8-6-6 = 48 nozzles)

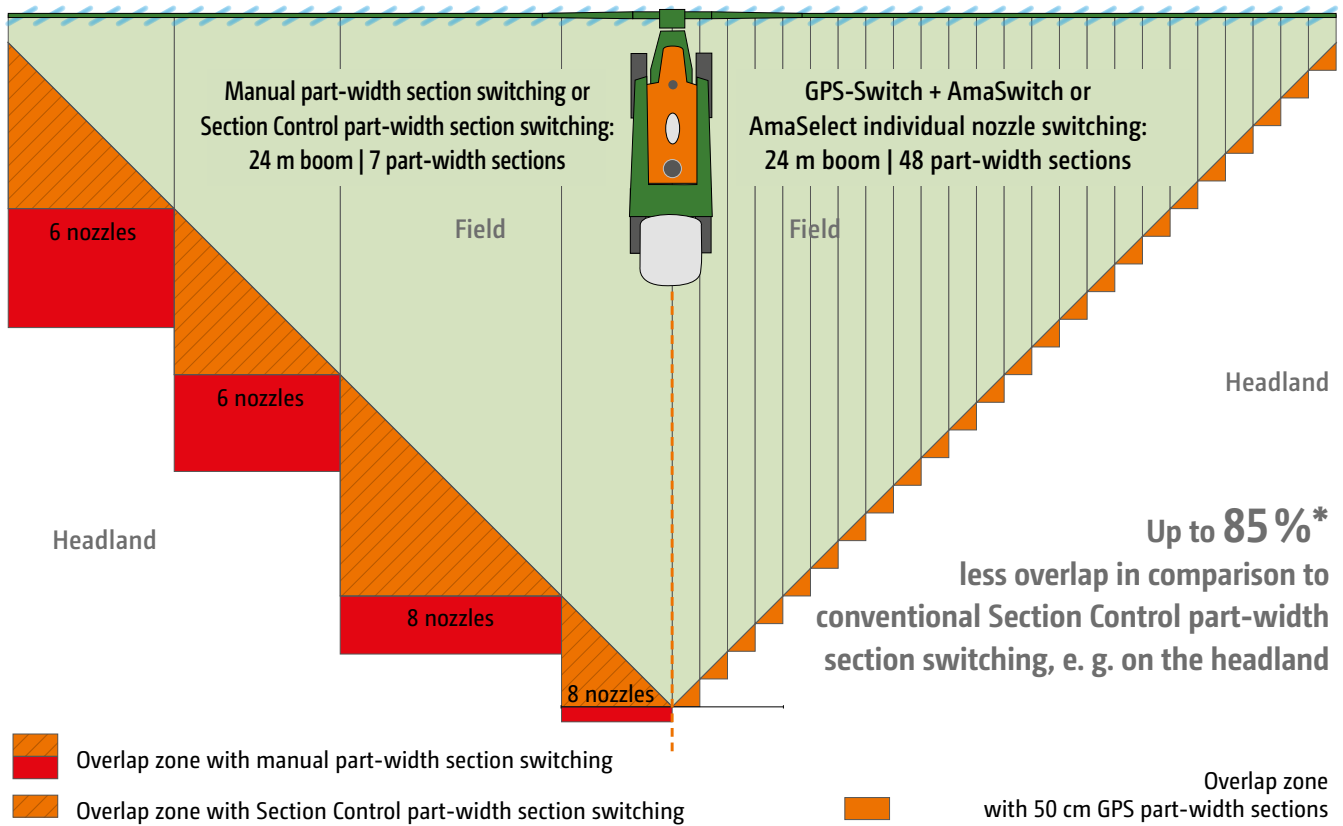

Automatic part-width shut-off for the headland and wedge-shaped fields **GPS-Switch**

5%*

Saving of crop protection agent



Electric individual nozzle switching **AmaSwitch or AmaSelect**

5%*

Additional saving of crop protection agent

* Savings are dependent on field structure, boom width and the number of part-width sections

Precise switching in 50 cm part-width sections

The decisive benefit of the individual nozzle control is the possibility to operate with small part-width sections giving an even greater degree of precision in wedge shaped fields, short work and on the headland. If AmaSwitch or AmaSelect is combined with the automatic GPS-Switch Section Control, the automatic switching of individual nozzles in 50 cm part-width sections is made possible. With this system, areas of overlap

are significantly reduced and are, in comparison with a conventional Section Control part-width section shut-off system, up to 85 % less. So, the combination of GPS-Switch and individual nozzle control results, depending on field shape and size, working width and number of part-width sections, in significant savings of spray agent compared with a normal spraying system used thus far.

Automatic part-width section control

If the terminal to be operated features Section Control, such as, for example, GPS-Switch part-width section control from AMAZONE, the switching of the part-width sections can be carried out completely automatically and in relation to the GPS position. Once a field has been established by the driver, then, in the automatic mode, they can fully concentrate on handling the vehicle whilst the switching of the part-width sections in wedges and on the headland is carried out automatically.

Benefits of automatic part-width section control:

- ✔ Stress relief on the driver
- ✔ Increase in precision especially at night or at higher speeds
- ✔ Less overlaps and gaps
- ✔ Saving of resources
- ✔ Less crop damage and environmental pollution

❗ “With Section Control, the ISOBUS computer relieves the driver from a lot of work.”

(“dlz agrar magazine” – “Test report ZA-TS fertiliser spreader”. 02/2017)

GPS-Switch

With GPS-Switch, AMAZONE offers a GPS-based, fully automatic, part-width section control for all AMAZONE operator terminals and ISOBUS compatible fertiliser spreaders, crop protection sprayers or seed drills.

GPS-Switch basic

- ✔ Automatic part-width section control of up to 16 part-width sections
- ✔ Optional for AmaTron 4

GPS-Switch pro

- ✔ Automatic part-width section control of up to 128 part-width sections
- ✔ Creation of a virtual headland
- ✔ Creation of Point of Interests (POI)
- ✔ Automated boom lowering for an AMAZONE sprayer
- ✔ Standard for AmaPad 2
- ✔ Optional for AmaTron 4

✔ AmaClick

Special crops and bed work often require the on/off switching of the individual part-width sections in the middle of the boom. AmaClick is an additional ergonomic control unit that can be used either in conjunction with the multi-function joystick or also though as a standalone system alongside an ISOBUS terminal.



ISOBUS terminals from Amazone

Intuitive, comfortable, better – workday made easy

From simple to high-tech – everything is possible

AMAZONE offers two particularly convenient operator terminals for your ISOBUS machinery in the form of the ISO-BUS-compliant AmaTron 4 and the AmaPad 2. In addition to pure machine operation, there are additional application options, such as automated GPS-Switch part-width section control.

- ✔ All applications come pre-installed and can be initially tested free of charge
- ✔ Intuitive and clear actuation

Everything in view with the 2-terminal solution

As well as operating the AMAZONE ISOBUS machine through the tractor terminal, there is also the handy alternative of separating the functionalities of the tractor and the attached machine and operating them by using two terminals. The tractor terminal can continue to control the tractor or also display the GPS applications whereas the additional operator terminal in its UT display mode is fully utilised to monitor and control the machine.



Terminal	AmaTron 4	AmaPad 2
Display	8 inch, multi-touch colour display	12.1 inch, multi-touch-colour display
Mode of operation	Touch and 12 soft keys	Touch
Interfaces	1 x Ethernet 2 x RS232 (GPS & ASD) 2x USB interfaces	1 x Ethernet 2 x RS232 (GPS & ASD) 2x USB interfaces with WLAN dongle
Job management and processing of application maps (ISO-XML and Shape)	GPS-Maps&Doc * with integrated Task Controller	Task Controller
Parallel driving aid	GPS-Track * with virtual light bar	GPS-Track pro with virtual light bar
Automatic track following	–	GPS-Track Auto for the Pantera self-propelled crop protection sprayer
Automatic part-width section control (SectionControl) Note: dependent on the max. no. of sections of the machine!	GPS-Switch basic * with up to 16 part-width sections or GPS-Switch pro * with up to 128 part width sections	GPS-Switch pro with up to 128 part width sections
Camera connectivity	1x camera connection * with AmaCam automatic reversing detection	2x camera connections *

* = optional



Everything from a single source!

Thanks to the AUX-N feature, you can operate multiple functions of the machine via AmaPilot+ or any other ISOBUS multi-function joystick.



The benefits of AmaPilot+:

- ✔ Perfect ergonomics
- ✔ Almost every function directly controlled via 3 levels
- ✔ Adjustable palm-rest
- ✔ Freely-programmable, individual key layout
- ❗ "The joystick rests comfortably in the hand."
("dlz agrar magazine" – "Test report Pantera 450Z" · 02/2016)



- ❗ "The ISOBUS control is an in-house development from AMAZONE and has been designed clearly and is easily understandable. If desired, some keys can be freely allocated. Also the multi-function display can be freely selected."
("agrarteute" magazine – "Test report Centaya seed drill" · 06/2018)

AmaTron 4

Manager 4 all



Easy and comfortable operation as intuitive as your tablet

Why not handle a terminal as intuitively like a tablet or a smartphone? With this in mind AMAZONE has developed the highly intuitive and operator-friendly AmaTron 4 which offers a noticeably smoother operational process, especially when it comes to job management. The AmaTron 4, with its 8" multi-touch colour display meets the highest expectations and offers maximum user-friendliness. A swipe of the finger or using the App carousel allows quick changes between applications and the simple and clearly structured operating menu. A useful MiniView, a freely configurable status line as well as a virtual light bar make the use of the AmaTron 4 particularly clear and convenient.

Benefits of AmaTron 4:

- ✔ Automated full image mode during non-operation
- ✔ Practical MiniView concept
- ✔ Operation via the touch display or via soft keys
- ✔ Especially intuitive and user-friendly
- ✔ Field-related documentation
- ✔ Practice-oriented and intelligent menu guidance
- ✔ Day-night mode

Standard with:

GPS-Maps&Doc



- ✔ Automated AmaCam reverse driving recognition that gives direct access to a reversing camera and prevents dangerous situations

- ✔ Machine operation (UT, Universal Terminal) in day-night mode

AmaPad 2

The especially comfortable way to control agricultural machinery



The new dimension of control and monitoring

AmaPad 2 from AMAZONE is a particularly high-quality operator terminal. The 12.1" multi-touch colour display is particularly comfortable and fulfils the highest demands on Precision Farming. The operation of AmaPad is carried out solely via touch.

With the practical "MiniView concept", applications which aren't being actively operated at that moment but need to be monitored are clearly displayed at the side. When needed these can be enlarged via "a finger swipe". The possibility to individualise a "dashboard panel" with the displays of choice rounds up the user ergonomics.

In addition to the GPS-Switch pro part-width section control, GPS-Track pro, a high-end parallel tracking aid with virtual light bar is included in the standard specification.

Benefits of AmaPad 2:

- ✔ Large 12.1" multi-touch colour display
- ✔ Extended MiniView concept
- ✔ Upgrade to automatic steering is possible thanks to the automatic GPS-Track Auto track guidance
- ✔ Day-night mode

Standard with:

GPS-Maps pro
GPS-Track pro
GPS-Switch pro



Standard equipment on the Pantera 4503

- ✔ Hydro-pneumatic suspended tandem chassis with automatic level regulation, suspension fill level and forward speed related regulated
- ✔ Infinitely-variable, automatic central track width adjustment from 1.80 m to 2.40 m (or depending on tyres up to 2.60 m)
- ✔ Hydraulic front wheel steering, all-wheel steering and dog-leg steering, forward-speed adjusted steering angles
- ✔ Headland management with automated switch from front-wheel to all-wheel steering, boom lift with AutoLift
- ✔ Speed 50 km/h, infinitely variable hydrostatic individual wheel drive with traction control
- ✔ Fill level-dependent braking system
- ✔ Deutz 6-cylinder diesel engine with country-specific 3A or 5 exhaust emission compliance; maximum power 160 KW (218 HP) according to ISO 14396, exhaust gas recirculation and diesel particle filter
- ✔ ECO-Mode: fuel saving, capacity depending engine rev regulation on the road and in the field





- ✔ CLAAS Vista cab, climate control, heating, air-suspended comfort seat, adjustable steering column, CD radio with Bluetooth hands-free mobile phone connection, sun visors for front and rear windows
- ✔ AmaDrive (Touch/10.4") colour vehicle terminal
- ✔ AmaPilot multi-function joystick⁺ for drive control and sprayer operation
- ✔ Side lights, dipped and main-beam headlights, 4-way front work lights, 4-way side work lights and 2-way side view work lights, illumination of the boom from the front as well as three work lights on the operator station and fuel tank.
- ✔ Spray pump (260 l/min pumping capacity), agitator pump (260 l/min pumping capacity), 520 l/min pump capacity in total
- ✔ Pump speed settable in the terminal and remote control of the pump via the operator terminal.
- ✔ Suction valve with 3" suction filter (32 mesh) and filling port for fresh water tank
- ✔ Pressure chest, self-cleaning 1"1/4 pressure filter (50 mesh) and part-width section control, quick emptying
- ✔ Comfort-Pack 1 for automatic filling, fill-level dependent agitation regulation and remote control cleaning from the cab
- ✔ Super-L2 boom with spray line, pendulum compensation and Profi-fold 1
- ✔ Spray agent tank 4,500 l (actual volume 4,800 l) with agitator, fill level indicator, clear water tank 500 l
- ✔ Cover for operator station, hand wash tank, external wash-down kit, digital external fill level indication



AmaProTect

The ultimate in peace of mind



Stress-free ownership

Extended warranty up to 36 months

Extended warranty

Choosing a Pantera provides you with the highest quality and reliability. You can now stay absolutely relaxed for an even longer period, thanks to the additional AmaProTect extended warranty option.

The benefits:

- ✔ Your Pantera retains its value (when maintained according to the service schedule)
- ✔ Up to 3 years' complete protection against unexpected repair costs
- ✔ Repaired with AMAZONE original spares
- ✔ Fast and flexible handling through your AMAZONE contract partner
- ✔ Long-term financial security

Fast and flexible handling

Your AMAZONE partner will support you as usual to ensure a fast solution when you need it.

They will take care of any repairs. The benefits: Repairs are carried out free of charge, so you do not have to worry.



AMAZONE Service – always in the vicinity

Your satisfaction is our challenge

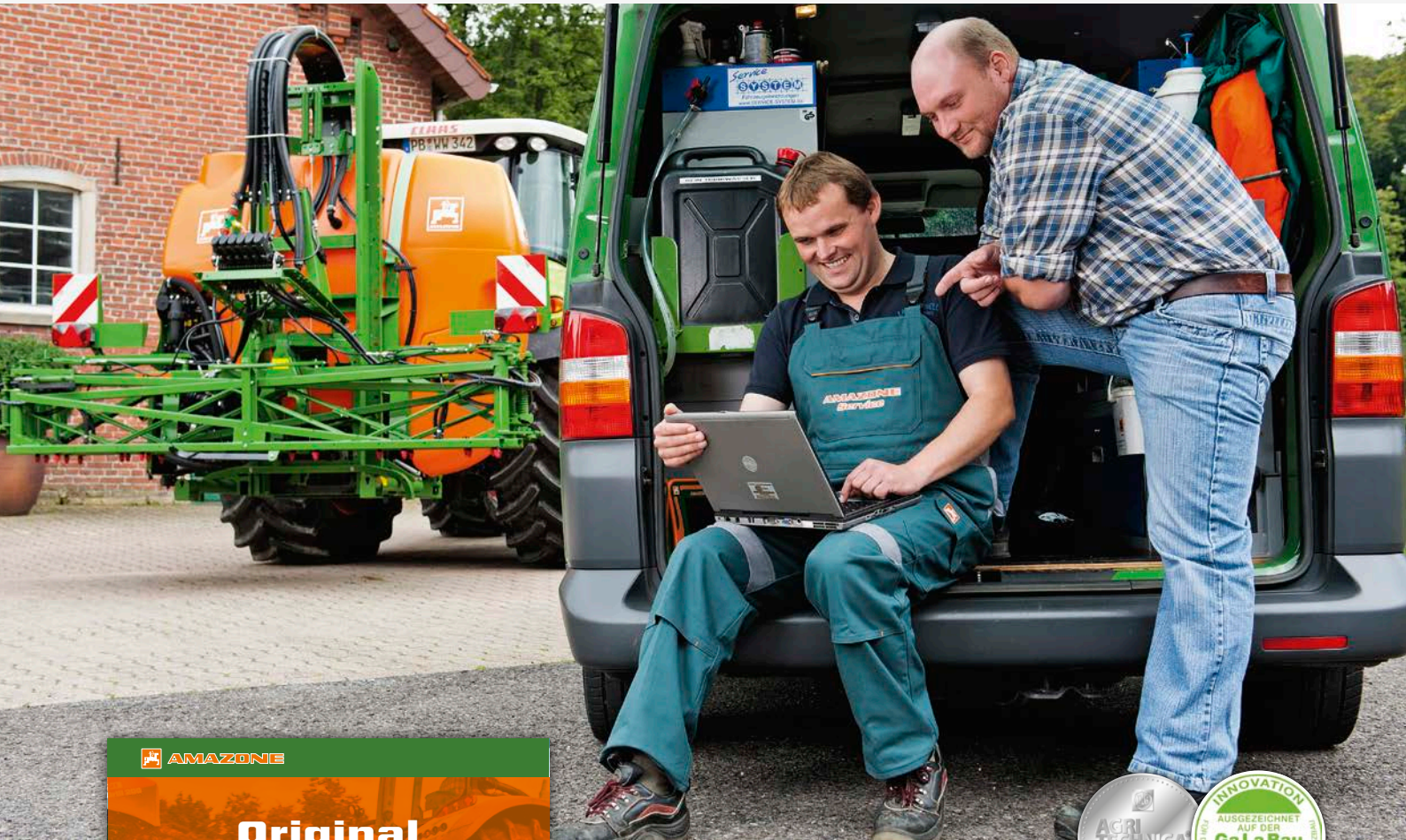

AMAZONE SmartService 4.0

Due to the increasing use of evermore complex machine technology, AMAZONE utilises, with the SmartService 4.0, both virtual and augmented reality as well as digital media for service, training and maintenance advice.

- 1 **SmartTraining:** training and instruction in the use of complex machinery by using the Virtual Reality technology (VR).
- 2 **SmartLearning:** interactive driver's training for the user for complex machinery operation (www.amazone.de).
- 3 **SmartInstruction:** repair or maintenance instructions using Augmented Reality (AR) and mobile terminal equipment
- 4 **SmartSupport:** direct local support from the service technician via Augmented Reality (AR) and mobile terminal equipment



The satisfaction of our customers is the most important objective

For this we rely on our competent sales partners. Also for service queries, they are the reliable contact for farmers and agricultural contractors. Due to continuous training, our sales partners and service technicians are always up to date when it comes to looking after this state of the art technology.

We provide you with a first-class spareparts service

Our global spare parts logistics is based at our central spare parts warehouse in Leeden. This ensures the optimum availability of spareparts, even for older machines.

Parts, are available in our central spareparts store in Leeden and which have been ordered up until 17 hours, are dispatched the same day. 40,000 different line items of spare parts and wear parts are commissioned and stored in our highly modern warehousing system. Daily, up to 800 orders are dispatched to our customers.

Better to choose the original, right from the beginning

Your equipment is exposed to the most arduous of demands. The quality of AMAZONE spareparts and wearing metal offers you the reliability and safety you need for efficient soil tillage, precise sowing, professional fertilisation and successful crop protection.

Only original spareparts and wearing metal is perfectly matched to AMAZONE machinery in their functionality and durability. This ensures the optimum operational performance. Original parts at a fair price pay off in the end.

Therefore, make your decision the original!

The advantages of original spareparts and wearing metal

- ✔ Quality and reliability
- ✔ Innovation and efficiency
- ✔ Immediate availability
- ✔ High resale value of the used machine

"SmartLearning" – the new way of driver training via a PC

Via the Internet "SmartLearning" portal, AMAZONE has extended its service offering on its homepage www.amazone.de/smartlearning with a very useful function. "SmartLearning" offers interactive driver training, which enables the driver to practice the operation of complex machinery on his own, both online and offline, via a PC or tablet. The new service offers drivers the possibility to get acquainted with a new machine prior to its initial operation. However, experienced drivers can also refresh their knowledge enabling them to utilise better still the full potential of their machinery.

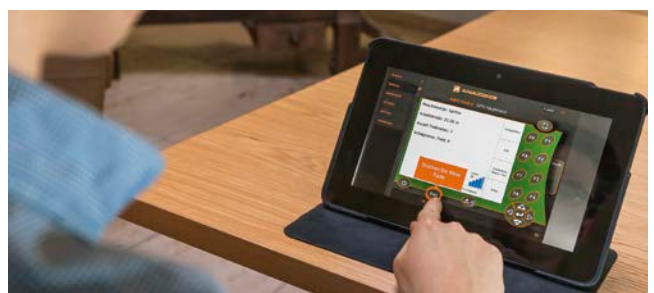



Successful for the past 50 years! Crop protection technology from AMAZONE

Tyres

Dimensions	Pantera	Pantera-W	Pantera-H	Load index	permissible load carrying capacity at 50 km/h / at a pressure of	Cross-sectional width in mm	Outer diameter in mm
300/95 R52	X	X	X	159A8 / 157B	4,200 kg/4.8 bar	310	1,890
320/90 R54	X		X	155A8 / 155B	3,875 kg/3.6 bar	319	1,948
340/85 R48	X	X		159A8 / 156D	4,200 kg/4.4 bar	345	1,805
380/90 R46	X	X	X	168D	5,600 kg/2.5 bar	389	1,842
380/90 R46	X	X	X	173D	6,500 kg/2.2 bar	383	1,842
380/90 R50	X	X	X	158A8 / 158B	4,250 kg/3.3 bar	380	1,954
380/90 R50	X	X	X	175D	6,900 kg/3.3 bar	385	1,947
480/80 R42	X	X		156A8 / 156B	4,000 kg/2.4 bar	494	1,858
480/80 R46	X		X	158A8 / 158B	4,250 kg/2.0 bar	499	1,948
480/80 R46	X	X	X	177D	7,300 kg/3.6 bar	480	1,948
520/85 R38	X	X		155A8 / 155B	3,875 kg/1.6 bar	540	1,838
520/85 R42	X	X	X	157A8 / 157B	4,125 kg/1.6 bar	516	1,951
620/70 R38	X			170A8 / 170B	6,000 kg/1.6 bar	608	1,864
650/65 R38	X			157D	4,330 kg/1.4 bar	618	1,828
710/60 R38	X			160D	4,500 kg/1.0 bar	712	1,814

Illustrations, content and technical data are not binding! Deviations of technical data are possible depending on the equipment. The illustrations may deviate from the requirements for local road traffic regulations.

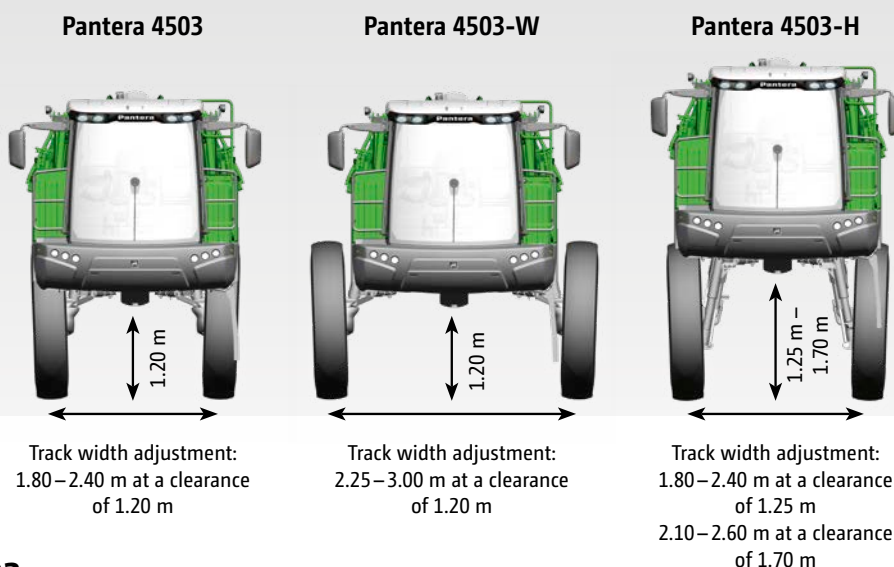

Technical data: Pantera 4503

Model	Pantera 4503	Pantera 4503-W	Pantera 4503-H
Nominal volume (l)	4,500		
Actual volume (l)	4,800		
Fresh water rinse tank (l)	500		
Working width (m)	21 – 40		
Fuel tank capacity (l)	230		
DEF tank (l)	20		
Max. working speed (km/h)	20		
Transport speed (km/h)	up to 50		
Length (m) (Transport position, plus external wash down kit)	8.60		
Transport width (m)	2.55	2.75	2.55
Spraying height min./max. (m)	0.50 – 2.50 with lift module 0.50 – 3.20		0.50 – 3.00 with lift module 0.50 – 3.70
No. of part-width sections (min./max.)	7 – 13		
No. of sections with individual nozzle switching: Amaswitch or AmaSelect	up to 80		
Unladen weight (kg)	9,600	9,950	10,500
Max. total weight (kg)	15.800 (depending on tyres)		
Delivery capacity pump (l/min)	520		
Turning circle, all-wheel steer (m)	4.50		
Track width (m)	1.80 – 2.40	2.25 – 3.00	1.80 – 2.40 at 1.25 2.10 – 2.60 at 1.70
Ground clearance (m)	1.20	1.20	1.25 / 1.70 in the lower/upper working position
Engine power	max. 160 kW (218 HP) (Data according to ISO TR 14396)		

Illustrations, content and technical data are not binding! Deviations of technical data are possible depending on the equipment. The illustrations may deviate from the requirements for local road traffic regulations.



AMAZONE



AMAZONEN-WERKE H. Dreyer GmbH & Co. KG

P. O. Box 51 · D-49202 Hasbergen-Gaste/Germany

Phone: +49 (0)5405 501-0 · Fax: +49 (0)5405 501-193