



Baler-wrapper combinations
i-BIO+, FBP, VBP





Summary

- | | | |
|---|--|---|
| 04 The KUHN bale | 18 Excellent wrapping | 32 Overview VBP 3165 - 3195 |
| 06 Choose your baler | 20 KUHN ISOBUS solutions | 34 The ultimate in power and versatility |
| 08 Intake performance | 21 PROCESS VIEW | 36 Overview VBP 7160 - 7190 |
| 10 Clever solutions that keep you going | 22 The i-BIO+ concept: clever and compact | 38 Benefit from more equipment |
| 12 Perfectly shaped bales, high-quality forage | 24 Overview i-BIO+ | 40 Customers speak out... |
| 13 Net binding | 26 High-quality bales at the lowest costs | 41 KUHN Premium packaging products |
| 14 Preserve your valuable crops | 28 Overview FBP 3135 | 43 Technical specifications |
| 16 TWIN-reel film binding | 30 Versatility and flexibility | |

i-BIO+ | FBP | VBP

Baler-wrapper combinations

MAXIMISE YOUR SILAGE QUALITY AT THE LOWEST COSTS

KUHN ROUND BALER-WRAPPER COMBINATIONS ARE DESIGNED TO MAXIMISE YOUR SILAGE QUALITY AND YOUR RETURN ON INVESTMENT. WE OFFER A WIDE RANGE TO MATCH YOUR INDIVIDUAL PREFERENCES, PERFECTLY ADAPTED TO YOUR CIRCUMSTANCES AND ALL DEVELOPED WITH THE LATEST PRODUCT INNOVATIONS.



PERFECT BALE SHAPE AND DENSITY

Perfectly shaped, consistent round bales are the end-result what every customer is looking for. With over 35 years of experience in baling and wrapping, our machines can produce high bale densities even in the most demanding conditions.

CAPACITY

Our goal is to develop machines that boost the profitability of your company. High output is a key success factor for every baler. KUHN baler-wrapper combinations feature several unique points that deliver this capacity to your company.

RELIABILITY

To achieve a maximum efficiency of your machine, an unmatched reliability is a must. KUHN offers the most efficient and versatile range of balers and wrappers available on the market designed with simple, but efficient techniques. This results in a minimum downtime and a machine that you can trust.

THE KUHN BALE

As an agricultural professional you only want the perfect bale. KUHN offers quality machinery and innovative technologies to produce this bale. The KUHN bale. Easily recognisable by the following aspects:

PERFECT BALE SHAPE

Well-shaped bales provides much more than just aesthetic appeal. With KUHN combi balers you produce consistently perfect round bales which are easy to stack and handle. Combine the unique film binding and 3D wrapping systems for even more tightly packed, barrel-shaped bales.

FORM STABILITY

KUHN bales retain their round shape, even after long storage periods. It prevents the bale from collapsing or the film from shifting. This keeps your crops preserved for a long time.

WELL-PRESERVED FORAGE QUALITY

Your crops are one of your most valuable assets. In a KUHN bale they are well looked after. Throughout the entire process, from baling to storage, air is minimised. Less air means a reduction in the risk of mould and a better preservation, therefore, higher forage quality as a result.

LOW COSTS PER BALE

Did you know KUHN combi balers produce extremely well preserved bales at a low cost? This is due to the patented* TWIN-reel film binding system that uses regular film rolls. Next, with INTELLIWRAP you can determine exactly what your bale needs with one layer more or less.

HIGHEST BALE DENSITY

KUHN bales' density stands out. Whether you are baling hay or silage crops, you can expect a very firm bale. Smart solutions like the patented* i-DENSE system on the VBP 7100 series take bale density to the highest level on the market.

THE CONTRACTOR'S SHOWPIECE

The need for high quality feed with a low cost is becoming increasingly more important. Producing KUHN bales is where you as a contractor can make a valuable difference. And, after a long day of work, isn't it great to see a field full of beautiful, tightly wrapped bales?



CHOOSE YOUR BALER



Are you a farmer or a contractor? Do you produce many or few bales? Are you looking for maximum versatility or do you prefer an expert in a particular crop or condition? KUHN is the Baler-Wrapper specialist. With the widest range in the market we always have the right machine for every situation. Our field specialists are there to find the best solution together with you.



i-BIO+: Clever and compact

Perfectly suited to hilly conditions and use on small or wet fields with narrow access gates.

- Lightweight; only from 3700 kg
- Ultra compact design due to the integrated wrapper
- Low power requirement



FBP 3135: High-quality bales at the lowest costs

Thanks to its robust design and unique options, this machine can boost your business' profitability.

- 18 POWERTRACK rollers bale chamber for exceptional high densities and a long service life, even in the heaviest crop conditions
- Unique patented* TWIN-reel film binding system
- Operator comfort and maximum control guaranteed by PROCESS VIEW user interface



VBP 3100 series: Versatility and flexibility

Extreme versatility and flexibility all year round in terms of bale size and machine usage.

- Proven bale chamber design provides the best results in a very broad range of crops and conditions
- Unique patented* TWIN-reel film binding system
- INTELLIWRAP for optimal film use



VBP 7100 series: The ultimate in power and versatility

The new league of combi balers; for the most demanding user down to the last detail.

- Unique bale chamber design for unrivalled bale density and versatility
- Unrestricted intake and fastest bale transfer
- Unique patented* TWIN-reel film binding system

INTAKE PERFORMANCE

KUHN balers guarantee optimal crop intake. The wide cam-track pick-up unit provides maximum ground adaption when combined with its pendulum capabilities, enabling it to work in the toughest conditions. All KUHN baler-wrapper combinations are equipped with our proven INTEGRAL ROTOR technology.



HARDOX®
WEAR PLATE

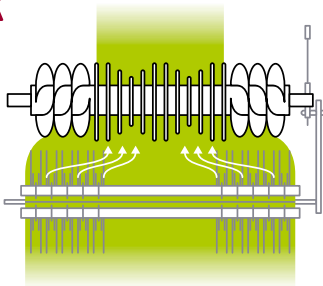

EXCLUSIVE

INTEGRAL ROTOR

This simple, maintenance-free INTEGRAL ROTOR intake system guarantees an enormous throughput capacity at all times. The short distance between rotor and pick-up tines maintains consistent crop flow. The design of this force-fed intake makes higher forward speeds possible for increased productivity and reduced crop damage. The INTEGRAL ROTOR has rotor tines made out of Hardox® wear plates. Hardox® combines extreme hardness and toughness to reduce rotor tine wear.

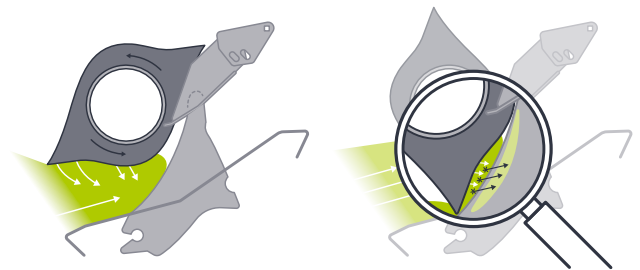

PATENTED

Patented rotor tine shape

KUHN OPTICUT (OC) cutting rotors are designed for unlimited intake capacity and excellent cutting quality. OC cutting rotors, with patented* elliptical-shaped rotor tines, are acknowledged by users as one of the best cutting systems on the market. The silage is guided and drawn down to the knives from an early stage which improves flow and cutting performance while requiring minimal force - this also prevents unwanted blockages.

*Patent or patent pending in one or more countries.



OPTICUT 14 knives (OC 14)

The INTEGRAL ROTOR, with the 14-knife OPTICUT system, is designed to even out the swath and force-feed the crop into the baler for maximum throughput. The 14-knife OPTICUT cutting system provides a theoretical cutting length of 70 mm. Each single knife is spring-protected against damage from foreign objects. With GROUP SELECTION, the operator can choose to have 0, 4, 7, 7 or 14 knives in operation.



OPTICUT 23 knives (OC 23)

The INTEGRAL ROTOR, with the 23-knife OPTICUT system, has the benefits of intensive cutting and mechanical protection. The 23-knife OPTICUT system provides a theoretical cutting length of 45 mm. Each single knife is spring-protected against damage from foreign objects. With GROUP SELECTION, the operator can choose to have 0, 7, 11, 12, or 23 knives in operation.

Shown rotor pictures represent the i-BIO+, FBP and VBP 3100 series. For the VBP 7100 series, see page 36.

CLEVER SOLUTIONS THAT KEEP YOU GOING

During tight harvest windows, you want to keep going. KUHN developed clever solutions to prevent crop blockages or, if they do occur, quickly solve them. So that you can resume your baling operation as soon as possible. Boosting your efficiency and improving operator comfort.





DROPFLOOR

The floor and knives can be hydraulically lowered from the comfort of the tractor cab in the case of a rotor blockage. After the blockage is cleared, they can easily be brought back into work position.



Rotor disengagement

In extreme circumstances, double security is provided by a standard rotor disengagement clutch. This will enable the operator to bind and eject the bale from the chamber before continuing. Both the rotor disengagement and DROPFLOOR technology ensure a fast clearance in case of a blockage and enables you to quickly continue your baling operation. The rotor disengagement is manually operated on the i-BIO+ and VBP, on the FBP a hydraulically operated rotor disengagement comes as standard.

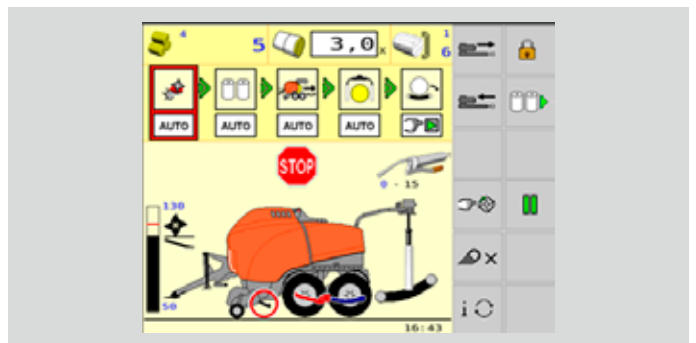

Fully automatic rotor deblock system

The baler's overload protection clutch activates whenever the baler's intake gets obstructed by the amount of crop to be fed in. The DROPFLOOR automatically lowers and the knives are retracted. The operator is informed about the ongoing process via the terminal. After the PTO is re-engaged, the rotor restarts and the crop is guided unobstructed into the bale chamber, the DROPFLOOR and knives automatically return to their position.

PERFECTLY SHAPED BALES, HIGH-QUALITY FORAGE

KUHN bales stand out in bale density and shape. After the bale has left the bale chamber, it is important to keep it that way. KUHN's binding techniques offer maximal holding force and optimal bale shape retention. All baler-wrapper combinations are equipped with the Net binding system as standard, Net + Film binding is optional.



BINDING SYSTEMS	i-BIO+	FBP 3135	VBP 3165/3195	VBP 7160/7190
NET BINDING SYSTEM	◆	◆	◆	◆
NET + FILM BINDING SYSTEM	◇	◇	◇	◇



Net binding

Net binding is the better option for dry crops such as hay and straw. The bale can breathe better because there is no film sealing around it. The innovative Net binding system with active stretch technology can be found on all KUHN baler-wrapper combinations.



PATENTED

Net + Film binding

For silage conditions, the KUHN Net + Film binding system is the better option. When binding the bale with film the extra layers of film around the bale seal the crop in an airtight manner, thus ensuring better preservation and form stability. In addition, film binding offers several efficiency benefits.

NET BINDING



INNOVATIVE

Constant net tension

The net binder with active stretch technology ensures a firm bale shape with constant high net tension throughout the entire binding cycle. The net is fed into the front of the bale chamber to ensure it is taken by the bale immediately. KUHN's innovative design maintains constant net tension during the binding process. The net wrap system runs at a lower speed than the bale's rotational speed to be able to consistently stretch the net up to 10% without breaking it. The pre-stretched net results in a bale that will hold its density.

Optimal air exclusion

The net binding system spreads the net to the corners of the bale to prevent air pockets once the bale is wrapped, which will preserve the forage quality for longer.

PRESERVE YOUR VALUABLE CROPS

Binding a bale with film improves the bale shape and the forage quality. Multiple film layers improve the quality of sealing and limit the development of mould in the bale. Using film for both binding and wrapping offers the additional advantage of having only one type of waste material and the bale is much easier to unwrap.



Maximise your forage quality

A recent study* showed that crop preservation is significantly better with film bound bales than with net bound bales. The film-only wrapped bales showed increased fermentation and reduced DM losses because there was less oxygen enclosed in the bale. Resulting in more nutritional value retention and thus higher quality forage.



Improved storage characteristics

Not only are bales which are deformed more critical to handle, also the stress on the film could decrease the feed value of the crop. Film binding of bales helps to increase the bale shape and stability during longer storage periods. Thanks to the stretch-type film, force is applied to the cylindrical side of the bale. This ensures that the cylindrical characteristics of the bale are further increased.



Fast and easy film removal

The film can be removed fast and easily from the bale, as it will not be tangled up in the crop. Especially in sub-zero temperatures this can be a huge time-saver for your daily feed operation. Besides, there will be less loss of silage.



Easy recycling

When it comes to waste management, film-only bales provide additional time savings and costs. Only one type of material is used so there is only need for one recycling process to be put in place just for the film wrap.

TWIN-REEL FILM BINDING

The highest silage quality at the lowest costs. KUHN's patented* TWIN-reel film binding allows you to benefit from all the advantages of film binding while significantly reducing your film costs. The crucial point is the use of two regular stretch-film rolls instead of special wide mantle film. TWIN-reel film binding is available on all i-BIO+, FBP and VBP models.



PATENTED

Save a minimum of 37% on your film binding costs

The KUHN patented* film binding system uses two regular 750 mm stretch-film rolls. Using regular wrapping film enables you to use a much higher pre-stretch ratio compared to conventional wide film binding systems. This reduces your film binding costs by 37% and extends the film change intervals by another 30%.

One type of film for binding and wrapping

The KUHN binding system uses the same film rolls as used for wrapping. This eliminates the need for special wide mantle film, which simplifies your inventory management.

Easy exchange of film rolls

Thanks to the limited weight per roll (not more than 27 kg), the rolls are easy to handle. This, combined with the low lifting height and the user-friendly film roll system, makes the exchange of film rolls an easy job.

1. Fold out the film roll
2. Slide off the empty film roll and replace it with a new one
3. Repeat steps 1 and 2 in reverse order
4. Fold in and insert film in binding system

You can easily switch between film and net and vice versa without taking the net and film rolls out of the machine.



KUHN film binding explained

What makes the KUHN TWIN-reel film binding system unique? Watch the video and find out!



Guaranteed binding start

The starting string of the film ensures secure binding and a reliable start-up in all circumstances, resulting in minimum downtime. Regardless of rain or hilly terrain, the binding will start. The two strings of film ensure the binding material is applied on top of the bale. It is not necessary to feed some extra material in the chamber at this point. From being pulled in as a string, the film quickly reaches the full width of the bale. Another film saving compared to a conventional wide mantle film system!



Adapted bale chamber

The VBP and FBP feature a specially adapted bale chamber to prevent film damage and to guarantee film binding without any compromises. The loading arms are equipped with special smooth rollers to prevent damage to the film during the bale transfer.



Easy switching between net and film binding

The film and net binding systems are two separate systems, which enable the operator to carry both film and net at the same time. Switching between the two is quick and easy – you don't have to change rolls and there are no tools needed.

EXCELLENT WRAPPING

The key to achieving the highest forage quality is an optimal and intelligent wrapping process. KUHN's leading wrapping innovations offer the tools to maximise the preservation quality and 'seal your profit'.

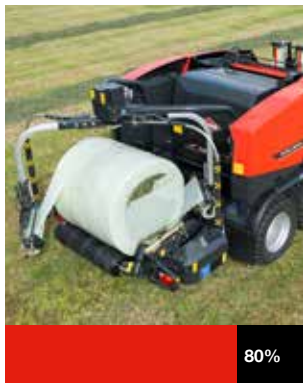
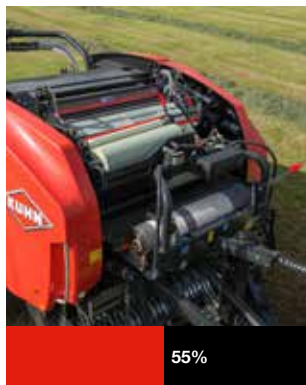

EXCLUSIVE

3D wrapping

KUHN's 3D wrapping is an intelligent and innovative way of applying stretch film to round bales. It distributes the total film quantity more uniformly and efficiently across the entire surface of the bale. 3D wrapping will first apply the film where it is most needed: the vulnerable bale shoulders. The cylindrical wrap ensures that more air is excluded and that the bale retains its shape, even after long storage periods.

Our recommendation:

Film binding, 3D wrapping and INTELLIWRAP combined

Use of KUHN's 3D wrapping and film binding systems provides well-shaped, tightly sealed bales that will maintain silage quality over long storage periods. Beside the improved bale shape, 3D wrapping helps protecting the most vulnerable part of a bale: the shoulders. Add the INTELLIWRAP technology and you are able to determine the required number of film layers exactly. And that pays off!

KUHN Wrapping technologies explained

What are the advantages of INTELLIWRAP and 3D wrapping? Watch the videos and find out!



INTELLIWRAP



3D wrapping

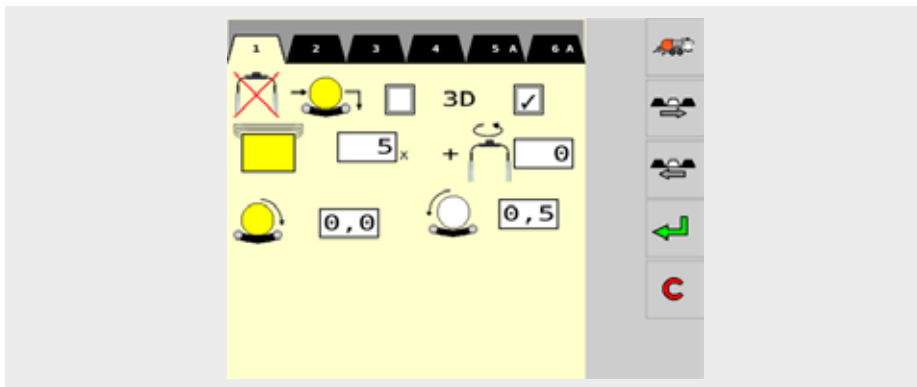

Selection of 5 film layers

EXCLUSIVE

INTELLIWRAP

For good preservation, the number of layers of wrapping film is very important. It should be adapted to the humidity of the crop and the desired storage time. With standard wrapping systems, you can only wrap an even number of layers. But sometimes you need an odd number. With the unique INTELLIWRAP technology you can determine exactly what your bale needs with one layer more or less (4, 5, 6, 7, 8, 9...). You don't waste film and you use just enough to keep feed quality high during bale storage.

Film cutters

KUHN film cutters offer reliability in every condition. They are famous for their quick bundling and clean cutting of the film, together with a guaranteed holding and releasing of the film at the start of the next wrapping cycle.

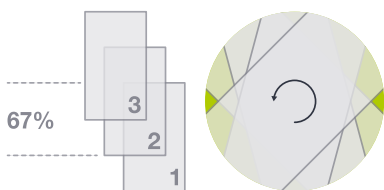

The bale is covered with 3 layers and 67% overlap

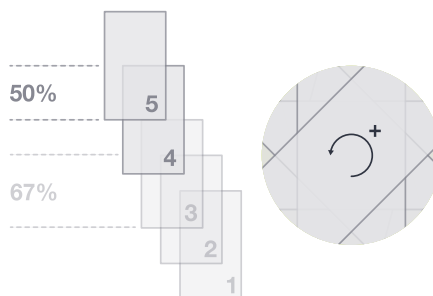

Increasing of the bale rotation speed and final 2 layers with 50% overlap

KUHN ISOBUS SOLUTIONS: TAKE ADVANTAGE OF ISOBUS COMPATIBILITY ON THE BALER-WRAPPER COMBINATIONS!



VTI 60, CCI 800 AND CCI 1200: A SINGLE TERMINAL FOR ALL KUHN MACHINES.
VTI 60, CCI 800 and 1200 ISOBUS terminals are AEF-certified. They focus on three priorities: performance, visibility and flexibility. The VTI 60 is distinguished by its simplicity and user-friendly backlit keys. The CCI 800 and 1200 are equipped with a large size antiglare touchscreen. Capable of displaying simultaneously different essential information and accepting the connection of a camera, these terminals offer a high level of flexibility.



VTI 60: The perfect size to control your ISOBUS machine

The new VTI 60 ISOBUS terminal has a 5.7"/14.5 cm display. Its 12 backlit keys allow quick operation of the machine's functions. The colour touch screen makes it easy to enter parameters and access the various menu pages.



CCI 800: The compact ISOBUS terminal

The 8"/20.3 cm screen displays the main machine and miniviews on the side. Click on one of the mini-views to switch it to the main screen.



CCI 1200: innovative, large-size, high-performance

With the 12.1"/30.5 cm screen, all essential information is displayed. Several display layouts are available: miniview / maxiview / double UT.

A MULTITUDE OF APPLICATIONS AS STANDARD



TECU

Retrieve the tractor's basic information



CONTROL

Control your tasks and ISO-XML documentation



CONVERT

Connect to your biomass sensor



CAMERA

Connect a camera and display live pictures



HELP SYSTEM

The help you need

DISCOVER THE CCI APPLICATIONS



DATA TRANSFER

Data import/export via Agrirouter



PROCESS VIEW

Thanks to the PROCESS VIEW user interface, the FBP and VBP feel very easy to use. You are always informed about the current status of your work processes. The user interface displayed on the ISOBUS terminals allows you to choose which process is executed automatically or manually, and all processes can be paused at any time.

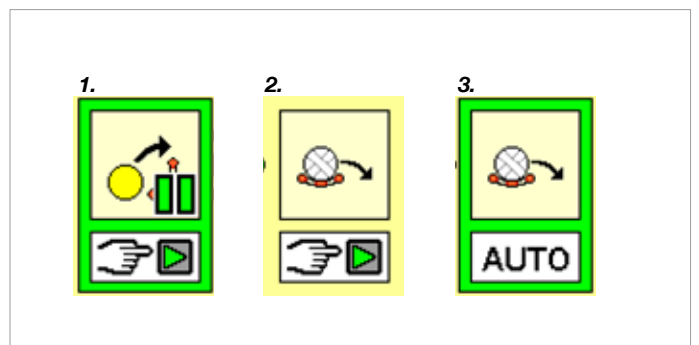
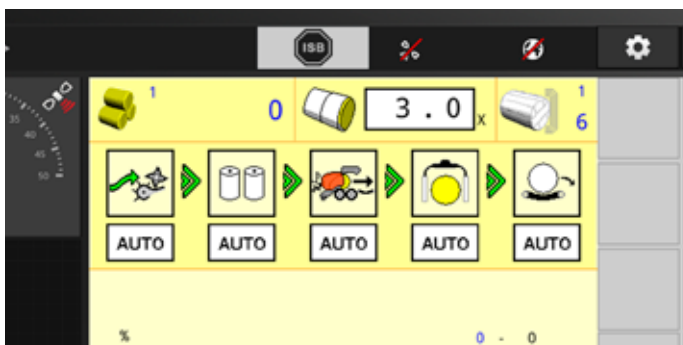

EXCLUSIVE

Processes

All processes are displayed on the ISOBUS terminal. As an example, the VBP and FBP show the intake (AUTO DEBLOCK) and the binding as separate processes. When the process is marked green, it is executed. When the process is marked red, an issue occurred and the operator is informed acoustically and visually.

Full control

With just a tap of your finger, you are able to pause a process [1], or choose between manual [2] or automatic [3] operation. This intuitive approach ensures that all operators can work with the machine, and you can benefit from added productivity.

i-BIO+

THE I-BIO+ CONCEPT: CLEVER AND COMPACT

The unique Bale-In-One concept, where the crop is baled and wrapped in the same place, is the basis of this ultra-compact, easy to maneuver and lightweight machine. A combi baler that fits like a glove in hilly conditions and in small or wet fields. But it is also being discovered by more and more farmers operating in normal conditions as a baler-wrapper combination with a good price-performance ratio. For more than two decades already, this proven concept has been offering farmers and contractors all around the world high-quality bales, and will continue to do so.

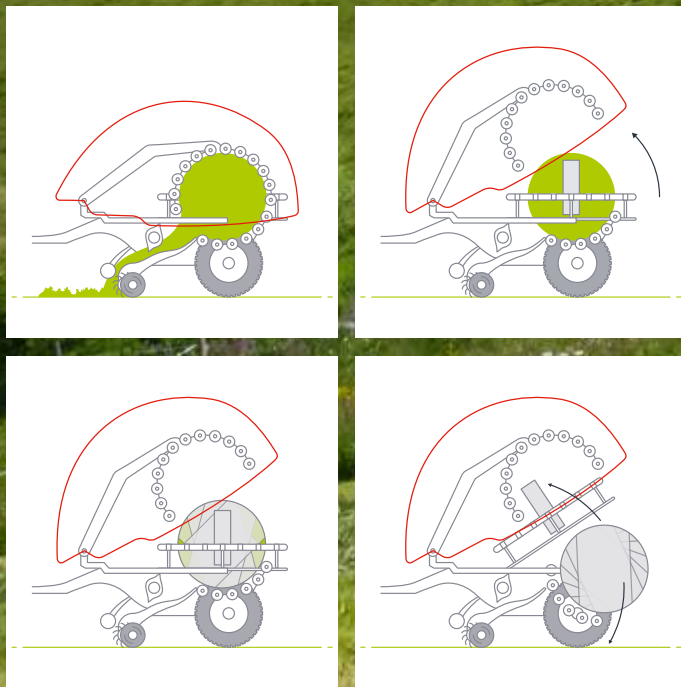

INNOVATIVE

Lightweight and manoeuvrable

Thanks to the unique design of the i-BIO+, with an integrated wrapper, two operations are combined in one machine. This highly compact and lightweight machine weighs only 3700 kg. With its low weight and excellent manoeuvrability the KUHN i-BIO+ offers you outstanding performances in hilly conditions and in small or wet fields with narrow access gates.

Bale formation

For compressing the crop into consistent size and dense bales, the baling process has to be as effective as possible, while being gentle on the crop. The bale chamber of the i-BIO+ consists of 18 rollers with POWERTRACK profile for reliable bale rotation. 6 rollers in the bottom chamber segment create an ideal wrapping table which is film-friendly. The integrated stainless steel low-friction plates offer a significant reduction of the power requirements.



INNOVATIVE

High-speed and intelligent wrapping

The bale is ready for immediate wrapping after the upper part of the bale chamber is raised. No bale transfer is needed. The bottom part of the bale chamber is now functioning as the wrapping table. The wrapping ring is unique to the i-BIO+, with two integrated pre-stretchers. They rotate close around the bale with outstanding speeds (of up to 50 rpm). It only takes 18 seconds to wrap a bale with 6 layers of film.

Pivotable pre-stretcher ring

Operator comfort in every detail. The pre-stretcher pivots over the wrapper ring in order to easily exchange the film rolls. The integrated support roll prevents damage of the film and helps supporting the weight which means you can exchange the film rolls effortlessly.

OVERVIEW



1. Robust driveline with high-quality IWIS chains

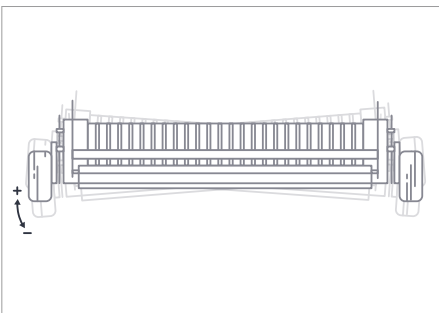

2. Pendulum pick-up

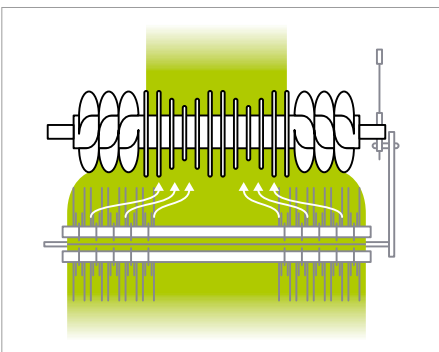

3. INTEGRAL ROTOR Technology



4. Mechanical rotor disengagement





OPTIONS



500/45-22.5

560/45R22.5



650/40R22.5



BEKA-MAX automatic bearing greasing system



TWIN-reel film binding



Bale turner



Several hitch options including a ball-hitch coupling



Bale stopper

HIGH-QUALITY BALES AT THE LOWEST COSTS

The FBP 3135 brings together all features to create the highest bale quality at the lowest costs: the perfect bale. A high quality is achieved as a result of film binding and 3D wrapping techniques. A lowered cost thanks to the robust design resulting in low maintenance costs, a low power consumption thanks to the patented* rotor tine shape. Moreover, TWIN-reel film binding and INTELLIWRAP contribute to the lowest film cost per bale.



Bale shape and density

Key ingredients for the perfect bale are an optimal bale shape and high densities. The combination of the INTEGRAL ROTOR and unique bale chamber design results in a perfect bale shape with optimal filling of the bale from shoulder to shoulder. The crop is distributed evenly over the full width of the bale and the hydraulic tailgate pressure system, resulting in the highest bale densities. Producing dense bales means excluding as much air as possible from the bale, therefore achieving an optimal preservation quality.



Robust bale chamber

The heart of the baler consists of 18 POWERTRACK rollers which generate exceptionally high densities and reliable bale rotation in all crop conditions. Thanks to the 50 mm double raced bearings on the drive side main load points, trouble-free baling in heavy conditions is guaranteed. All bearings are connected to the central BEKA-MAX automatic bearing greasing system. The rollers have built-in scrapers to push the material out and away from the bearings.



Easy and intuitive operation

The robust design and a combination of the INTEGRAL ROTOR and 18-roller bale chamber allows all users, from experienced to starter, to create perfectly shaped bales. The PROCESS VIEW software is easy to understand and intuitive to operate; all steps of the baling and wrapping process can be set in an automatic modus to create maximal operator comfort.

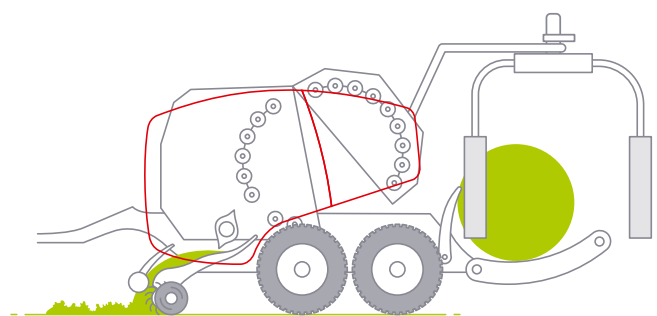

Fast and reliable bale transfer

To minimise idle time and maximise output, a rapid bale transfer is required. The side guide protection plates ensure a rapid and secure bale transfer even when working in steep or sloping fields. The 4-belt wrapping table with 2 large rollers and 4 side cones provide maximum bale traction, even bale rotation and proper film overlap, regardless of the bale shape. The improved 'twin loading arm' system offers a faster bale transfer of up to 30%.

OVERVIEW



1. Robust driveline with high-quality IWIS chains

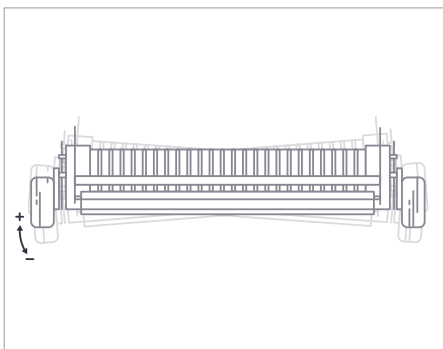

2. Pendulum pick-up

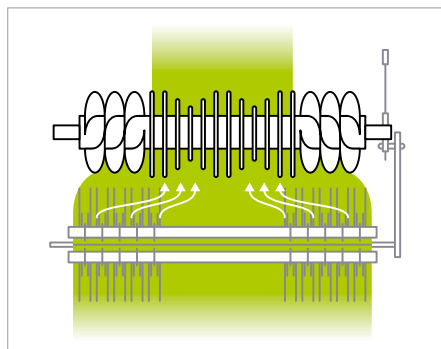

3. INTEGRAL ROTOR Technology



4. Standard hydraulic rotor disengagement



OPTIONS



Weighing system



3D wrapping



TWIN-reel film binding



Pivoting semi-pneumatic pick-up guide wheels



4 kg grease pot



Bale turner



5. Standard automatic greasing system for roller bearings



6. BEKA-MAX continuous chain oiling system

VBP 3165-3195

VERSATILITY AND FLEXIBILITY

VBP 3100 series variable chamber combi balers offer extreme versatility and flexibility. Not only the bale size is variable but the machine usage is too. Whether you harvest straw, hay or silage, one machine will do the job. With their unique bale chamber design VBP 3100 balers provide the best results in a very broad range of crops. Equipped with the optional KUHN TWIN-reel film binding system, the machine becomes even more versatile in silage conditions.



EXCLUSIVE

PROGRESSIVE DENSITY

The PROGRESSIVE DENSITY system has proven its value on all KUHN VBP balers. The system increases tension as the bale grows providing a firm bale with a tough outer shell.

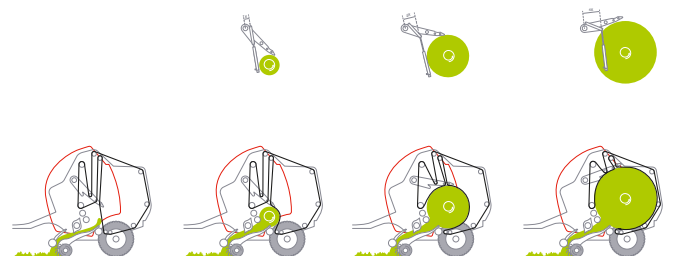

How does it work?

As the bale grows within the bale chamber, the belt tensioning arm is subjected to steadily increasing resistance from two hydraulic cylinders and a spring tensioner. So as the diameter increases, the bale's density does too. The result is a very firm bale with a moderate core – not too soft, not too hard. With a tougher outer layer, straw bales will be more tolerant to bad weather conditions, while silage bales will maintain their shape for improved stacking and easier handling.

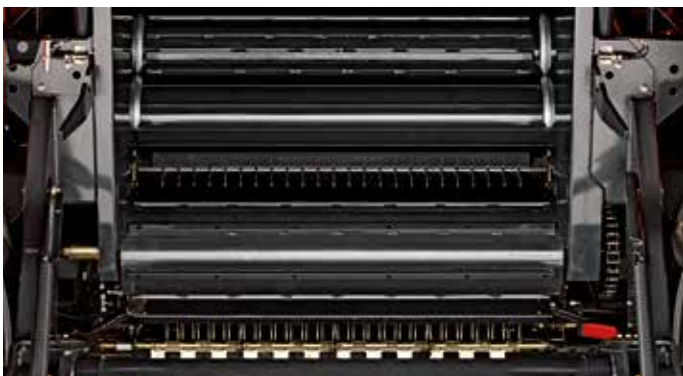

Fast, perfect bale formation

The 5 belt, 3 roller design of the bale chamber ensures fast, consistent bale formation whatever the intake system. The aggressive profile of the top chamber roller improves crop contact and reduces crop loss. The front segment of the baler is fitted with a large smooth roller and driven cleaning roller that prevents crop build up at the front of the machine. The unique mix of the KUHN PROGRESSIVE DENSITY system and smart bale chamber design guarantees perfect bale formation every time.

Versatility in all its aspects

Producing small diameter hay bales for easy handling in horse stables, versus large diameter silage bales to use the crop packaging material as efficiently as possible. Bale silage in the morning, switch to straw in the afternoon, and finish with hay. The investment in a multidisciplinary machine on your farm eliminates the need for separate machines. Imagine the possibilities!

OVERVIEW



1. Second belt driven roller guarantees a secure belt drive in all crop conditions

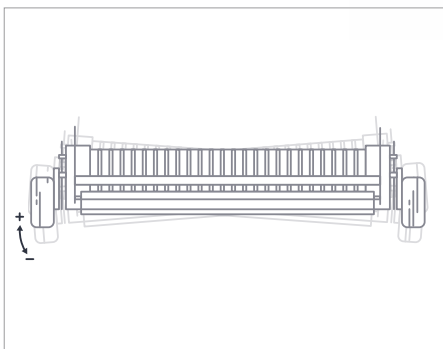

2. Pendulum pick-up

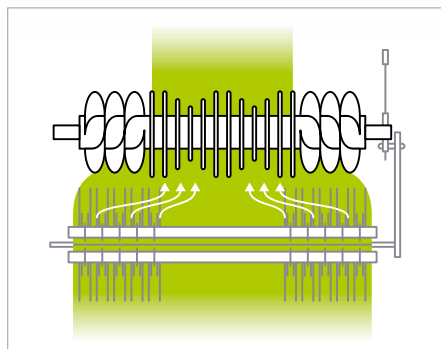

3. INTEGRAL ROTOR Technology



4. Heavy crop roller with a windguard (Ø 217 mm)



5. BEKA-MAX continuous chain oiling system



6. Clean & straightforward design consisting of robust components

OPTIONS



Weighing system



Moisture system



3D wrapping



TWIN-reel film binding



Pivoting semi-pneumatic pick-up guide wheels



Bale turner

VBP 7160-7190

THE ULTIMATE IN POWER AND VERSATILITY



Extreme versatility and density

The VBP 7100 series stand out with their great versatility and performance in various conditions. These baler-wrapper combinations produce straw bales with the highest density on the market. But they can also handle short wet silage crops in autumn conditions, all thanks to the patented* i-DENSE density regulation system which ensures an optimal bale start and baling pressure. The intake system with up to 23 knives enables a wide range of cutting lengths. Equipped with the optional KUHN TWIN-reel film binding system, the machine becomes even more versatile in silage conditions.

34 *Patent or patent pending in one or several countries.

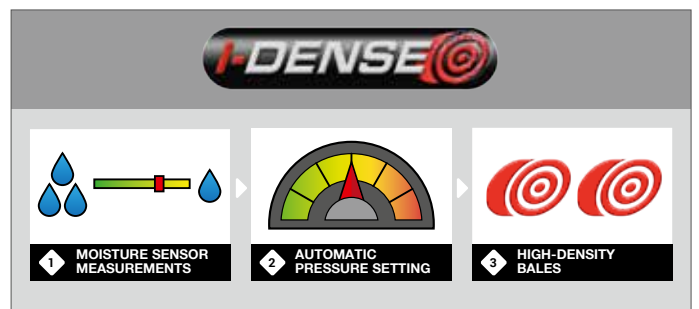

PATENTED

i-DENSE system

The patented* i-DENSE system automatically adapts the baling pressure according to the different crops and crop conditions, without the interference of the driver. The system consists of a moisture sensor combined with an intelligent twin-tension arm system for optimal tension distribution. Resulting in the most economical use of your baler without compromising on performance.



Welcome to a new league of combi balers! Discover the VBP 7100 series variable baler-wrapper combinations, the most powerful and versatile machines you have ever experienced. The durable, heavy-duty construction ensures maximum capacity, from intake to wrapping. Rely on a constant high performance in all circumstances. From producing large high-density straw bales to perfectly shaped, short crop silage bales with high moisture content; the VBP 7100 series impress in every condition.



High capacity throughout the entire operation

A chain is as strong as its weakest link. Every building block is designed to ensure maximum capacity. Starting with the 3-tine INTEGRAL ROTOR and specially designed crop roller for unrestricted crop intake. A bale chamber with double tension arm for guaranteed bale start, high densities and quick re-tensioning after bale release, forms the next strong link. Followed by the quickest tailgate and bale transfer in its segment; the wrapping can start very soon after baling is finished.



Maximum durability

The heavy-duty bale chamber, rollers and drive components are a solid basis for a long lifetime of the baler. Combined with a reinforced BalePack frame and an extra-large tandem, the VBP 7100 series clearly show off their position in the highest tier of the combi balers league.

OVERVIEW



1. Second belt driven roller guarantees a secure belt drive in all crop conditions

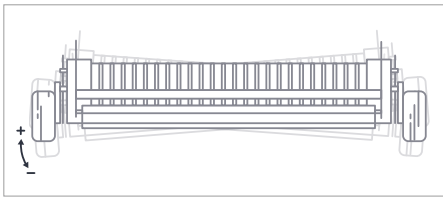

2. Pendulum pick-up

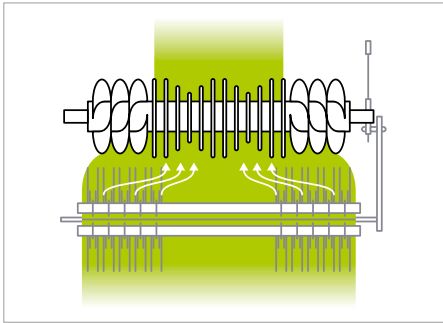

3. INTEGRAL ROTOR Technology



4. 3-tine INTEGRAL ROTORS:
OPTICUT 14 / OPTICUT 23



5. Heavy crop roller with wind guard (Ø 217 mm)



6. Net roll support brackets

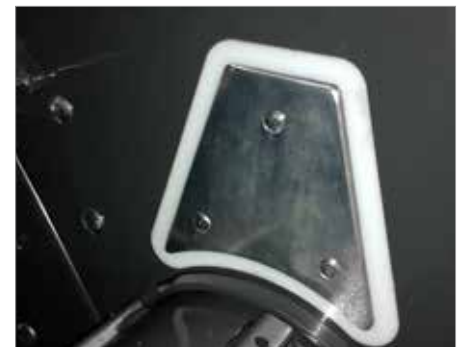

7. The patented* i-DENSE system automatically adapts the baling pressure based on moisture sensor measurements

*Patent or patent pending in one or several countries.



OPTIONS



Weighing system



3D wrapping



TWIN-reel film binding



Pivoting semi-pneumatic pick-up guide wheels



Bale turner



8. Robust driveline with wear-resistant and oversized chains



9. Extra-large tandem with 500/60R22.5 tyres



10. Automatic greasing system

BENEFIT FROM MORE EQUIPMENT



There are multiple optional accessories available that allow you to customise your baler. Benefit from a bale weighing system and moisture sensor and receive accurate real-time information on the job. Improve the performance of your baler when producing small diameter bales with the small bale kit. Or turn night into day by equipping your machine with optional work lights.



Bale weighing system

The KUHN integrated bale weighing system is available for FBP and VBP baler-wrapper combinations. Use of this system provides on-the-go feedback about the bale weight, plus direct insight in your crop yield. The system is highly accurate, even in hilly conditions due to a slope compensation sensor. You have several options to display the bale weight in the cab and integrate it into the standard field counter.



Moisture measurement

To give you the best possible information about your crop and your machine, VBP 3100 series balers can be equipped with a calibratable moisture sensor with a measuring range of up to 40% moisture content. Moisture information shows up in real time on the tractor monitor. The VBP 7100 series feature the moisture sensor as standard as a part of the i-DENSE system.



Small bale kit

The wrapper on the VBP 3100 and 7100 series can normally handle bales from 100 cm in diameter. With the small bale kit you can wrap bales from 80 cm in diameter, increasing the versatility and flexibility of your combi baler.



Vision Pack

Work day and night thanks to the optional Vision Pack for FBP and VBP, consisting of 7 LED work lights.



Full visibility

All baler-wrapper combinations can be equipped with a KUHN camera system to provide optimal visibility and safety around the machine. There are 2 kits available, one kit is compatible with the CCI terminal, the other one consists of a separate monitor and a camera.

CUSTOMERS SPEAK OUT...

THESE BALER-WRAPPER COMBINATIONS HAVE BEEN USED IN DIFFERENT COUNTRIES AND PROVEN THEIR EFFECTIVENESS IN VARIOUS SITUATIONS.



Paul Hostettler

DAIRY FARMING AND AGRICULTURAL CONTRACTING, HINTERFULTIGEN, SWITZERLAND
PRODUCES 2.000 BALES A YEAR
I-BIO+

"For us the i-BIO+ is the ideal combi machine to work in all ground conditions. It is lightweight and extremely maneuverable due to its single axle design; this makes it a very capable baler on steeper grounds. The unique Bale-In-One concept enables both baling and wrapping operations to be combined within one machine. Therefore, we only need one tractor and one operator to do the job. The KUHN INTEGRAL ROTOR system offers an enormous and unmatched throughput capacity which we are very impressed by."



John Trefor Owen

AGRICULTURAL CONTRACTING, WALES, UNITED KINGDOM
PRODUCES 13.000 BALES A YEAR
FBP 3135

"Apart from the film binding capability, which has been a game-changer for our customers, the FBP 3135 is also second to none in terms of its pick-up and intake design. Features like the rotor disengage facility are really important in terms of keeping the machine running through a range of conditions. The FBP is also very easy to use. For example, we can easily switch between the film and net binding modes, depending on what the customer wants. Working as a contractor you need to be adaptable and it's vital to have machinery that's both versatile and reliable."



Malte Benger

DAIRY FARMING AND AGRICULTURAL CONTRACTING, SÜSTEDT, GERMANY
PRODUCES 7.000 BALES A YEAR
VBP 3195

"So far, the VBP 3195 has been the only baler-wrapper to tick all boxes for our company. We are able to produce any bale size ranging from very small bales at 80 cm diameter up to 1.80-metre large bales. The film binding system on the machine is particularly helpful as we serve lots of medium-to-large dairy farmers. These customers require the best possible forage quality to produce high-quality milk. Last but not least, as a contractor, we are very satisfied with the customer service KUHN provides."



SCAN THE CODE FOR THE WHOLE STORY



SCAN THE CODE FOR THE WHOLE STORY



i-BIO+ | FBP | VBP

KUHN PREMIUM PACKAGING PRODUCTS



KUHN film, net and twine are carefully selected products enhancing the optimal performance and efficiency of KUHN balers and wrappers. Our machines are developed and tested with these premium packaging products in order to secure the optimal performance of both the packaging products and the baler or wrapper.



EXCLUSIVE

KUHN-WRAP

Consistent high-quality wrapping film with an optimal balance in ingredients and features to provide high strength, wrapping reliability and durability. KUHN-WRAP film features a typically high puncture and tear resistance in order to prevent downtime and loss of valuable crops. The wrapping film is fully recyclable.



EXCLUSIVE

KUHN-NETWRAP

Optimal bale shape and high densities are key features of KUHN balers. But if the net can't retain this, there is no use. High-strength net with a high holding force is the finishing touch of a perfect bale. KUHN-NETWRAP accomplishes the performance of the baler and optimises your results and efficiency.



KUHN PARTS



Designed and manufactured to rival time. KUHN foundries and forge as well as a high-level manufacturing process allow the production of spare parts to defy time. You can truly rely on our know-how and our genuine parts. Farmers benefit from our client support and logistics services via any KUHN PARTS warehouse, which provide quick and reliable repair solutions in cooperation with your nearest authorized KUHN dealer.

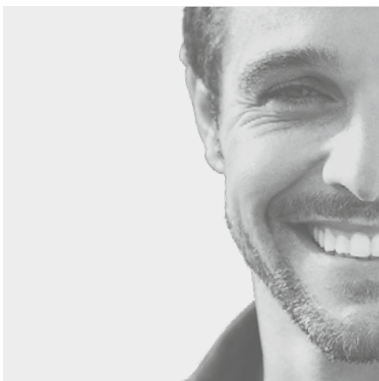

KUHN SERVICES*

- KUHN sos order** - Express spare parts service 24/7
- KUHN protect+** - The choice of professionals!
- KUHN i tech** - For ever quicker repairs!
- KUHN finance** - Invest rationally!

*Not all services and equipment are available in every country.

Technical Specifications

	I-B10+		FBP 3135		VBP 3165-3195		VBP 7160-7190	
	OPTICUT 14	OPTICUT 23	OPTICUT 14	OPTICUT 23	OPTICUT 14	OPTICUT 23	OPTICUT 14	OPTICUT 23
Bale dimensions								
Diameter (m)	1.25		1.25		0.80 - 1.60 / 1.85		0.80 - 1.60 / 1.85	
Width (m)	1.22		1.22		1.20		1.20	
Pick-up								
Pick-up width (m)	2.30		2.30		2.30		2.30	
Number of tine rows	5		5		5		5	
Tine spacing (mm)	61		61		61		61	
Pick-up wind guard	Standard		Standard		Heavy (Ø 217 mm)		Heavy (Ø 217 mm)	
Pneumatic gauge wheels	◆		◆		◆		◆	
Pivoting guide wheels	◇		◇		◇		◇	
Intake system								
Intake unit	Cutting Rotor with double tines		Cutting Rotor with double tines		Cutting Rotor with double tines		Cutting Rotor with double tines	
Theoretical cutting length (mm)	70	45	70	45	70	45	70	45
Knife protection	Individual spring		Individual spring		Individual spring		Individual spring	
GROUP SELECTION knives	0-4-7-7-14	0-7-11-12-23	0-4-7-7-14	0-7-11-12-23	0-4-7-7-14	0-7-11-12-23	0-4-7-7-14	0-7-11-12-23
Hydraulic rotor disengagement	◇		◆		-		-	
DROPFLOOR	◆		◆		◆		◆	
Automatic rotor DEBLOCK system	-		◆		◆		◆	
Automatic knife cleaning	◆		◆		◆		◆	
Binding system								
Net binding	◆		◆		◆		◆	
Net + Film binding	◇		◇		◇		◇	
Bale chamber								
Bale chamber type	Fixed chamber		Fixed chamber		Variable chamber		Variable chamber	
Bale formation	18 POWERTRACK rollers		18 POWERTRACK rollers		5 endless belts + 3 rollers with 1 tension arm		4 heavy-duty endless belts + 3 rollers with 2 tension arms	
Automatic greasing system	◇		◆		-		◆	
Operation								
Control system	ISOBUS (VTI 60 / CCI 800 / CCI 1200)		ISOBUS (VTI 60 / CCI 800 / CCI 1200)		ISOBUS (VTI 60 / CCI 800 / CCI 1200)		ISOBUS (VTI 60 / CCI 800 / CCI 1200)	
Bale pressure setting	Terminal		Terminal		Terminal		Automatic (i-DENSE)	
Moisture sensor	-		-		◇		◆ (i-DENSE)	
Independent knife/DROPFLOOR selection	Terminal		Terminal		Terminal		Terminal	
Vision Pack LED worklight set	-		◇		◇		◆	
Hydraulics								
Load Sensing	◆		◆		◆		◆	
Tyres								
2 x 500/45-22.5	◆		-		-		-	
2 x 560/45R22.5	◇		-		-		-	
2 x 650/40R22.5	◇		-		-		-	
4 x 500/45-22.5	-		◆		◆		-	
4 x 500/45R22.5 RIDEMAX	-		◇		◇		-	
4 x 500/60R22.5	-		-		-		◆	
Machine dimensions and weights								
Length (m)	4.50		6.46		6.60		7.32	
Height (m)	2.25		2.73		2.92		3.20	
Width (m)	2.75		2.99		2.99		2.99	
Weight min - max (kg)	3700 - 4500		5600 - 6300		5400 - 6300		7000 - 7900	
Power requirements								
Minimum PTO power requirement (kW / hp)	80 / 109		80 / 109		80 / 109		110 / 150	

◆ as standard ◇ optional - unavailable

MyKUHN

THE LINK TO MY SUCCESS

MyKUHN is your on-line customer space. Sign up now and discover how the exclusive services offered by MyKUHN will facilitate the management of your fleet of KUHN machines and terminals as well as help you maximize their performance. Once identified, on computer, smartphone or tablet, you will have access to parts catalogs, technical documentation and numerous connected services.



Check out KUHN's complete full-liner range in baling and wrapping equipment:



1. Fixed Balers - 2. Variable Balers - 3. Large Square Balers - 4. Round Bale Wrappers - 5. Round Bale Wrappers - 6. Round and Square Bale Wrappers

KUHN NORTH AMERICA, INC. - Corporate Headquarters - 1501 West Seventh Avenue - P.O. Box 167 - Brodhead, WI 53520-0167 USA

KUHN FARM MACHINERY PTY. LTD - 313-325 Foleys Road - Deer Park, VIC, 3023 - Australia

KUHN FARM MACHINERY (U.K.) LTD - Stafford Park 7 - GB TELFORD/ SHROPS TF3 3BQ

KUHN-GELDROP B.V. - Nuenenseweg 165 - P.O. Box 9 - 5660 AA Geldrop - The Netherlands

For more information about your nearest KUHN dealer,
visit our website www.kuhn.com

Information given in this document is only for information purposes and is non-contractual. Our machines are in compliance with regulations in force in the country of delivery. In our literature, and for improved illustration of certain details, some safety devices may not be in operating position. When operating these machines, these devices must be in position in accordance with the requirements indicated in the operator's manuals and assembly manuals. Respect the tractor gross vehicle weight rating, its lift capacity and maximum load per axle and tyres. The tractor front axle load must always comply with the regulations of the country of delivery (In Europe, it must reach minimum 20% of the tractor net weight). We reserve the right to change any designs, specifications or materials listed without further notice. Machines and equipment in this document can be covered by at least one patent and/or registered design. Trademarks cited in this document may be registered in one or several countries.

To protect the environment, this leaflet is printed on chlorine-free paper.
Printed in the Netherlands - REF: ZPAF30GB - 03-23 - Copyright 2022 KUHN

