

Triple Gang Disc Mower Combinations



# GMD TRIPLE GANG MOWERS FC TRIPLE GANG MOWER CONDITIONERS

[www.kuhn.com](http://www.kuhn.com)



be strong, be **KUHN**



GMD

3125 F 3525 F 8730 9530 10030

FC

3125 F 3525 F 8830 9530 10030

# MAXIMIZING OUTPUT. OPTIMIZING FORAGE.

KUHN has developed new GMD mowers and FC mower conditioners to support you in the inevitable race for output. Farms have increasingly larger areas to harvest, optimal mowing periods are limited, and achieving a top-quality forage is essential. In these times, you can count on the performance, work quality and reliability of KUHN solutions.

## ENSURE A REGULAR CUTTING HEIGHT

An immaculate ground adaptation is an absolute precondition to obtain a regular cut and proper forage on rolling ground and slopes. The topic becomes all the more important, the wider the working width is. KUHN joins here by proposing sophisticated technical solutions to achieve both a high vertical and angular travel range.

## HARVEST THE BEST OF THE PLANT

KUHN large-width mowers and mower conditioners have some points in common to ensure that you cut all the forage and this of high quality: LIFTCONTROL hydro-pneumatic suspension, OPTIDISC cutter bar, lateral displacement options and more.

## REFERENCES IN TERMS OF RELIABILITY

From the PROTECTADRIVE safety on the cutter bar to a hydraulic safety break-away... it is no coincidence that KUHN mowers are the reference in the market.

## KUHN's large-width GMD mowers and FC mower conditioners in brief:

	Working widths (m)	Swath widths (m)	No. of discs	Conditioner
GMD 3125 F / 3525 F	3.10 / 3.50	1.00 - 1.20	7 / 8	NO
GMD 8730	8.20 - 8.75	2 x 2.40	2 x 7	
GMD 9530	9.13 - 9.53	2 x 2.80	2 x 8	
GMD 10030	9.53 - 9.93	2 x 2.80	2 x 8	
FC 3125 F / 3525 F	3.10 / 3.50	1.20 - 2.00	7 / 8	YES (pivoting steel fingers)
FC 8830	8.33 - 8.73	1.45 - 2.10	2 x 7	
FC 9530	9.13 - 9.53	1.85 - 2.40	2 x 8	
FC 10030	9.53 - 9.93	1.85 - 2.40	2 x 8	



# EXCELLENT GROUND ADAPTATION TOP-QUALITY FO



Your main goal is to produce as much milk and meat out of the basic ration? KUHN is at your side to achieve high quality forage with minimum soil levels and rich in energy and nutrient. On the new GMD and FC triple mowers, special features are built in to facilitate ground contouring and thus improve the cutting quality and leave an undamaged grass stubble.



## FLEXIBLE FRONT UNITS THAT ADAPT TO THE LAND

The frame of the GMD and FC 3125/3525 front mowers integrates a suspension unit, enabling the mowing unit to put large travel ranges into practice. We are talking about an angular movement range of 30° and a vertical displacement of nearly 70 cm, while the ground pressure is kept constant all the way! The unit's pendulum-type articulation serves of course as basis for the high travel ranges.



# MEANS RAGE!



## IMPRESSIVE TRAVEL RANGE OF REAR UNITS

The GMD and FC rear units follow virtually all ground contours. The following list of features underlines this:

- pendulum-type articulation of units,
- hydraulic side shifting of 20 cm,
- a vertical travel range of nearly 50 cm,
- an angular flexibility from +13.3° to -8.1° at 50 cm overlapping.

Impressive numbers you say: You can be sure that KUHN has done everything for improving your forage!

# A GOOD MATCH!



## NARROW SWATHS ON DEMAND

The front mowers' swath width can be reduced to a minimum of 1.00 to 1.20 m, if needed in order not to drive over it with the tractor wheels. In this way the forage is not run flat and contaminated by soil.



## NOTHING IS LEFT UNCUT

For a clean and complete cut on slopes and in sharp bends, the mower units can be shifted laterally by 20 cm to create an increased overlapping between the front and rear units.

Depending on the model combination, overlaps from 30 cm up to 70 cm are possible. The driver can modify the working width during work from the cab. This feature is a real benefit for tractors with wide tracks or large wheels.





# CLEAN FORAGE FOR HIGHER REVENUES

Any profits from animal husbandry start with the feed reserves stored in a silo, bales, or bunk. The aim is simple: produce as much meat or milk as possible from the basic feed ration components. To promote this objective, the feed's palatability must be optimized, encouraging as much uptake as possible while at the same time providing the maximum nutritional value. In this way you can considerably reduce the requirements for concentrates and supplements thus increasing profitability.

## LOWERING THE LEVEL OF IMPURITIES FROM 4 % TO 2 % SAVES 89 EUROS PER HECTARE AND YEAR!

Studies, performed in a German region of intensive production, have determined the financial effect of the silage quality on a dairy farm. Researchers compared two types of silage: the first with 2 %

impurities and the second with 4 %. After measuring the nutritional effect of the poorer quality silage, they calculated the value of concentrate to add to reach the same production level. The financial effect was found to be 89 €/ha/year!

### ENERGY UPTAKE PER COW PER YEAR

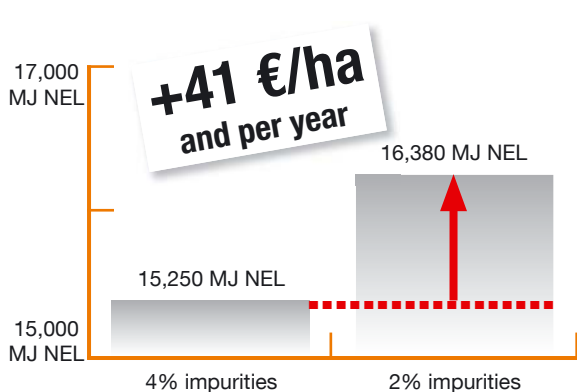

### ENERGY CONTENT PER HA AT A YIELD OF 10 T DRY MATTER

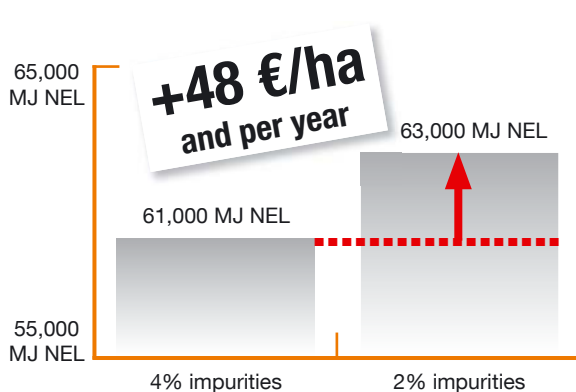

## THE SOLUTION: LIFT-CONTROL FOR...



**Improved mowing** – excellent ground contouring - less crop contamination – nutritional value preserved – grass stubble protection for faster regrowth.



**Reduced costs** – less tensile forces - less fuel consumption – less wear and lateral forces – less concentrates needed – increased working speed – increased productivity.



**Easier work** – adjustments from the cab – pressure gauge for accurate adjustment – easy passage of obstacles – Non-Stop safety breakaway.

# KUHN'S KEY FOR A CLEAN CROP: LIFT-CONTROL



Scan this QR-code with your Smartphone to see firsthand how LIFT-CONTROL works.

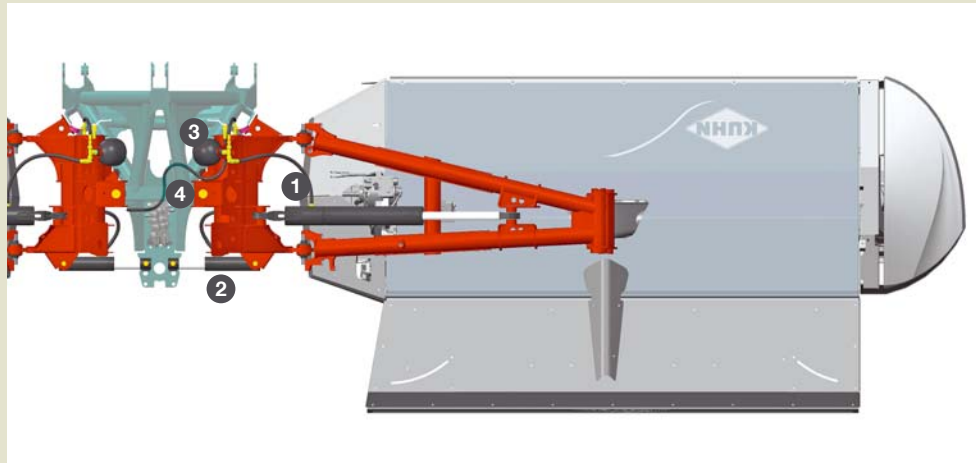

## CLEVER KINETICS

LIFT-CONTROL is much more than just a suspension system with a nitrogen accumulator replacing the traditional spring. The principal advantage of the LIFT-CONTROL system is derived from the exclusive way in which kinetic forces that act on the cutter bar are utilized. KUHN engineers have succeeded in making a dynamic suspension system as opposed to the passive system commonly in use.

## HOW DOES LIFT-CONTROL WORK IN PRACTICE?

The particular kinematics of KUHN triple gang mowers integrate a suspension cylinder for lightening the mowing unit (1), a break-away cylinder (2), an accumulator with adjustable pressure (3) and a pivot axis well positioned and close to the machine center (4).

The appropriate suspension adjustment limits mixing impurities in the crop and reduces the cutter bar ground pressure: less fuel consumption, skid wear and grass stubble protection.

# Active Non-Stop safety break-away

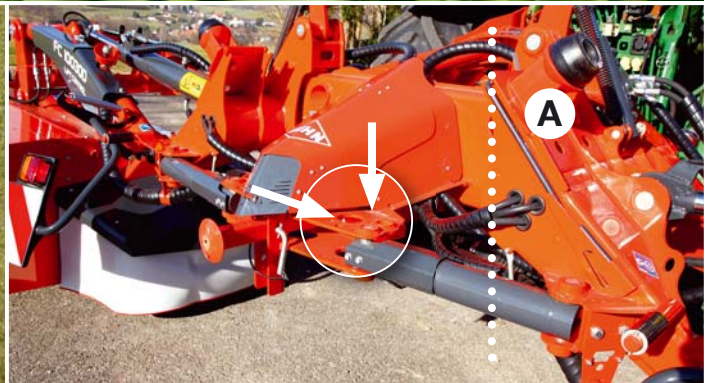

## MOW WITH YOUR MIND AT EASE!

No farmer can afford to damage his mower during the peak season because of an unnoticed obstacle or a false manoeuvre. On the new KUHN triple gang mowers, the mowing unit pivots rearwards around the pin (4) when hitting an obstacle. In this moment, oil is transferred towards the suspension cylinder. The resulting pressure increase facilitates the mowing unit raising to clear the obstruction. Return to the initial working position is carried out Non-Stop.

## A WELL CONCEIVED HYDRAULIC SAFETY

- The safety remains efficient even if the obstacle is hit by the inner discs of the mowing unit, as the pivoting point of the frame arm (A) is positioned far inside.
- An independent suspension on each mowing unit prevents the opposite mowing unit from being accelerated forward when the other side clears the obstacle.
- The hydraulic break-away can be adjusted depending on the cutting conditions. The cylinder is fixed on two points (arrows): The second fixation allows to increase the force required for the break-away, for example when working at high speed in rough conditions.

# OPTIDISC: THE OPTIMUM CUT!

The KUHN OPTIDISC cutter bar is an excellent example how a close cooperation of farmers and manufacturer can generate real added value and solutions adapted to practice. It combines in a unique way an unmatched cutting quality with great reliability and user comfort. Luded for life and adapted to high power tractors, it perfectly responds to the requirements of large farms and contractors.



## A CUTTER BAR THAT STANDS OUT

A high cutting quality is essential when thinking about the concentrate savings possible thanks to an optimized forage quality. In this way, the most important OPTIDISC characteristic is the differing spacing between the discs.

## PROTECTIVE SKIDS

Sticky crop conditions may implicate some accumulation of soil in front of the cutter bar: but not with OPTIDISC! Its skids are designed in a way to improve sliding and protect the grass stubble, thus ensuring high forage quality also in difficult conditions.

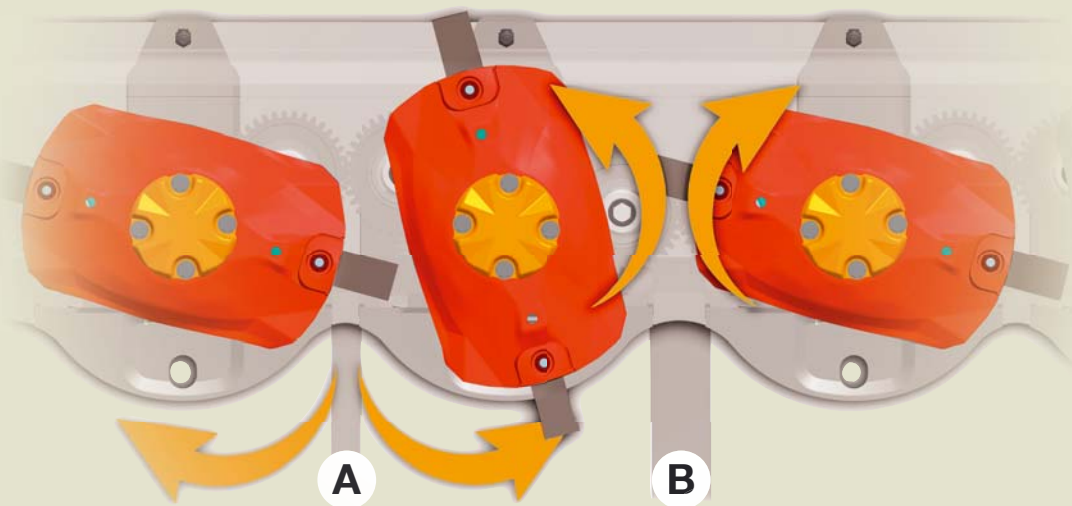

## LESS DISTANCE FOR A CLEAN CUT

At the point where the discs diverge, the distance between them is reduced to increase knife overlap. This results in a clean cut even when the grass is short or light.

## MORE DISTANCE FOR EASY CROP PASSAGE

More space is provided in the overlap area between converging discs for the crop to pass through more easily. Cut crop is quickly evacuated to the rear, thus not disturbing the mower work.

## FAST-FIT: 100 % SAFE KNIFE ATTACHMENT

The FAST-FIT quick-release knife mount system is standard on KUHN's GMD and FC triple gang combinations. It enables to exchange all knives in just a few moments. A powerful leaf spring that can't be released when the disc is rotating, provides constant pressure to the knife retainer for top securement.





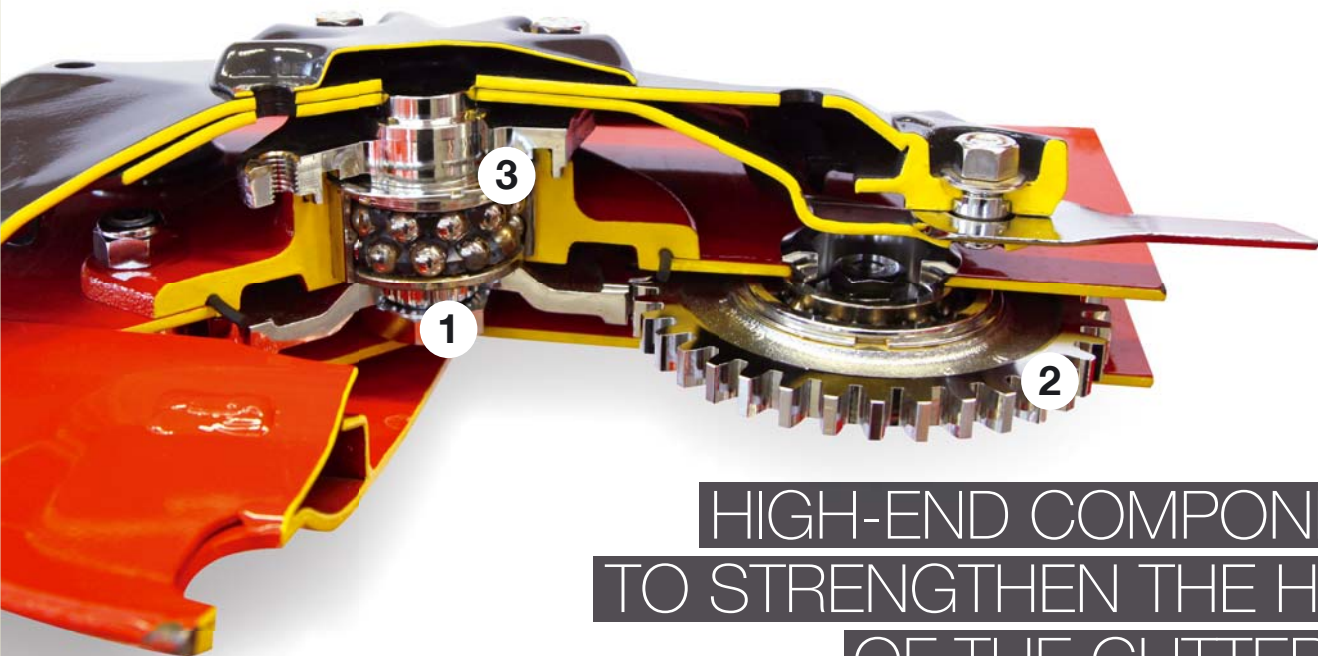

## HIGH-END COMPONENTS TO STRENGTHEN THE HEART OF THE CUTTER BAR

- ① The disc bearing stations are fitted with double row angular ball bearings. ② Large-diameter gearwheels made of forged steel with high machining precision: This feature ensures maximum resistance which is all the more important should a disc hit an obstacle.  
③ PROTECTADRIVE safety.

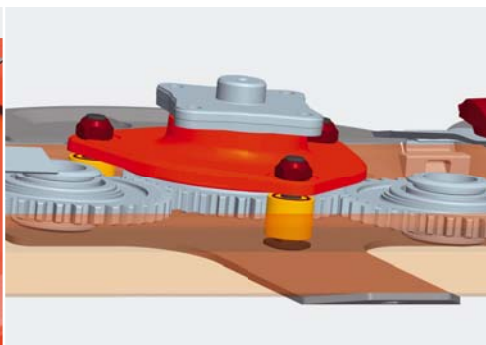
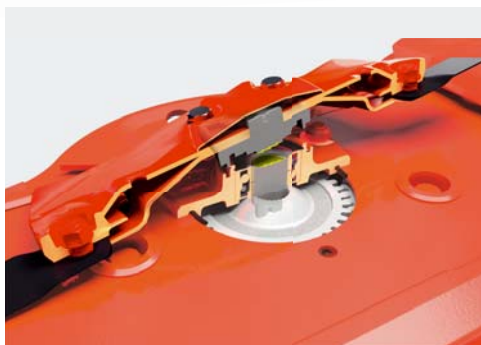

### PROTECTADRIVE PROTECTS THE MOST PRECIOUS PARTS

Every minute saved during the season is important: in the event of a very violent impact between a disc and an obstacle, the shaft holding the disc can shear just above the bearing, thanks to a carefully dimensioned shear groove. The precious toothed wheels are protected. The saving is enormous: in less than 15 minutes the mower is operational once more at a very low repair cost!

### EXCLUSIVE

#### EXTRA RIGIDITY WHERE IT COUNTS!

Disc bearing stations are attached by bolts that pass through the entire cutter bar. This is an exceptionally strong and secure attachment with no risk of mount being torn out of the cutter bar in case of shocks. The disc drive pinion is held precisely in place, all resulting in an excellent reliability and reduced repair costs.

### EXCLUSIVE

#### NEW FIXATION OF CUTTER BAR TO CHASSIS

Shock absorbers are now integrated in the connection between cutter bar and chassis. They efficiently absorb shocks during work when driving quickly. A real trump for long service life!



be strong, be **KUHN**

## KUHN PARTS

DESIGNED AND MANUFACTURED  
TO RIVAL TIME



KUHN foundries and forge as well as a high-level manufacturing process allow the production of spare parts to defy time. You can truly rely on our know-how and our genuine parts. Farmers benefit from our client support and logistics services via any KUHN PARTS warehouse, which provide quick and reliable repair solutions in cooperation with your nearest authorized KUHN dealer.



GMD

3125 F

3525 F

FC

3125 F

3525 F

# MODERN STYLE MEETS GREAT PERFORMANCE

The first impression counts: and this one is very attractive, when looking at the new KUHN GMD front mowers and FC front mower conditioners. But the inside also deserves a closer look, as these new models feature so many functional KUHN characteristics that it is difficult not to forget one:

- a special frame design for an unmatched ground adaptation;
- the maintenance-free OPTIDISC cutter bar for an optimum cut;
- PROTECTADRIVE safety and FAST-FIT quick-release knife system;
- the hydro-pneumatic LIFT-CONTROL suspension of the mowing unit;
- easy adjustments for increased user comfort;
- a conditioner rotor with pivoting steel fingers on FC 3125 F and FC 3525 F;
- a strong and safe cat. 2 attachment (no A frame) also providing a high clearance for the PTO shaft.

## EXCLUSIVE

### A NEW FUNCTIONAL LOOK

The new KUHN GMD and FC front mowers come along with an attractive, but also especially functionally designed headstock. The compact frame, based on a shark fin, offers improved visibility and subtly

integrates the suspension unit, which is responsible for an exceptionally high ground adaptation. The two support arms are positioned way apart from each other, thus ensuring that the mower runs stable.



### SUPPORT ARMS THAT DYNAMISE

The highly specific kinematics of these machines include two strong lower connecting rods mounted on extra-large ball joints. The connecting rods are attached to the tractor in a lower position than at the front. This creates dynamic stress during operations which produces a lift-effect on the mower unit and makes a considerable difference to ground contour following in hilly areas.



## GREAT TERRAIN FOLLOWERS

Front mowing units have to remain flexible enough to smoothly adapt to all terrain changes, they may encounter. At the same time they are often subject to higher stress. The KUHN GMD/FC front mowers are designed for this purpose, featuring a pendulum-type articulation of the mowing unit and significant displacement opportunities. They can oscillate left to right at an angle of up to 30° and cover a vertical travel range of nearly 70 cm!

### QUICK AND EASY SETTINGS

User comfort is one of the pressing topics at KUHN. On new GMD/FC 3125 F/3525 F, ground pressure can be easily and quickly set via a hydraulic suspension, always keeping it at the right level in this way. On the headland, units are lifted with the support of an integrated cylinder. The tractor's front hydraulics thus remain untouched at work. On the FC front models, the selection of the two conditioning speeds (755 or 1,000 min<sup>-1</sup>) is simply done by adjusting a central lever.

### NARROW SWATH. PROPER FORAGE.

Different devices arrange to deliver a narrow swath in order not to drive over it with the tractor wheels and tamp it down into the soil. On the front GMD mowers, one driven swath drum on each side groups the crop and in this way reduces the swath width down to 1.00 to 1.20 m. The conditioner rotor helps to reduce the swath down to 1.20 m on the FC models.



### WIDE AND MODULAR OVERLAP

For a clean cut on slopes and bends, the overlap between the front and rear units can be adjusted hydraulically between 30 and 70 cm (depending on the model combination) - even while driving. This is a real benefit for tractors with wide tracks or large wheels.

### FLEXPROTECT: FLEXIBLE PROTECTION

Twisted side covers after having hit an obstacle: not on the new KUHN front GMD and FC mowers! In this event, the FLEXPROTECT polythene side covers bend without breaking or damaging the mower. After the obstacle's passage, the material automatically returns back to its original shape.

GMD 8730



# GREAT OUTPUT WITH MINIMUM ENERGY CONSUMPTION

High output accessible to everyone with minimal power requirement: These are the main characteristics of this triple combination. Weighing less than 1,800 kg, it can be used according to the conditions with tractors starting at 120 hp. With the LIFT-CONTROL hydro-pneumatic mowing unit suspension and the maintenance-free OPTIDISC cutter bar, the GMD 8730 features convincing solutions for increased comfort and time savings.



## LIFT-CONTROL: SAVINGS ALL ALONG THE LINE

Because time is money, adjusting weight-reducing pressure takes just a few seconds! The folding cylinders include an extra chamber connected to nitrogen balls. In this way, it is easy to adjust the pressure to harvesting conditions. The Non-Stop hydraulic safety provides flexible individual protection and reactivates the two mowing units after having passed the obstacle.

It is when mowing on slopes that the LIFT-CONTROL system shows all its advantages and is reflected in a distinct reduction of fuel consumption and higher working rate.

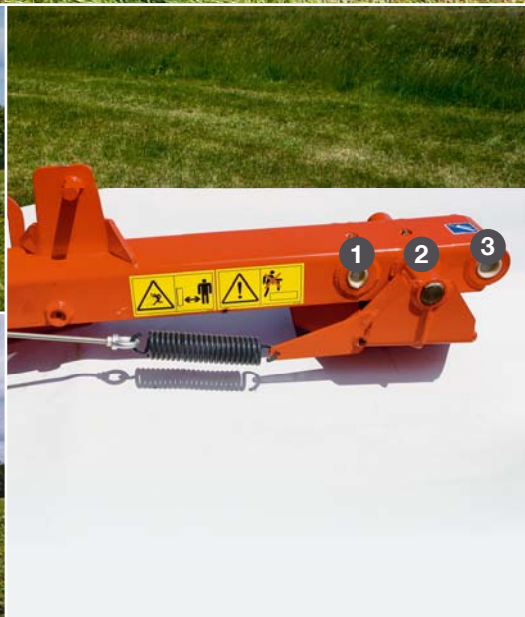

**INDIVIDUAL LIFT OF MOWING UNITS AS STANDARD**

When working, you only have to handle one valve to lift the front-mounted mowing unit and one for the rear units. The possibility of lifting both rear mowing units individually is a big advantage on wedge-shaped fields and allows quick and easy manoeuvres. The concerned unit is put into transport position by manipulating a two-way hydraulic valve.

**THE MOWING UNIT WHICH SUITS YOUR NEEDS...**

Three positions (1, 2, 3) are available for mounting the mowing units on the arms: Depending on working conditions (slope, size of field, width of front unit, etc.), you can choose the total cutting width or more overlap between front and rear-mounted units.

**SPACE-SAVING STORAGE**

It's the compact dimensions that stand out, when the GMD 8730 triple gang mower is folded for storage. The machine can be parked vertically without additional equipment necessary. Be sure: The machine fits in almost every shed.

# « LARGE-WIDTH » DREAMS...

Output is the factor that counts on large operations, but it's the extra MJ of energy and avoided percentage of soil in the forage that makes the real difference also for large farms and contractors.

The working widths of 9.13 to 9.53 and 9.53 to 9.93 m for the two models respectively, speak for themselves, the following features adding the cherry to the cake:

- a special frame design for an unmatched ground adaptation;
- a central pendulum-type articulation of the mowing unit;
- a large and flexible cut overlap between front and rear units;
- the maintenance-free OPTIDISC cutter bar for an optimum cut;
- PROTECTADRIVE safety and FAST-FIT quick-release knife system;
- the hydro-pneumatic LIFT-CONTROL suspension of the mowing unit.

## STAY RELAXED IN THE CAB

Via the KFA11 control box several adjustments can be done stress-free and comfortable from the cabin.

The standard functions include:

- control of LIFT-CONTROL hydro-pneumatic suspension;
- individual lifting of cutting units.



### SEPARATE HYDRAULIC LIFTING OF UNITS

The possibility of lifting both rear mowing units individually via hydraulic cylinders is a big advantage on wedge-shaped fields and permits quick and easy manoeuvres. This can be done directly from the cabin via KFA11. At the same time the system ensures a reduced ground pressure: beneficial to plant cover, cutter bar wear and power input.

### ROAD TRANSPORT AT EASE

Transporting a butterfly combination in upward folded position leaves it closer to the tractor, which has undeniable strong points:

- compact dimensions on the road (reduced length),
- centre of gravity close to the tractor,
- reduced load on the rear tractor axle.

### PRACTICAL STORAGE POSITION

Two parking stands are delivered as standard with the machine. They enable you to park the machine in folded position, this considerably saving storage space.



# SIMPLY GREAT FORAGE!

**Did you know that you can save concentrates worth 89 €/ha and year, just by reducing the impurities in the forage from 4 to 2 %\*? We are at your side to help you produce forage of top quality to realize according gains.**

We would like to pass on our know-how in forage production, gathered during several decades of producing hay/silage making implements.

We provide advice for you to produce first-class animal feed. We help you to understand the strong points of our machines in order that you can use them in an optimal way to preserve the quality of your forage.

*\*Source: Agricultural chamber Weser-Ems, Germany.*

**With the KUHN expertise, you will harvest forage with...**

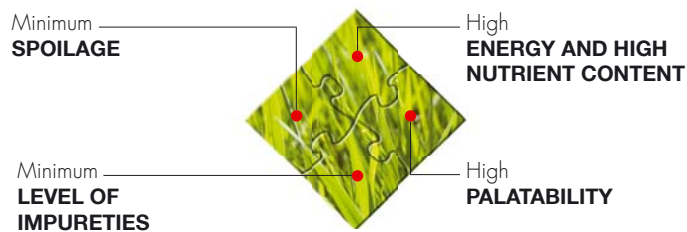

Find all our expertise on [forage.kuhn.com](http://forage.kuhn.com)

FC

8830

9530

10030

# QUALITY CUT. QUALITY CONDITIONING.



Also the three new mower conditioners from KUHN achieve exceptional working widths of 8.73, 9.53 and 9.93 m (depending on the front mower). They fulfil all of the strong points that also characterize their siblings, the GMD 9530 and 10030 butterfly mowers, but adding one more: a performing conditioner.



## HYDRAULIC AND INDIVIDUAL LIFTING OF CUTTING UNITS

Both mower units can be lifted individually, which is especially important when working on field points. The integrated system works hydraulically, thus enabling quick manoeuvres in great comfort, while a reduced ground pressure is ensured. The latter is beneficial to plant cover, cutter bar wear and power input.



## COMFORTABLE ADJUSTMENTS FROM THE CAB

The KFA11 terminal considerably facilitates machine adjustments.

- Following functions can be comfortably controlled from the cab:
- folding/unfolding,
  - independent lifting of the mowing units,
  - ground pressure of mowing units.



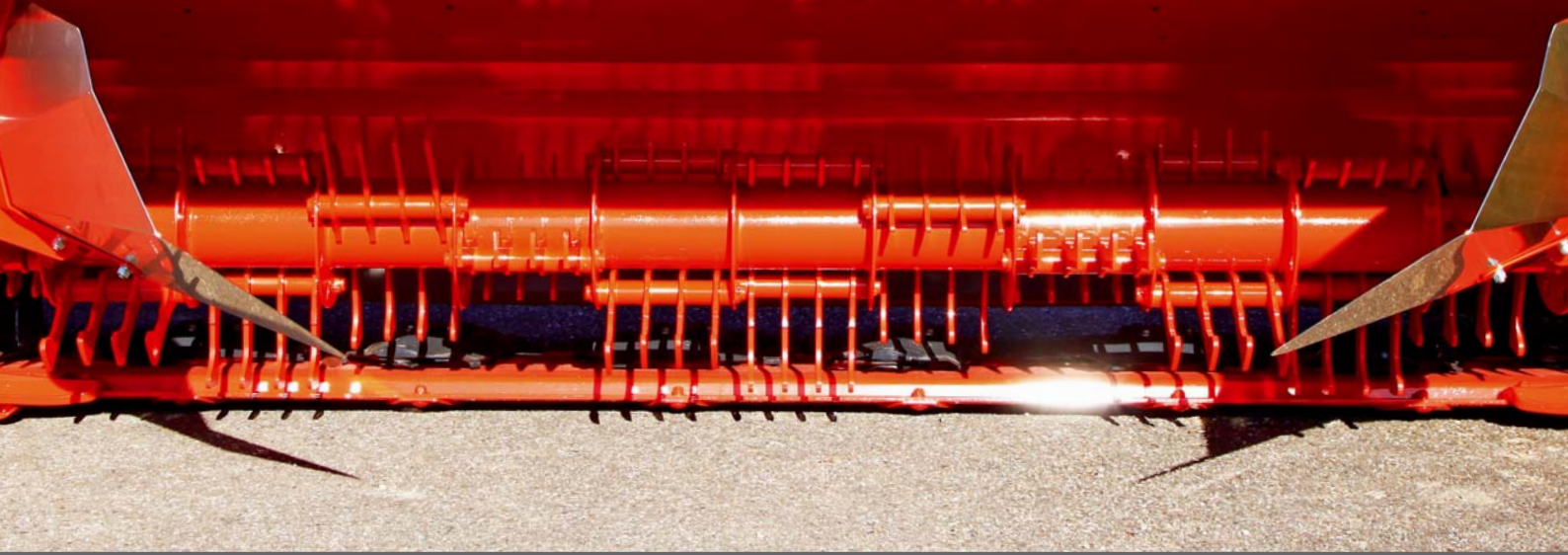

# A CONDITIONER MADE TO PERFORM

The 540 mm rotor with pivoting steel fingers stands out by its high transport capacity, making a large and regular crop throughput possible also under difficult conditions. For conditioning heavy or long forage, only limited power is required. The pivoting fingers can avoid foreign material, when necessary. And you have the deposit choice: either deliver the forage on a swath or spread it over the whole working width.



## ROTOR SPEED: YOUR CHOICE AND COMFORT!

The conditioner can be quickly adapted to different forage types by a central two-speed lever. Slow the rotor speed down for delicate crops and to reduce the fuel consumption for example during late cuts with less forage (755 min<sup>-1</sup>) and speed up for dense grasses (1,000 min<sup>-1</sup>).



## EXCLUSIVE

### BUILT-IN ROTOR PROTECTION

The conditioner rotor's drive shaft is protected on its shaft extension by a shear bolt. Should a foreign body pass through the machine or in the unlikely event of crop overloading, the conditioner and gearbox are in total safety.



## SIDE COVER DAMAGE BELONGS TO THE PAST

On encountering an obstacle, the KUHN FLEXPROTECT side covers made of polythene material bend without breaking or damaging the mower. The material then returns back to its original shape. They fold automatically without having to use an additional tractor valve.





### Technical specifications

	<b>GMD 3125 F</b>	<b>GMD 3525 F</b>	<b>GMD 8730</b>
Working width per cutting unit (m/ft)	3.10 / 10'2"	3.50 / 11'6"	3.10 / 10'2"
Possible working widths of triple combination (m/ft)	-		8.20 - 8.45 - 8.75 / 26'11" - 27'9" - 28'8"
Overlapping front/rear unit (cm/in)	With GMD 8730: 28 - 43 - 55 / 11" - 16.9" - 21.7" With GMD 9530: 30 - 50 / 11.8" - 19.7"	With GMD 9530: 50 - 70 / 19.7" - 27.6" With GMD 10030: 30 - 50 / 11.8" - 19.7"	With GMD 3125 F: 28 - 43 - 55 / 11" - 16.9" - 21.7"
Swath width (m/ft)	1.00 - 1.20 / 3'3" - 3'11"		2x 2.40 / 2x 7'10"
Attachment	3-point, cat. 2		
PTO speed (min <sup>-1</sup> )			
Primary PTO shaft			
Drive safety			
Free wheel			
Cutter bar			
Number of discs with safety skids made of hardened steel	7	8	2x 7
Hydro-pneumatic suspension system LIFT-CONTROL			
Ground adaptation			
Hydraulic ground pressure adjustment			
Conditioning system	-		
Headland turn position	via hydraulic cylinder		via integrated hydraulic
Swathing system	2 driven swath drums		
Wide spreading system	-		
Transport width (m/ft)	2.99 / 9'10"	3.48 / 11'4"	3.00 / 9'10"
Transport height (m/ft)	-		3.99 - 3.84 - 3.72 / 13'1" - 12'7" - 12'2"
Side guards	FlexProtect		Protective cover and safety bar
Machine storage	flat		vertically folded
Lighting and signalling			
Min. PTO power requirement (kW/hp)	32 / 43	36 / 49	90 / 122*
Tractor hydraulic requirements	1x SA		1x DA + 1x SA
Tractor electric requirements	1x 7-pin plug		1x ISO 7-pin plug and 1x ISO 3-pin plug
Weight (kg/lbs)	1,105 / 2,440	1,180 / 2,600	1,760 / 3,880

\* Numbers valid for entire triple combination.

## Triple Gang Disc Mowers and Mower Conditioners

GMD 9530		GMD 10030		FC 3125 DF		FC 3525 DF		FC 8830 D		FC 9530 D		FC 10030 D							
3.50 / 11'6"				3.10 / 10'2"				3.50 / 11'6"				3.10 / 10'2"				3.50 / 11'6"			
9.13 - 9.53 / 29'10" - 31'2"		9.53 - 9.93 / 31'2" - 32'6"		-				8.33 - 8.73 / 27'3" - 28'7"				9.13 - 9.53 / 29'10" - 31'2"		9.53 - 9.93 / 31'2" - 32'6"					
With GMD 3125 F: 30 - 50 / 11.8" - 19.7"		With GMD 3525 F: 30 - 50 / 11.8" - 19.7"		With FC 8830 / 9530: 30 - 50 / 11.8" - 19.7"		With FC 8830/9530: 50 - 70 / 19.7" - 27.6"		With FC 10030: 30 - 50 / 11.8" - 19.7"		With FC 3125 F: 30 - 50 / 11.8" - 19.7"				With FC 3525 F: 50 - 70 / 19.7" - 27.6"		With FC 3525 F: 30 - 50 / 11.8" - 19.7"			
2x 2.80 / 2x 9'2"				1.20 - 2.00 / 3'11" - 6'7"				2x 1.45 - 2.10 / 2x 4'9" - 6'11"		2x 1.85 - 2.40 / 2x 6'1" - 7'10"									
3-point, cat.3 or 4N (compatible with Quick-Hitch, cat.3 or 4N)				3-point, cat. 2				3-point, cat.3 or 4N (compatible with Quick-Hitch, cat.3 or 4N)											
1,000																			
1 3/8" 6 or 21 splines, 1 3/4 20 splines																			
friction slip clutch																			
◆ (integrated in the lateral gearbox)																			
OPTIDISC (with FAST-FIT knife attachment and PROTECTADRIVE safety)																			
2x 8				7				8				2x 7				2x 8			
◆																			
pendulum-type articulation of mowing units																			
◆																			
rotor with pivoting steel fingers with conditioning hood adjustable in 5 positions																			
device; simultaneous or individual lifting possible				via hydraulic cylinder				via integrated hydraulic device; simultaneous or individual lifting possible											
outer swath wheel				via conditioner rotor															
◆																			
2.95 / 9'7"		3.35 / 11'		2.99 / 9'10"		3.50 / 11'5"		2.95 / 9'7"				3.35 / 11'							
3.90 / 12'9"				-				3.50 / 11'5"		3.90 / 12'9"									
FlexProtect (hydraulic folding as standard)				FlexProtect				FlexProtect (hydraulic folding as standard)											
vertically folded on two parking stands				flat				vertically folded on two parking stands											
◆ (in accordance with the regulations in the country of destination)																			
99 / 135*		104 / 141*		50 / 68		57 / 77		140 / 191*		154 / 210*		162 / 221*							
2x DA				1x SA				2x DA (+ 1x DA for hydraulic 3-point link)											
1x 7-pin plug and 1x ISO 3-pin plug				1x 7-pin plug				1x 7-pin plug and 1x ISO 3-pin plug											
2,300 / 5,070		2,350 / 5,180		1,320 / 2,910		1,390 / 3,065		3,030 / 6,680		3,210 / 7,075		3,260 / 7,185							

◆ standard ◊ option - not available

KUHN

APPS

# SMALL PROGRAMS WITH GREAT IMPACT

## FOR POWERFUL HARVESTING SYSTEM SOLUTIONS

The forage harvesting chain is only as strong as its weakest link. It's important that all machines do well interlock. In this context, the KUHN ForageXpert app can support you in optimizing your harvest system according to your current equipment. With this tool you can quickly find the mower, mower conditioner, tedder and rake that are best adapted to your existing forage machines.

Available on the Apple Store as well as Google Play.



Scan this code for direct access to KUHN ForageXpert.



## Check out the extensive KUHN range for large grassland operations!

1. Gyrotedders up to 17 m
2. Twin-rotor Gyrorakes
3. Four-rotor Gyrorakes
4. Belt mergers



For more information about your nearest KUHN dealer, visit our website [www.kuhn.com](http://www.kuhn.com)



Visit us on our YouTube channels.

 <a href="http://www.kuhn.com">www.kuhn.com</a>	Your KUHN dealer
---	------------------

**KUHN S.A.**  
 4 Impasse des Fabriques - BP 50060  
 F-67706 Saverne CEDEX - FRANCE

**KUHN NORTH AMERICA, INC.**  
 1501 West Seventh Avenue - Brodhead,  
 WI 53520 - USA

**KUHN FARM MACHINERY PTY. LTD**  
 313-325 Foleys Road - Deer Park, VIC, 3023 - AUSTRALIA

**KUHN FARM MACHINERY (U.K.) LTD**  
 Stafford Park 7 - GB TELFORD/ SHROPS TF3 3BQ

Information given in this document is only for information purposes and is non-contractual. Our machines are in compliance with regulations in force in the country of delivery. In our literature, and for improved illustration of certain details, some safety devices may not be in operating position. When operating these machines, these devices must be in position in accordance with the requirements indicated in the operator's manuals and assembly manuals. Respect the tractor gross vehicle weight rating, its lift capacity and maximum load per axle and tyres. The tractor front axle load must always comply with the regulations of the country of delivery (In Europe, it must reach minimum 20 % of the tractor net weight). We reserve the right to change any designs, specifications or materials listed without further notice. Machines and equipment in this document can be covered by at least one patent and/or registered design. Trademarks cited in this document may be registered in one or several countries.

Also find KUHN on

