

BT-50



mazda



zoom-zoom

IMAGINATION DRIVES US



Imagination is the world's most valuable resource. It's our window to the future, because if we can imagine it, we can create it. Mazda is built on a foundation of imagination and ingenuity. It's the fuel behind all we create and achieve. It has given us countless successes that once existed only in someone's imagination. These pages show how imagination is an integral part of our innovative cars.

CONTENTS

04	INTRODUCTION
06	EXTERIOR
08	INTERIOR
10	DYNAMICS
12	PERFORMANCE
14	UTILITIES
20	FEATURED INNOVATION
22	CAPABILITY
24	SAFETY
26	ACCESSORIES
28	MODELS
34	SPECIFICATIONS
42	CONFIDENCE
43	COLOUR & TRIM

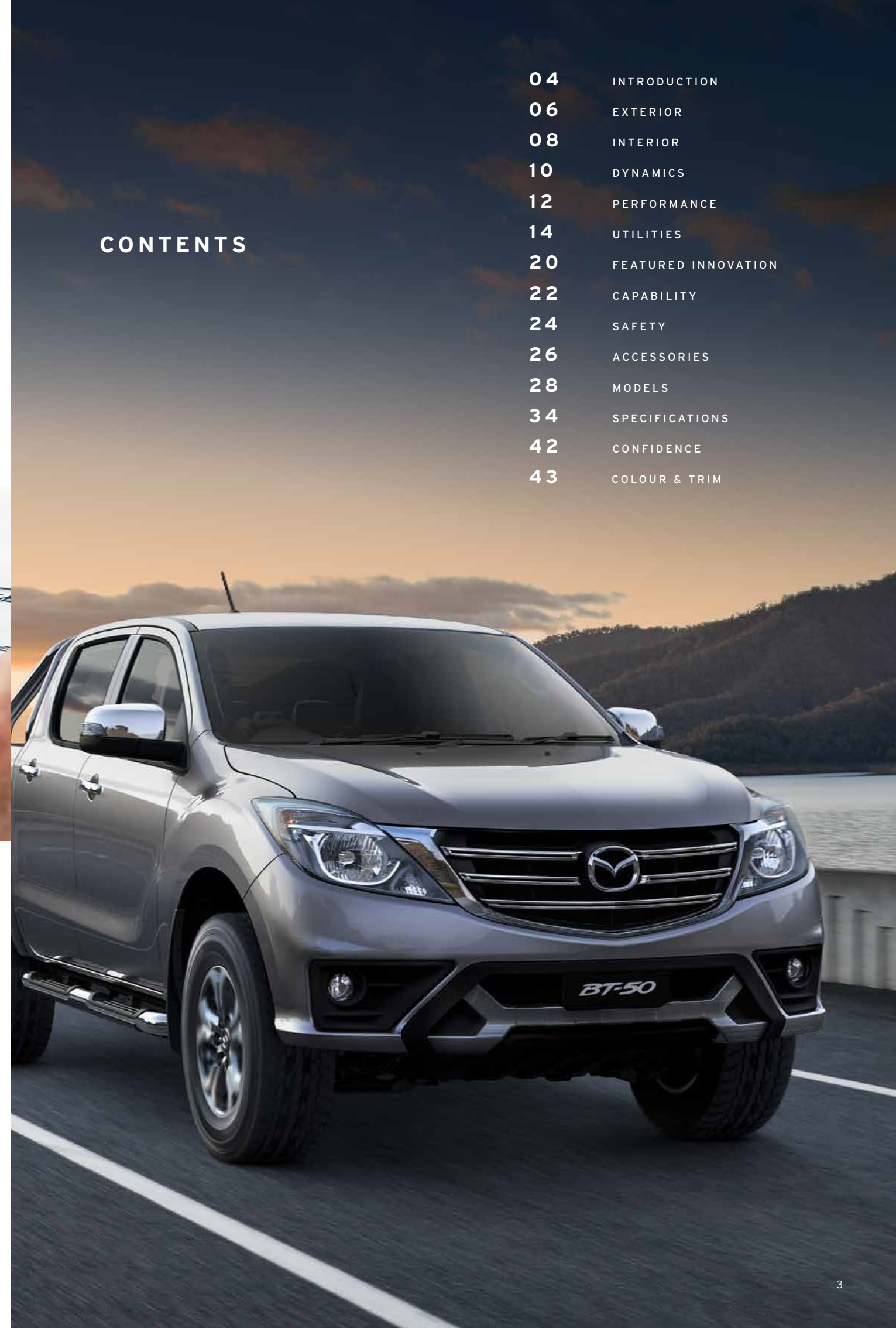



4x4 Dual Cab Utility GT in Aluminium Metallic.

BUILT LIKE A BT-50

There's no other ute that's built like a BT-50. It delivers power when you need it, and refined comfort with every drive. Fill it with gear, pull a load or take it off road. As a workhorse or a weekend warrior, it's built to rise to any challenge.

Smart connectivity, including Apple CarPlay® and Android® Auto, means Mazda BT-50 is clever as well as capable. The spacious cabin offers a level of style and passenger comfort that makes it feel more like a car. It's all protected with advanced safety features like airbags, Dynamic Stability Control and Reverse Camera.

Add to all of this a bold new look, Mazda BT-50 can do it all - with added Zoom-Zoom.



4x4 Dual Cab Utility GT in Titanium Flash Mica.



A RUGGED FACE. A HEART OF GOLD

Mazda BT-50 is built with a bold front end design. The styling visually lowers the centre of gravity toward the front, giving it a wide, stable stance and adding to the commanding street presence. You can personalise your Mazda BT-50 to suit your style too with a range of accessories and options to choose from.



4x4 Dual Cab Utility GT.

A CUT ABOVE

These days tough's not enough. That's why Mazda BT-50 is built with all the comforts you'd expect in a car. The interior is decked out with quality trims and finishes, like a luxurious leather-bound steering wheel (XTR and GT only). Stay comfortable all year round with powerful heating and cooling, including dual-zone climate control in selected models.

There's plenty of clever thinking built in too with useful driver tech like Apple CarPlay® and Android® Auto, trip computer and cruise control.

You'll also get access to Sat Nav with off-road maps on XTR and GT models as well as DAB+ digital radio, now standard on all grades, ready for you to crank up the thumping audio system. Mazda BT-50 is USB and Bluetooth® compatible, so you can make and answer phone calls with built-in hands-free connectivity[§]

[§] Please check the compatibility of your Bluetooth® device (particularly your mobile phone) with the specific Mazda vehicle you intend to purchase as not all devices operate correctly. Visit www.mazda.com.au/Bluetooth or consult your Mazda Dealer for further information.





BUILT TO PERFORM

When it comes to performance, Mazda BT-50 has it in spades. Built tough from the ground up, its ladder frame chassis provides reinforcement for maximum rigidity. The resulting stability can be felt in car-like handling - even when taking on large payloads.

Mazda BT-50's powerful engines also make towing light work, hauling boats, caravans and trailers with ease. Under the bonnet, new generation turbo diesel engines give you the power to get the job done. Harnessing the power is up to you - choose from a rugged 6-speed manual for complete control, or a versatile 6-speed auto that also allows for smooth manual changes.

BUILT FROM THE INSIDE OUT

Make the most of generous power with responsive performance. Mazda BT-50 rises to the toughest challenges with effortless grunt, thanks to advanced common-rail direct injection. A variable geometry turbocharger reduces lag on the gutsy 2.2L, delivering an effortless 110kW and 375Nm of torque. Choose the 3.2L, and you get 147kW with a whopping 470Nm.

* Combined fuel consumption figures are based on ADR 81/02 test results. They are useful in comparing the fuel consumption of different vehicles. They may not be the fuel consumption achieved in practice. This will depend on traffic, road conditions and how the vehicle is driven.



2.2L ENGINE

Boosted by a variable geometry turbocharger to reduce lag, the 2.2L engine delivers all the power you need. 4x2 Single Cab Chassis XT's four-cylinder engine gives you 110kW and 375Nm and uses 8.0L/100km* (Manual)

Black Engine cover not available on 2.2L Engine.



3.2L ENGINE

Feel the grunt of a five-cylinder engine with common-rail direct injection and intercooling. Pumping out 147kW and 470Nm of torque from 8.9 litres per 100km* (combined), you get effortless muscle for every task.

Black Engine cover on XTR and GT models only.



BODY

High-tensile steel is behind the Mazda BT-50's durable body shell. Exceptionally strong, it also keeps overall weight down.



CHASSIS

Reinforced with a rigid ladder frame chassis, Mazda BT-50 is ready to take on the heavy-duty jobs. Front wishbone suspension and rear leaf suspension cushion the ride for car-like handling on and off the road.



AUTOMATIC TRANSMISSION

Let the intelligent six-speed auto do the work for you, or step in for manual gear shifts when the mood strikes. In auto mode, Active Adaptive Shift (AAS) kicks in - intuitively changing gears to suit your driving conditions.



MANUAL TRANSMISSION

Enjoy the smooth ride of a six-speed manual that delivers fluid precision-shifting ratios. Transition through gear changes with ease for a true sense of control over your vehicle's performance.



4x4 Dual Cab Utility GT in Titanium Flash Mica fitted with optional tow bar.

CONQUER THE EARTH

Equipped with power and backbone, Mazda BT-50 has serious muscle. Don't be afraid to load it up and give it heaps - it takes on hefty towing jobs and payloads effortlessly. The rugged 4x4 is backed by the latest driver support tech meaning uneven terrain has never been easier to conquer. Jump between 2-High and 4-High at the flick of a switch, without stopping the vehicle. Operated via a console switch, electronic Locking Rear Differential (eLRD) gives you maximum traction on uneven terrain. By locking the rear differential, torque is distributed evenly between the rear wheels. If one wheel loses grip, the other continues to provide power, turning the wheel to get traction on the ground.

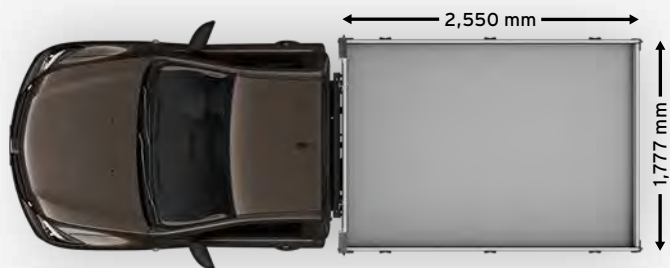

14 Single Cab

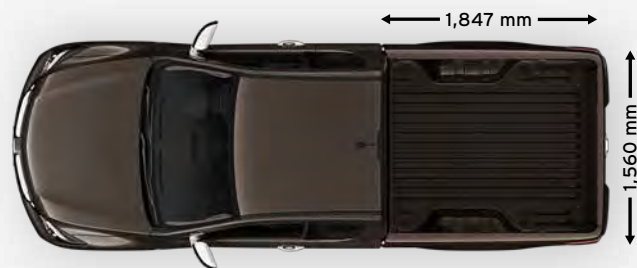

Freestyle Cab

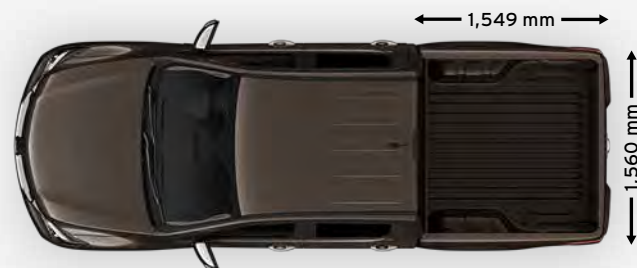

Dual Cab



4x4 Freestyle Cab Utility XTR in Blue Reflex Mica.



READY, WILLING, ABLE

Whether it's navigating new terrain, carrying heavy cargo or towing a few tonnes, Mazda BT-50 handles it all without breaking a sweat. The Freestyle Cab offers you the versatility to make room for up to 4 adult passengers, with adjustable seating configurations and clever rear door access.



4x2 Single Cab Chassis XT Lo-Rider in Cool White fitted with optional premium alloy tray and tow bar.



STRENGTH WITH AGILITY

Built like it's born to work, you get all the tech, safety and power you need from the tough Single Cab. It's ready to tow the big stuff and carry the heftiest payloads. In selected models there's room for three occupants, featuring a bucket seat for the driver and bench seating for two others. Auto models seat two in comfortable bucket seats.



4x4 Dual Cab Utility GT.



20 4x4 Dual Cab Utility XTR.



ROOM TO MOVE

Power, strength and capability - Mazda BT-50 consistently delivers. When it comes to space, it's no different. While Mazda BT-50 boasts a generous cargo box in the back, you'll be surprised how much smart storage can be found around the cabin too. Tuck your gear away in the split-level centre console space, or the sizeable glovebox that swallows a 16-inch laptop. Drinks and sunnies have their own dedicated spaces, keeping them within grabbing reach on every trip.



4x4 Dual Cab Utility GT with optional accessories.

BUILT FOR AUSTRALIA

Mazda BT-50 is ready to handle the demanding driving conditions of our rugged landscape. Challenging terrain is met with gritty performance that adapts to its environment with intelligent driver aids like Dynamic Stability Control (DSC) and Hill Descent Control (HDC). Leave no territory unexplored - be ready for any terrain with the robust 4x4. Switch between 2-High and 4-High at the flick of a console switch without even stopping the vehicle. While Australia's harsh weather extremes can make being outside unbearable, you'll always be comfortable inside with Mazda BT-50's dual-zone climate control (XTR and GT only).



CONFIDENCE BUILT-IN

In a Mazda BT-50 you're driving a vehicle that's big on safety. Driver support begins with a rigid chassis and precise handling, giving you the capacity to avoid potential hazards! In the event Mazda BT-50 does run into trouble, it's well equipped to deal with it. The reinforced body shell is fitted with front airbags and head-protecting curtain airbags in all models. Freestyle and Dual Cab models also come with the addition of side (front) airbags.

Every seat is armed with three-point lap-sash seatbelts, with Dual Cab and Freestyle Cab models featuring two child restraint anchor points in the rear.

Roll Stability Control (RSC) monitors your driving data and applies appropriate measures to help prevent rollover. When your cargo raises Mazda BT-50's centre of gravity, you've got Load Adaptive Control (LAC) for extra stability.

Dynamic Stability Control (DSC) helps keep traction in all conditions, managing the engine power and braking force delivered to individual wheels to avoid skidding or loss of grip.

ABS brakes feature Electronic Brake-force Distribution (EBD) which matches braking to vehicle load, while Emergency Brake Assist (EBA) boosts stopping power when emergency braking is sensed. An Emergency Stop Signal (ESS) activates the hazard lights to warn following drivers of sudden deceleration.

† Driver-assistance features do not replace the driver's judgement and are not to be used in place of skilled and safe driving practices. It is the driver's sole responsibility to monitor vehicle surroundings and conditions and comply with all applicable laws at all times.



4x4 Dual Cab Utility GT in Aluminium Metallic.

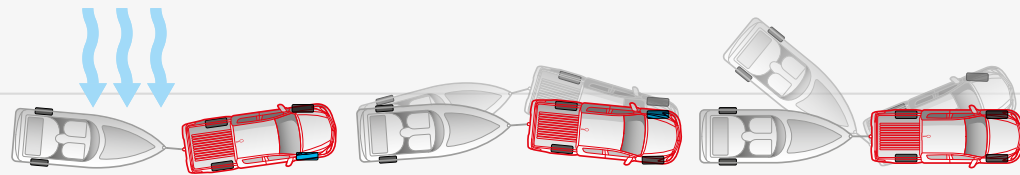

SAFETY REFLEX

Trailer Sway Control (TSC) adjusts braking and torque to correct any side-to-side swinging movement of towed loads.

BETTER BRAKING

Stopping distance with EBA, ABS and EBD.

Stopping distance with no assistance.



INCLINES MADE EASY

Remove your foot from the brake on an incline and Hill Launch Assist (HLA) keeps the brakes applied, releasing them when there's enough power for a smooth start. While you're on steep slopes, you can engage Hill Descent Control (HDC) to maintain steady control of your speed.



4x4 Dual Cab Utility GT with optional accessories.

MAKE IT YOUR OWN

Build your own Mazda BT-50 with specially designed Mazda Genuine Accessories. You can toughen up the capabilities and functionality while enhancing its rugged looks and adventurous spirit. Mazda Genuine Accessories also protect your Mazda BT-50 and add value. To discover the full suite of accessories, please refer to the Accessories Brochure, or online.



BT-50

SINGLE CAB



SINGLE CAB FEATURES

XT

- » 16-inch steel wheels
- » Headlamps (Halogen)
- » Power windows and mirrors (black)
- » Seat trim: Black cloth
- » Air-conditioning
- » Cruise control
- » Lockable glovebox
- » Trip computer
- » Audio system with: AM/FM tuner
- » 7-inch touch screen
- » DAB+ digital radio
- » Apple Carplay® and Android® Auto
- » Reverse camera
- » Bluetooth® hands-free phone and audio capability§
- » Steering wheel-mounted audio controls
- » Airbags SRS: front (driver and passenger) and curtain (driver and passenger)
- » Anti-lock Braking System (ABS)
- » Dynamic Stability Control (DSC)
- » Emergency Stop Signal (ESS)
- » Hill Launch Assist (HLA)
- » Roll Stability Control (RSC)
- » Traction Control System (TCS)
- » Trailer Sway Control (TSC)

4x2 Single Cab Chassis XT Lo-Rider in Cool White fitted with optional premium alloy tray.

POWERTRAIN

2.2 LITRE

- » 2.2 litre in-line 4 cylinder 16 valve DOHC intercooled turbo diesel engine
- » Drivetrain: 4x2 or 4x2 Hi-Rider
- » Max power: 110kW @ 3,700rpm
- » Max torque: 375Nm @ 1,500-2,500rpm
- » Fuel consumption (combined): 8.0L/100km* (4x2, man) or 8.6L/100km* (4x2 Hi-Rider, auto)

3.2 LITRE

- » 3.2 litre in-line 5 cylinder 20 valve DOHC intercooled turbo diesel engine
- » Drivetrain: 4x2 Hi-Rider or 4x4
- » Max power: 147kW @ 3,000rpm
- » Max torque: 470Nm @ 1,750-2,500rpm
- » Fuel consumption (combined): 8.9L/100km* (4x2 Hi-Rider, man) or 9.7L/100km* (4x4, man) or 10.0L/100km* (4x4, auto)

§ Please check the compatibility of your Bluetooth® device (particularly your mobile phone) with the specific Mazda vehicle you intend to purchase as not all devices operate correctly. Visit www.mazda.com.au/Bluetooth or consult your Mazda Dealer for further information.

* Combined fuel consumption figures are based on ADR 81/02 test results. They are useful in comparing the fuel consumption of different vehicles. They may not be the fuel consumption achieved in practice. This will depend on traffic, road conditions and how the vehicle is driven.



GET COMFORTABLE

The single cab features a bucket seat for the driver and bench seating for two others - all finished in durable cloth trim. Auto models seat two in comfortable bucket seats.



CONNECT FOR WORK AND PLAY

Do business or connect with the world around you with Apple CarPlay® and Android Auto available when you pair up your compatible smartphone.



SMOOTH CRUISING¹

Maintain a consistent speed and save fuel without the distraction of checking your speedometer.



HANDS-ON CONTROL

You'll never have to take your hands off the wheel with this smart control.



DON'T BACK INTO TROUBLE

The Reverse Camera now with an integrated 8-inch screen means you'll always have a clear view of what's behind you.

BT-50
FREESTYLE CAB



FREESTYLE CAB FEATURES

XT

- » 16-inch steel wheels
- » Freestyle door system
- » Rear step bumper (black) - utility only
- » Lockable tailgate - utility only
- » Headlamps (Halogen)
- » Power windows and mirrors (black)
- » Seat trim: Black cloth
- » Air-conditioning
- » Cruise control
- » Lockable glovebox
- » Trip computer
- » Audio system with: AM/FM tuner
- » 7-inch touch screen
- » DAB+ digital radio
- » Apple Carplay® and Android® Auto
- » Reverse camera
- » Bluetooth® hands-free phone and audio capability§
- » Steering wheel-mounted audio controls
- » Airbags SRS: front (driver and passenger), side (front) and curtain (front and rear)
- » Anti-lock Braking System (ABS)
- » Dynamic Stability Control (DSC)
- » Emergency Stop Signal (ESS)
- » Hill Descent Control (HDC) - 4x4 only
- » Hill Launch Assist (HLA)
- » Locking Rear Differential (LRD) - 4x4 only
- » Roll Stability Control (RSC)
- » Traction Control System (TCS)
- » Trailer Sway Control (TSC)

4x4 Freestyle Cab Utility XTR in Blue Reflex Mica.

XTR ADDITIONAL TO XT

- » 17-inch alloy wheels
- » Door handles (chrome)
- » Front fog-lamps (Halogen)
- » Headlamps auto on/off function
- » Power mirrors (chrome)
- » Rear step bumper (chrome)
- » Side steps (tubular, polished)
- » Wipers (front) 2-speed with rain-sensing function
- » Air-conditioning (dual-zone climate control)
- » Floor covering: carpet
- » Leather-wrapped steering wheel and gear shift knob
- » 8-inch touch screen
- » Audio system with: 6 speakers
- » Satellite navigation with off-road maps

POWERTRAIN

- » 3.2 litre in-line 5 cylinder 20 valve DOHC intercooled turbo diesel engine
- » Drivetrain: 4x2 Hi-Rider or 4x4
- » Max power: 147kW @ 3,000rpm
- » Max torque: 470Nm @ 1,750-2,500rpm
- » Fuel consumption (combined): 8.9L/100km* (4x2 Hi-Rider, man) or 9.3L/100km* (4x2 Hi-Rider, auto) or 9.7L/100km* (4x4, man) or 10.0L/100km* (4x4, auto)

§ Please check the compatibility of your Bluetooth® device (particularly your mobile phone) with the specific Mazda vehicle you intend to purchase as not all devices operate correctly. Visit www.mazda.com.au/Bluetooth or consult your Mazda Dealer for further information.

* Combined fuel consumption figures are based on ADR 81/02 test results. They are useful in comparing the fuel consumption of different vehicles. They may not be the fuel consumption achieved in practice. This will depend on traffic, road conditions and how the vehicle is driven.



VERSATILITY AND DURABILITY

All seats are finished in quality cloth trim, and how they're configured is up to you.



FREEDOM OF FLEXIBILITY

Open up your interior options with a versatile rear door configuration.



THE RIGHT DIRECTION

In-built navigation leads the way so you can relax and enjoy the ride. (Navigation available on XTR only.)



THE PERFECT TEMPERATURE

With dual climate control you and your passenger can both enjoy optimum cabin temperature. Even if it's not the same. (Available on XTR only.)



A BIG BOLD LOOK

These 17-inch alloys get the job done and give your Mazda BT-50 a unique, bold look and a commanding street presence. (Available on XTR only.)

BT-50 DUAL CAB



4x4 Dual Cab Utility GT in Titanium Flash Mica.

DUAL CAB FEATURES

XT

- » 16-inch alloy wheels - utility only
- » Headlamps (Halogen)
- » Power windows and mirrors (black)
- » Rear step bumper (black) - utility only
- » Lockable tailgate - utility only
- » Seat trim: Black cloth
- » Air-conditioning
- » Cruise control
- » Lockable glovebox
- » Trip computer
- » Audio system with: AM/FM tuner
- » 7-inch touch screen
- » DAB+ digital radio
- » Apple Carplay® and Android® Auto
- » Reverse camera
- » Bluetooth® hands-free phone and audio capability[§]
- » Steering wheel-mounted audio controls
- » Airbags SRS: front (driver and passenger), side (front) and curtain (front and rear)
- » Anti-lock Braking System (ABS)
- » Dynamic Stability Control (DSC)
- » Emergency Stop Signal (ESS)
- » Hill Descent Control (HDC) - 4x4 only
- » Hill Launch Assist (HLA)
- » Locking Rear Differential (LRD) - 4x4 only
- » Roll Stability Control (RSC)
- » Traction Control System (TCS)
- » Trailer Sway Control (TSC)
- » Tailgate lock

XTR ADDITIONAL TO XT

- » 17 inch alloy wheels
- » Door handles (chrome)
- » Front fog-lamps (Halogen)
- » Headlamps auto on/off function
- » Power mirrors (chrome)
- » Rear step bumper (chrome)
- » Side steps (tubular, polished)
- » Wipers (front) 2-speed with rain-sensing function

- » Air-conditioning (dual-zone climate control)
- » Floor covering: carpet
- » Leather-wrapped steering wheel and gear shift knob
- » Rear-view mirror auto dimming
- » 8-inch touch screen
- » Satellite navigation with off-road maps

GT ADDITIONAL TO XTR

- » Power mirrors (heating and folding function) with turn indicator
- » Privacy glass
- » Front seats with: 8-way power adjustment (driver)
- » Seat trim: Black leather[#]
- » Sports bar
- » Tub liner
- » Remote tailgate lock
- » 12V socket and light in cargo box

POWERTRAIN

- » 3.2 litre in-line 5 cylinder 20 valve DOHC intercooled turbo diesel engine
- » Drivetrain: 4x2 Hi-Rider or 4x4
- » Max power: 147kW @ 3,000rpm
- » Max torque: 470Nm @ 1,750-2,500rpm
- » Fuel consumption (combined): 8.9L/100km* (4x2 Hi-Rider, man) or 9.3L/100km* (4x2 Hi-Rider, auto) or 9.7L/100km* (4x4, man) or 10.0L/100km* (4x4, auto)

[§] Please check the compatibility of your Bluetooth® device (particularly your mobile phone) with the specific Mazda vehicle you intend to purchase as not all devices operate correctly. Visit www.mazda.com.au/Bluetooth or consult your Mazda Dealer for further information.

[#] Leather interior includes some Maztex material on selected high impact surfaces.

* Combined fuel consumption figures are based on ADR 81/02 test results. They are useful in comparing the fuel consumption of different vehicles. They may not be the fuel consumption achieved in practice. This will depend on traffic, road conditions and how the vehicle is driven.



SPACE AND STYLE

Accommodate five adults comfortably in black cloth seating, or select indulgent black leather.*

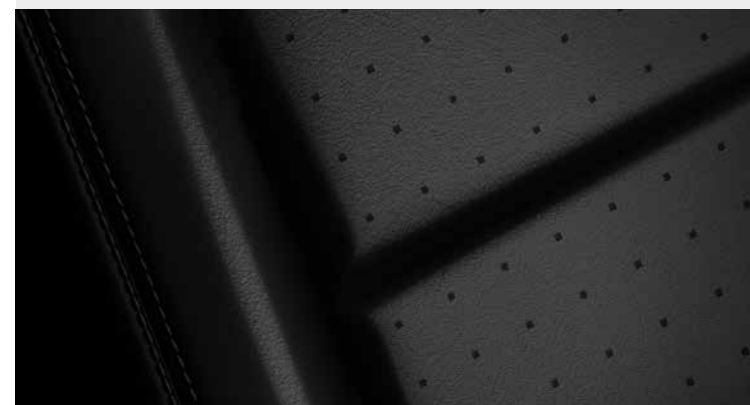

GET COMFORTABLE

Inviting leather[#] seats feature 8-way power adjustment for maximum driver comfort. (GT only)



RAISE THE BAR

This great looking sports bar adds a new level of toughness and helps keep your load secure.



KEEP IT PROTECTED

The durable tub liner is highly resistant to UV light and withstands exposure to chemicals like paint and fuel. (GT only)



12V SOCKET

With 2 in-built 15-amp sockets you can power your appliances and tools. Features smart circuit, battery protection and touch light. (GT only)

SPECIFICATIONS

4x2

		2.2L Single Cab Chassis XT	2.2L Single Cab Chassis XT Hi-Rider	3.2L Single Cab Chassis XT Hi-Rider	3.2L Freestyle Cab Chassis XT Hi-Rider	3.2L Dual Cab Chassis XT Hi-Rider	3.2L Dual Cab Utility XT Hi-Rider	3.2L Dual Cab Utility XTR Hi-Rider	
Powertrain		3.2 litre in-line 5 cylinder 20 valve DOHC intercooled turbo diesel							
Engine type		2.2 litre in-line 4 cylinder 16 valve DOHC intercooled turbo diesel							
Engine capacity		2,198 cc		3,198 cc					
Bore and stroke		86.0 mm x 94.6 mm		89.0 mm x 100.7 mm					
Compression ratio		15.5 : 1		15.5 : 1					
Maximum power		110 kW @ 3,700 rpm		147 kW @ 3,000 rpm					
Maximum torque		375 Nm @ 1,500 - 2,500 rpm		470 Nm @ 1,750 - 2,500 rpm					
Throttle control		Electronic (drive-by-wire)		Electronic (drive-by-wire)					
Fuel system		Common-rail, electronic direct injection		Common-rail, electronic direct injection					
Fuel tank capacity		80 litres		80 litres					
Recommended fuel		Diesel		Diesel					
Fuel consumption*	man (combined)	8.0 litres per 100 km	-	8.9 litres per 100 km					
	auto (combined)	-	8.6 litres per 100 km	9.3 litres per 100 km					
Emissions standard		Euro stage V		Euro stage V					
Alternator		12 volts - 110 amps		12 volts - 110 amps					
Manual transmission		6-speed	-	6-speed					
Automatic transmission		-	6-speed	-	6-speed				
Gear ratio - man/auto	1st	5.441 / -	- / 4.171	5.441 / -	5.441 / 4.171				
	2nd	2.839 / -	- / 2.342	2.839 / -	2.839 / 2.342				
	3rd	1.721 / -	- / 1.521	1.721 / -	1.721 / 1.521				
	4th	1.223 / -	- / 1.143	1.223 / -	1.223 / 1.143				
	5th	1.000 / -	- / 0.867	1.000 / -	1.000 / 0.867				
	6th	0.794 / -	- / 0.691	0.794 / -	0.794 / 0.691				
	reverse	4.935 / -	- / 3.403	4.935 / -	4.935 / 3.403				
	final drive	3.310 / -	- / 3.550	3.550 / -	3.550 / 3.730				

Weights and capacities

Axle capacity	front	1,324 kg	1,480 kg	1,480 kg	1,480 kg	1,480 kg	1,480 kg	1,480 kg
	rear	1,752 kg	1,850 kg	1,850 kg	1,850 kg	1,850 kg	1,850 kg	1,850 kg
Gross Combined Mass (GCM) [∞]	man	5,425 kg	-	6,000 kg	6,000 kg	6,000 kg	6,000 kg	6,000 kg
	auto	-	6,000 kg	-	6,000 kg	6,000 kg	6,000 kg	6,000 kg
Gross Vehicle Mass (GVM) [‡]	man	2,925 kg	-	3,200 kg	3,200 kg	3,200 kg	3,200 kg	3,200 kg
	auto	-	3,200 kg	-	3,200 kg	3,200 kg	3,200 kg	3,200 kg
Kerb weight [⌈]	man	1,622 kg	-	1,695 kg	1,773 kg	1,832 kg	1,922 kg	1,988 kg
	auto	-	1,667 kg	-	1,798 kg	1,849 kg	1,939 kg	2,005 kg
Kerb weight when fitted with Mazda Standard Alloy Tray [⌈]	man	1,765 kg	-	1,839 kg	1,898 kg	1,946 kg	-	-
	auto	-	1,811 kg	-	1,923 kg	1,963 kg	-	-
Payload [≈]	man	1,303 kg	-	1,505 kg	1,427 kg	1,368 kg	1,278 kg	1,212 kg
	auto	-	1,533 kg	-	1,402 kg	1,351 kg	1,261 kg	1,195 kg
Payload when fitted with Mazda Standard Alloy Tray [≈]	man	1,160 kg	-	1,361 kg	1,302 kg	1,254 kg	-	-
	auto	-	1,389 kg	-	1,277 kg	1,237 kg	-	-
Seating capacity	man	3	-	3	4	5	5	5
	auto	-	2	-	4	5	5	5
Tow ball download [⌘]	maximum	250 kg	350 kg	350 kg	350 kg	350 kg	350 kg	350 kg
Towing capacity [⌘]	braked	2,500 kg	3,500 kg	3,500 kg	3,500 kg	3,500 kg	3,500 kg	3,500 kg
	unbraked	750 kg	750 kg	750 kg	750 kg	750 kg	750 kg	750 kg

- = Not available.

* Combined fuel consumption figures are based on ADR 81/02 test results. They are useful in comparing the fuel consumption of different vehicles. They may not be the fuel consumption achieved in practice. This will depend on traffic, road conditions and how the vehicle is driven.

∞ Gross Combined Mass (GCM) is the total permissible combined weight of the vehicle and trailer/caravan being towed including occupants, fuel and cargo.

‡ Gross Vehicle Mass (GVM) is the total permissible weight of the vehicle including occupants, fuel and cargo.

⌈ Kerb Weight is the unladen weight of the vehicle including all fluids and a full tank of fuel.

≈ Maximum payload weight is calculated as the difference between GVM and Kerb weight. The weight of any vehicle occupants, options, accessories, modifications, cargo and tow ball download must be included when calculating payload weight.

⌘ When fitted with a Mazda Genuine Towing kit. Subject to State and Territory regulations.

4x4

		3.2L Single Cab Chassis XT	3.2L Freestyle Cab Chassis XT	3.2L Freestyle Cab Utility XTR	3.2L Dual Cab Chassis XT	3.2L Dual Cab Utility XT	3.2L Dual Cab Utility XTR	3.2L Dual Cab Utility GT
Powertrain		3.2 litre in-line 5 cylinder 20 valve DOHC intercooled turbo diesel						
Engine type		3.2 litre in-line 5 cylinder 20 valve DOHC intercooled turbo diesel						
Engine capacity		3,198 cc						
Bore and stroke		89.0 mm x 100.7 mm						
Compression ratio		15.5 : 1						
Maximum power		147 kW @ 3,000 rpm						
Maximum torque		470 Nm @ 1,750 - 2,500 rpm						
Throttle control		Electronic (drive-by-wire)						
Fuel system		Common-rail, electronic direct injection						
Fuel tank capacity		80 litres						
Recommended fuel		Diesel						
Fuel consumption*	man (combined)	9.7 litres per 100 km						
	auto (combined)	10.0 litres per 100 km						
Emissions standard		Euro stage V						
Alternator		12 volts - 110 amps						
Manual transmission		6-speed						
Automatic transmission		6-speed						
Gear ratio - man/auto	1st	5.441 / 4.171						
	2nd	2.839 / 2.342						
	3rd	1.721 / 1.521						
	4th	1.223 / 1.143						
	5th	1.000 / 0.867						
	6th	0.794 / 0.691						
	reverse	4.935 / 3.403						
	final drive	3.550 / 3.730						
Transfer gear	high	1.000						
	low	2.718						

Weights and capacities

Axle capacity	front	1,480 kg	1,480 kg	1,480 kg	1,480 kg	1,480 kg	1,480 kg	1,480 kg
	rear	1,850 kg	1,850 kg	1,850 kg	1,850 kg	1,850 kg	1,850 kg	1,850 kg
Gross Combined Mass (GCM) [∞]	man	6,000 kg	6,000 kg	6,000 kg	6,000 kg	6,000 kg	6,000 kg	6,000 kg
	auto	6,000 kg	6,000 kg	6,000 kg	6,000 kg	6,000 kg	6,000 kg	6,000 kg
Gross Vehicle Mass (GVM) [‡]	man	3,200 kg	3,200 kg	3,200 kg	3,200 kg	3,200 kg	3,200 kg	3,200 kg
	auto	3,200 kg	3,200 kg	3,200 kg	3,200 kg	3,200 kg	3,200 kg	3,200 kg
Kerb weight [⌈]	man	1,792 kg	1,860 kg	2,042 kg	1,932 kg	2,022 kg	2,091 kg	2,147 kg
	auto	1,820 kg	1,885 kg	2,056 kg	1,946 kg	2,036 kg	2,105 kg	2,161 kg
Kerb weight when fitted with Mazda Standard Alloy Tray [⌈]	man	1,936 kg	1,985 kg	-	2,046 kg	-	-	-
	auto	1,964 kg	2,010 kg	-	2,060 kg	-	-	-
Payload [≈]	man	1,408 kg	1,340 kg	1,158 kg	1,268 kg	1,178 kg	1,109 kg	1,053 kg
	auto	1,380 kg	1,315 kg	1,144 kg	1,254 kg	1,164 kg	1,095 kg	1,039 kg
Payload when fitted with Mazda Standard Alloy Tray [≈]	man	1,264 kg	1,215 kg	-	1,154 kg	-	-	-
	auto	1,236 kg	1,190 kg	-	1,140 kg	-	-	-
Seating capacity	man	3	4	4	5	5	5	5
	auto	2	4	4	5	5	5	5
Tow ball download [⌘]	maximum	350 kg	350 kg	350 kg	350 kg	350 kg	350 kg	350 kg
Towing capacity [⌘]	braked	3,500 kg	3,500 kg	3,500 kg	3,500 kg	3,500 kg	3,500 kg	3,500 kg
	unbraked	750 kg	750 kg	750 kg	750 kg	750 kg	750 kg	750 kg

- = Not available.

SPECIFICATIONS

4x2

		A 2.2L Single Cab Chassis XT	B 2.2L Single Cab Chassis XT Hi-Rider	C 3.2L Single Cab Chassis XT Hi-Rider	D 3.2L Freestyle Cab Chassis XT Hi-Rider	E 3.2L Dual Cab Chassis XT Hi-Rider	F 3.2L Dual Cab Utility XT Hi-Rider	G 3.2L Dual Cab Utility XTR Hi-Rider
Chassis								
Brake diameter	front	302 mm						
	rear	270 mm						
Brake type	front	Ventilated disc						
	rear	Drum						
Steering type		Rack and pinion hydraulic power assist steering						
Suspension type	front	Independent double wishbone with coil over dampers and anti-roll bar						
	rear	Rigid (live) rear axle with leaf springs						
Turning circle	kerb to kerb	11.8 m	12.4 m	12.4 m	12.4 m	12.4 m	12.4 m	12.4 m
Tyre size		215/70 R16C	255/70 R16	255/70 R16	255/70 R16	255/70 R16	255/70 R16	265/65 R17
Tyre index		106/108S	111T	111T	111T	111T	111T	112T
Wheel size		16 x 6.5 J	16 x 7.0 J	16 x 7.0 J	16 x 7.0 J	16 x 7.0 J	16 x 7.0 J	17 x 8.0 J
Wheel type		Steel	Steel	Steel	Steel	Alloy	Alloy	Alloy
Wheel size (spare)		16 x 6.5 J	16 x 7.0 J	16 x 7.0 J	16 x 7.0 J	16 x 7.0 J	16 x 7.0 J	17 x 7.5 J
Wheel type (spare)		Steel	Steel	Steel	Steel	Steel	Steel	Steel

		A	B	C	D	E	F	G
Dimensions								
Cargo box floor height to ground		-	-	-	-	-	835 mm	841 mm
Cargo box floor length		-	-	-	-	-	1,549 mm	1,549 mm
Cargo box floor width		-	-	-	-	-	1,560 mm	1,560 mm
Cargo box height		-	-	-	-	-	513 mm	513 mm
Cargo box tailgate opening width		-	-	-	-	-	1,330 mm	1,330 mm
Cargo box top length		-	-	-	-	-	1,485 mm	1,485 mm
Cargo box top width		-	-	-	-	-	1,500 mm	1,500 mm
Cargo box width between wheel arches		-	-	-	-	-	1,139 mm	1,139 mm
Ground clearance	laden	135 mm	200 mm	200 mm	200 mm	200 mm	200 mm	205 mm
	unladen	201 mm	232 mm	232 mm	232 mm	232 mm	232 mm	237 mm
Overall height		1,703 mm	1,800 mm	1,800 mm	1,804 mm	1,815 mm	1,815 mm	1,821 mm
Overall length		5,124 mm	5,124 mm	5,124 mm	5,124 mm	5,124 mm	5,373 mm	5,365 mm
Overall width		1,850 mm	1,850 mm	1,850 mm	1,850 mm	1,850 mm	1,850 mm	1,850 mm
Overhang	front	919 mm	919 mm	919 mm	919 mm	919 mm	919 mm	919 mm
	rear	985 mm	985 mm	985 mm	985 mm	985 mm	1,234 mm	1,226 mm
Track	front	1,590 mm	1,560 mm	1,560 mm	1,560 mm	1,560 mm	1,560 mm	1,560 mm
	rear	1,590 mm	1,560 mm	1,560 mm	1,560 mm	1,560 mm	1,560 mm	1,560 mm
Wading depth		600 mm	800 mm	800 mm	800 mm	800 mm	800 mm	800 mm
Wheelbase		3,220 mm	3,220 mm	3,220 mm	3,220 mm	3,220 mm	3,220 mm	3,220 mm
Approach angle		22.0°	27.6°	27.6°	27.6°	27.6°	27.6°	28.2°
Departure angle		24.0°	28.4°	28.4°	28.4°	28.4°	27.1°	26.4°
Ramp breakover angle		17.0°	24.4°	24.4°	24.4°	24.4°	24.4°	25.0°

-- Not available.

Cab chassis

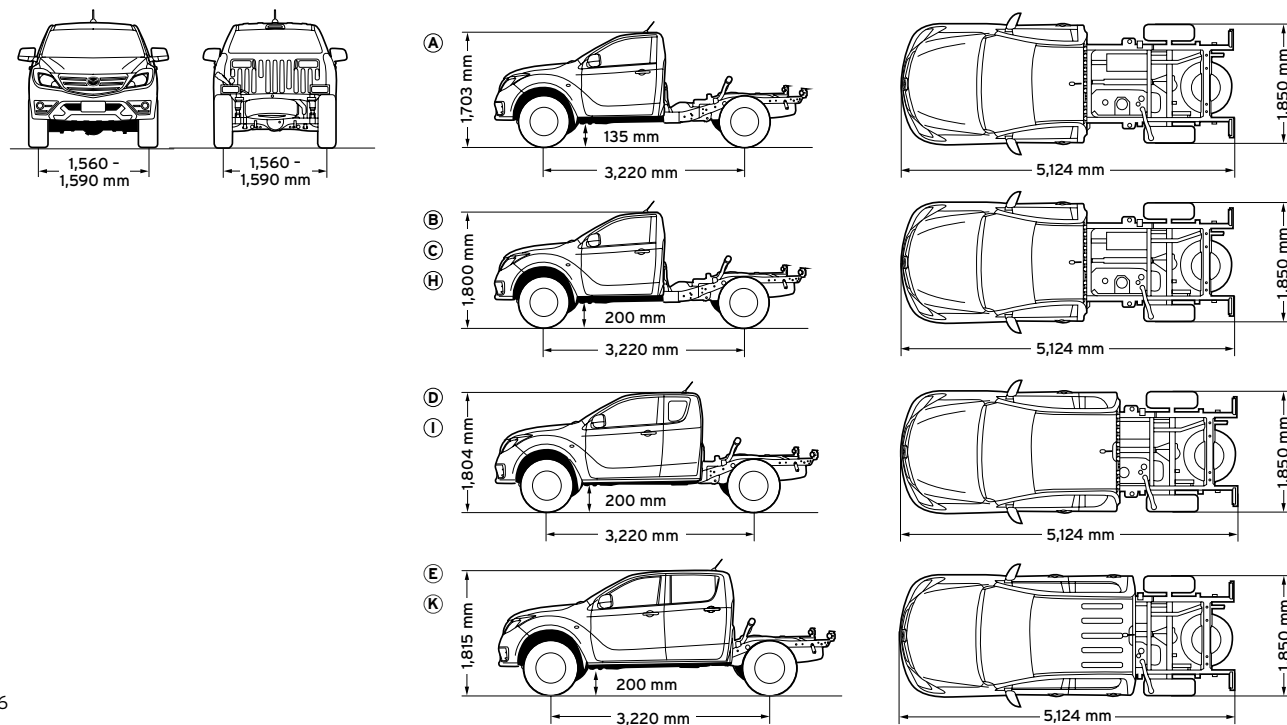

4x4

		H 3.2L Single Cab Chassis XT	I 3.2L Freestyle Cab Chassis XT	J 3.2L Freestyle Cab Utility XTR	K 3.2L Dual Cab Chassis XT	L 3.2L Dual Cab Utility XT	M 3.2L Dual Cab Utility XTR	N 3.2L Dual Cab Utility GT
Chassis								
Brake diameter	front	302 mm						
	rear	295 mm						
Brake type	front	Ventilated disc						
	rear	Drum						
Steering type		Rack and pinion hydraulic power assist steering						
Suspension type	front	Independent double wishbone with coil over dampers and anti-roll bar						
	rear	Rigid (live) rear axle with leaf springs						
Turning circle	kerb to kerb	12.4 m						
Tyre size		255/70 R16	255/70 R16	265/65 R17	255/70 R16	255/70 R16	265/65 R17	265/65 R17
Tyre index		111T	111T	112T	111T	111T	112T	112T
Wheel size		16 x 7.0 J	16 x 7.0 J	17 x 8.0 J	16 x 7.0 J	16 x 7.0 J	17 x 8.0 J	17 x 8.0 J
Wheel type		Steel	Steel	Alloy	Steel	Alloy	Alloy	Alloy
Wheel size (spare)		16 x 7.0 J	16 x 7.0 J	17 x 7.5 J	16 x 7.0 J	16 x 7.0 J	17 x 7.5 J	17 x 7.5 J
Wheel type (spare)		Steel	Steel	Steel	Steel	Steel	Steel	Steel

		H	I	J	K	L	M	N
Dimensions								
Cargo box floor height to ground		-	-	841 mm	-	835 mm	841 mm	841 mm
Cargo box floor length		-	-	1,847 mm	-	1,549 mm	1,549 mm	1,549 mm
Cargo box floor width		-	-	1,560 mm	-	1,560 mm	1,560 mm	1,560 mm
Cargo box height		-	-	513 mm	-	513 mm	513 mm	513 mm
Cargo box tailgate opening width		-	-	1,330 mm	-	1,330 mm	1,330 mm	1,330 mm
Cargo box top length		-	-	1,783 mm	-	1,485 mm	1,485 mm	1,485 mm
Cargo box top width		-	-	1,500 mm	-	1,500 mm	1,500 mm	1,500 mm
Cargo box width between wheel arches		-	-	1,139 mm	-	1,139 mm	1,139 mm	1,139 mm
Ground clearance	laden	200 mm	200 mm	205 mm	200 mm	200 mm	205 mm	205 mm
	unladen	232 mm	232 mm	237 mm	232 mm	232 mm	237 mm	237 mm
Overall height		1,800 mm	1,804 mm	1,810 mm	1,815 mm	1,815 mm	1,821 mm	1,821 mm
Overall length		5,124 mm	5,124 mm	5,365 mm	5,124 mm	5,373 mm	5,365 mm	5,365 mm
Overall width		1,850 mm	1,850 mm	1,850 mm	1,850 mm	1,850 mm	1,850 mm	1,850 mm
Overhang	front	919 mm	919 mm	919 mm	919 mm	919 mm	919 mm	919 mm
	rear	985 mm	985 mm	1,226 mm	985 mm	1,234 mm	1,226 mm	1,226 mm
Track	front	1,560 mm	1,560 mm	1,560 mm	1,560 mm	1,560 mm	1,560 mm	1,560 mm
	rear	1,560 mm	1,560 mm	1,560 mm	1,560 mm	1,560 mm	1,560 mm	1,560 mm
Wading depth		800 mm	800 mm	800 mm	800 mm	800 mm	800 mm	800 mm
Wheelbase		3,220 mm	3,220 mm	3,220 mm	3,220 mm	3,220 mm	3,220 mm	3,220 mm
Approach angle		27.6°	27.6°	28.2°	27.6°	27.6°	28.2°	28.2°
Departure angle		28.4°	28.4°	26.4°	28.4°	27.1°	26.4°	26.4°
Ramp breakover angle		24.4°	24.4°	25.0°	24.4°	24.4°	25.0°	25.0°

-- Not available.

Utility

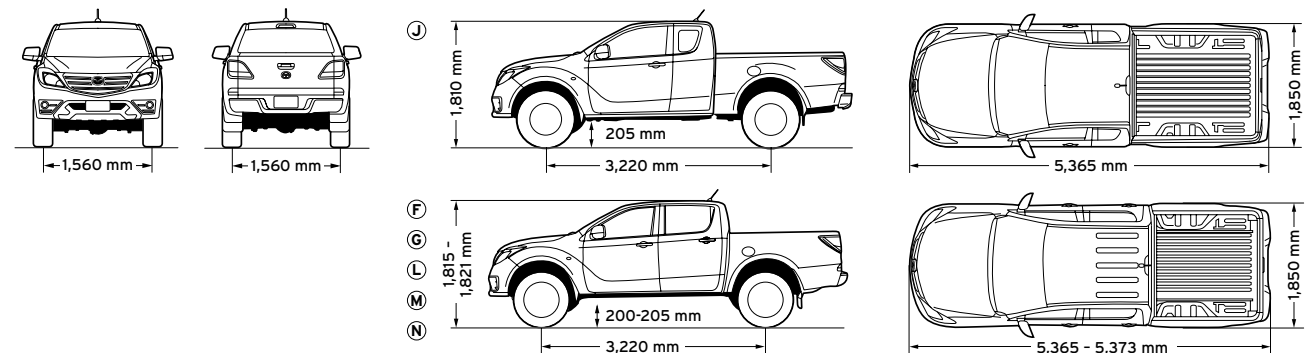

ENJOY MAZDA BT-50 WITH CONFIDENCE



REST ASSURED – YOUR WARRANTY

The quality built into Mazda BT-50 is backed up by a 5 year, unlimited kilometre factory warranty and 6 year panel protection warranty.*



MAZDA BT-50 FOR YOUR BUSINESS

The Mazda BT-50 Fleet program offers tailored deals for businesses of any size. Contact your local Dealer for more information.



MAINTAIN THAT ZOOM-ZOOM

Your Mazda BT-50 deserves the best in care. Servicing with Mazda Service Select gives your vehicle the advantage of factory-trained Service Technicians and advanced computer diagnostic systems. As well as maintaining your Mazda in A1 condition, you'll also be protecting your vehicle's outstanding resale value.

HELP IS AT HAND – MAZDA ROADSIDE ASSISTANCE

Flat batteries, running out of fuel, flat tyres – everyone faces hiccups from time to time. When the unexpected happens, Mazda Roadside Assistance is there to keep you moving. You'll be covered 24 hours a day, 365 days a year, all around Australia. Better still, your Mazda will only be worked on by Mazda-approved technicians. Choose a Standard policy offering everything needed to get going again, or Premium with extras like accommodation, a rental car and vehicle recovery. Either can be purchased across the entire Mazda range. (Terms and conditions apply.)

* New 5 year unlimited kilometre warranty available on all brand new vehicles purchased from 1 August 2018. For full terms and conditions please visit <https://www.mazda.com.au/owners/warranty/>

MAZDA BT-50 COLOUR AND TRIM

BODY COLOURS



Cool White



Aluminium Metallic

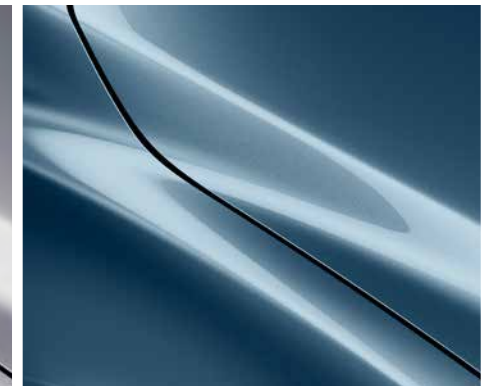

Blue Reflex Mica



Titanium Flash Mica



Deep Crystal Blue Mica



Jet Black Mica

INTERIOR TRIMS

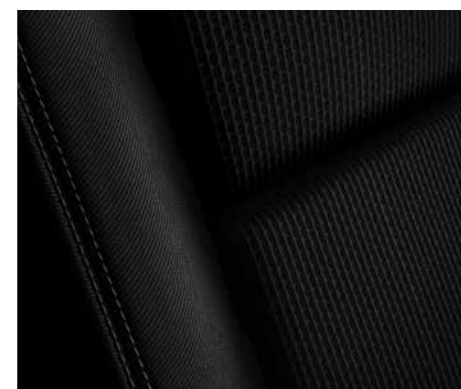

Black cloth (XT)

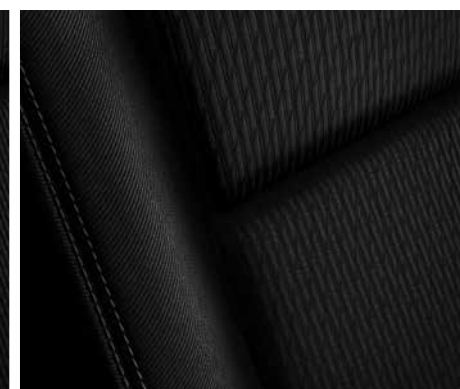

Black cloth (XTR)



Black leather# (GT)

Leather interior includes some Maztex material on selected high impact surfaces.

All care is taken to ensure the accuracy of this brochure and availability of vehicles and features at the time of publication, however, to the extent permitted by law, Mazda Australia Pty Ltd will not be liable for any loss suffered or incurred by a purchaser or prospective purchaser if the content is inaccurate or not up to date, or if it withdraws any vehicles or features referred to in the brochure from the market. Specifications, features and model availability may vary from State to State and may change without notice. Please refer to mazda.com.au or consult your Mazda Dealer prior to placing an order to ascertain current information on model availability, specifications, options, features and prices. Mazda Australia Pty Ltd ABN 78 004 690 804. 211A Wellington Road, Mulgrave, Victoria 3170. iPod is a trademark of Apple Inc., registered in the U.S. and other countries. Due to the nature of the printing process, colours may vary from those shown in this brochure. Ask your Dealer to show you a product sample.

IMAGINATION DRIVES US



Facebook.com/
MazdaAus



YouTube.com/
ZoomZoom



Twitter.com/
MazdaAus



Instagram.com/
MazdaAus

Published December 2018. MAZ13975 129.631

For further information visit mazda.com.au or Freecall 1800 034 411

**MAZDA
GENUINE
ACCESSORIES**

BT-50



zoom-zoom



BOSS ADVENTURE PACK

Be adventurous with your BT-50 and protect it with these tough and stylish accessories. Mazda Bull Bars are fully airbag compatible, ensuring safety and durability on those long drives.

- Black sports bar
- Black steel bull bar
- Black tubular side steps
- Lightforce driving lights
- Soft tonneau cover
- 17-inch 8-spoke black alloy wheels



4x4 Dual Cab Utility GT fitted with Boss Adventure Pack.

MAKE YOUR MAZDA EVEN MORE REWARDING

The powerful Mazda BT-50 can take you on any adventure. Combining durability with superior passenger comfort, it's now even more impressive, with a refreshed exterior for a tough new look. Personalise and protect your BT-50 with Mazda Genuine Accessories that deliver superb design, quality and safety, all backed by a Genuine Mazda Warranty. Mazda Genuine Accessories give you even more Zoom-Zoom.

BOSS SPORTS PACK

Prepare your BT-50 for some serious off-road fun and don't be afraid to go hard with tough-looking gear that guards against damage.

- Hard tonneau cover
- Lightforce driving lights
- Polished alloy bull bar
- Polished sports bar
- 17-inch 5-spoke alloy wheels



BOSS TOURING PACK

These tough and stylish accessories will make you want to hit the road more often.

- Canopy
- Electronic brake controller
- Lightforce driving lights
- Polished nudge bar
- Tow bar kit



4x4 Dual Cab Utility GT fitted with Boss Touring Pack.



HARD TONNEAU COVER

Keep your cargo secure with the lockable protection of a durable hard tonneau cover. Available exclusively for utilities, with or without sports bar fitted.



BLACK SPORTS BAR & SOFT TONNEAU COVER

Add sports appeal and keep your BT-50's load compartment secure with this durable soft tonneau cover and black sports bar. Available exclusively for utilities. Polished sports bar also available.



POLISHED LADDER RACK FOR SPORTS BAR

Transport ladders and other long items securely with a rack that's made for the job. Holds up to 75kg. Also available in black. (Utilities only)



BLACK NUDGE BAR

Enhances the look of your BT-50 while adding extra protection. Features mounting for optional Lightforce driving lights.



POLISHED NUDGE BAR

Toughen up the front of your BT-50. Offers extra protection and incorporates mounts for optional Lightforce driving lights.



FRONT PARKING SENSORS

Manoeuvre your BT-50 into tight spaces with front sensors that give you audible guidance.



REVERSE PARKING SENSORS

Park your BT-50 with ease with this four-sensor system. A warning tone helps prevent bumper damage by alerting you to obstacles. (Utilities only)



SNORKEL

Allows the engine to breathe in dusty conditions or through water crossings.



FENDER FLARES

Protect your BT-50's bodywork from rocks and road debris while drawing attention to its impressive wheel arches. Fender flares are available in matte black or body colour. (Front only or front and rear available)

FINKE PACK

You'll rule the road (and off road) with this sleek pack that's built as tough as it looks.

- Black steel bull bar
- Black sports bar
- Soft tonneau cover
- BT-50 decal
- 17-inch Gloss black with silver face alloy wheels



4x4 Dual Cab Utility XTR fitted with Finke Pack.



CANOPY

Cover your gear securely with this spacious canopy made from tough ABS plastic. Complete with a lockable rear door that lifts for easy access. Available with 3 window variations. (Dual Cab Utilities only)



CAB CHASSIS TRAY MAT

Protect the surface of your BT-50's tray with this tailor-made non-slip mat. (Single Cab Chassis only)



RETRACTABLE BLACK TONNEAU COVER

Made from durable aluminium, this easily-accessible tonneau cover has multiple locking positions and can be operated with the pull strap. (Dual Cab Utilities only)



CANOPY ROOF RACKS

Increase your carrying capacity up to an extra 150kgs with these durable, light and aerodynamic canopy roof racks.



SLIMLINE ROOF RAILS FOR CANOPY

Carry more with these sleek, but durable BT-50 Slimline Canopy Roof Rails with a load capacity of 75kgs.



UTILITY TRAY MAT WITH TUB ILLUMINATION

A protective non-slip surface for your tray with handy lighting embedded into the tub's lip. (Utilities only)



TUB AND TAILGATE LINER

Surface protection tailored to your BT-50. This durable liner is highly resistant to UV light and withstands exposure to chemicals like paint and fuel. (Utilities only)



DUAL BATTERY KIT

Run powerful electrical equipment from this unit without the risk of draining your BT-50's main battery. Fitted with one standard 12V and one Merit socket. (Utilities only)



DOUBLE 12-VOLT AUXILIARY SOCKET

Power electrical appliances with two in-built, 15-amp sockets with smart circuit, battery protection and handy touch light. Fitted with one standard 12V and one Merit socket.



MATTE BLACK BONNET PROTECTOR
Keep your paintwork safe from chips and dents.



RUBBER FLOOR MATS
Heavy-duty mats custom-made for complete coverage.



CARPET FLOOR MATS
Customised mats to prolong the life of your carpets. These durable mats include a heel pad for the driver's side.



FRONT SEAT COVERS
Keep your front seats grime-free with these durable, customised covers. Made from waterproof neoprene, they're fully airbag compatible.



REAR SEAT COVER
Prolong the life of your rear seats with this lightweight, waterproof cover. Shields from dirt, spills, pets and everyday wear and tear. (Dual Cab only)



CLEAR BONNET PROTECTOR
Protect your BT-50's bonnet from costly damage.



HEADLIGHT PROTECTORS
Protect your BT-50's headlamps from damage caused by road debris.



MOBILE PHONE HOLDER
Safe, stylish and compatible with many phones, this holder gives drivers easy phone visibility and access. Allows for portrait and landscape use.

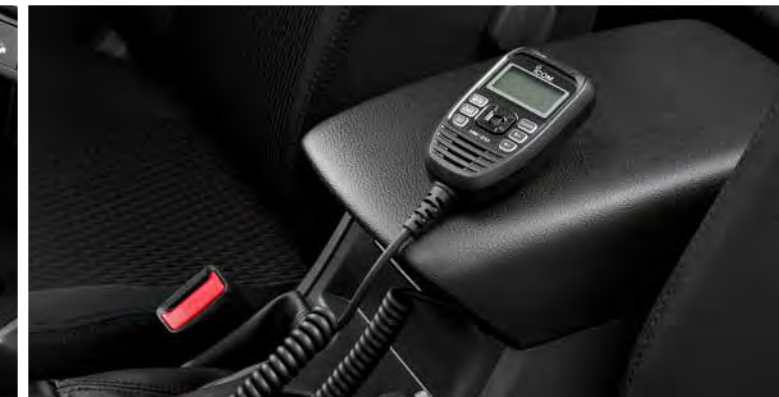

UHF RADIO
Stay connected and safe in remote areas with this reliable 80 channel UHF radio unit.



WEATHERSHIELDS
Made from UV-resistant acrylic, weathershields let fresh air in while keeping the elements out. (Front only)



SLIMLINE WEATHERSHIELDS
Allow fresh air into the cabin whatever the weather, allowing heat to escape and preventing windows from fogging. (Set of two or four)



SCUFF PLATES
Protect door sills from scratching and scuffs with this stylish addition to your BT-50.



SAFETY PACK
Attract attention in an emergency situation and warn of hazards with this safety kit featuring lights, reflective vest and triangular road sign.



STANDARD MAZDA ALLOY TRAY

This tough alloy tray comes equipped with an angled headboard, 255mm medium-duty drop sides, internal load restraint rails and rope rails. It also features Mazda-branded tailgate decals and mudguards. Available on Single Cab, Freestyle Cab and Dual Cab Chassis models.



PREMIUM MAZDA ALLOY TRAY

Features additional to the Standard Alloy Tray include a tubular headboard, tail light protector, wiring guards, tubular ladder rack, 23L water tank, slimline toolbox and rear window protector. Available on Single Cab, Freestyle Cab and Dual Cab Chassis models.



TAILGATE DUST SEAL

Fits to the inside of your BT-50's tailgate to restrict the entry of dust and water.



TOW BAR

A custom tow bar made specifically to accommodate the BT-50's impressive braked towing capacity of 3,500kg and 350kg maximum tow ball download (Hi-Rider models only), or 2,500kg braked towing capacity and a 250kg maximum tow ball download* (2.2L manual model only).



ELECTRONIC BRAKE CONTROLLER AND TRAILER BREAK-AWAY HARNESS

Electronic brakes seamlessly integrates with your BT-50's braking system to help control your trailers electronic brakes. The Trailer Break-Away Harness supplies power to the trailer breakaway system on the trailer should it come free from your BT-50.

ALSO AVAILABLE:

- | | |
|---|---|
| Audio retractable Lightning cable | 12V single smart socket |
| Audio retractable Micro USB cable | Soft tonneau cover (Freestyle models) |
| Audio retractable port C cable | Tailgate central locking |
| Black or polished tubular side steps (Freestyle models) | Tow ball |
| Boss Tray kit | Tow ball cover |
| Dual battery kit (for tub and tailgate liners and Cab Chassis models) | Trailer wiring harness |
| Front and rear parking sensors kit | Tray mat (Freestyle models) |
| Lightforce anti-theft kit | Tray Upgrade kit |
| Railguards (Utilities only) | Tub and tailgate liner (Freestyle models) |
| Remote keyless entry for hard tonneau cover | 16-inch 5-spoke alloy wheels |
| Retractable audio cable (3.5mm male-to-male) | 16-inch 8-spoke black alloy wheels |
| | Polished alloy side steps |

SEE THE FULL RANGE OF MAZDA GENUINE ACCESSORIES AT [MAZDA.COM.AU](https://www.mazda.com.au)

* Tow ball and wiring loom sold separately. Subject to State or Territory regulations.

All care is taken to ensure the accuracy of this brochure and availability of items at the time of publication, however, to the extent permitted by law, Mazda Australia Pty Ltd will not be liable for any loss suffered or incurred by a purchaser or prospective purchaser if the content is inaccurate or not up to date, or if it withdraws any products in the brochure from the market. Equipment shown in the brochure is for illustrative purposes only and does not come standard with the vehicle, or as Mazda Genuine Accessories. Specifications, features and availability may vary from State to State and may change without notice. Please refer to [mazda.com.au](https://www.mazda.com.au) or consult your Mazda Dealer prior to placing an order to ascertain current information on availability, specifications, features and prices. Mazda Australia Pty Ltd ABN 78 004 690 804, 211A Wellington Road, Mulgrave, Victoria 3170. Mazda Genuine Accessories fitted at the point of sale of a new Mazda BT-50 are covered under the Mazda 5 year, unlimited kilometre factory warranty. Mazda Genuine Accessories fitted after the sale of a new Mazda vehicle are covered by the Mazda 2 year or 40,000-kilometre warranty (whichever should occur first). For full terms and conditions please visit <https://www.mazda.com.au/owners/warranty/>
Published December 2018. MAZ13919 129,920