

Compact TMR mixer wagons from 4 to 34 m<sup>3</sup>



PROFILE

[www.kuhn.com](http://www.kuhn.com)



be strong, be **KUHN**



- Potentiel de production de 9 000 kg de lait
- Ration de base
- Énergie nette
- Nettes énergie de lactation
- Acides aminés
- UFL
- Protéines "by pass"
- PDIA + PDIMN = PDIN
- PDIA + PDIME = PDIE
- UFL/jour
- 1 kg de maïs = 0,44 UFL + 48 g PDI

- PDI = PDIA + PDIM
- capacité d'ingestion
- Niveau de production

- Taux de Matière Sèche
- Qualité de conservation
- Finesse de hachage
- Vitesse de la digestion
- Potentiel de production de 9 000 kg de lait



- Condition corporelle
- Poids corporel
- Phase de lactation
- Nombre de lactations précédentes

- Ration de base
- Énergie nette
- Nettes énergie de lactation

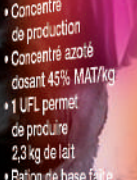

- Concentré de production
- Concentré azoté dosant 45% MAT/kg
- 1 UFL permet de produire 2,3 kg de lait
- Ration de base faite de maïs ensilage et de foin apporté
- 42 UFL 779 PDIN
- 1156 PDIE

- Protéines Digestibles dans l'Intestin d'origine Microbienne
- Primpaire ou multipaire



1

2

3

6

7

8

**PROFILE** Vertical single auger 4 to 15 m<sup>3</sup>

**PROFILE** Vertical twin auger 12 to 34 m<sup>3</sup>

# OVER A THOUSAND POSSIBILITIES... FIND YOURS!



More than ever, the competitiveness of livestock production is attributed to an efficient feeding system on a technical, nutritional and economic level.

KUHN has developed the PROFILE range on the strength of its international experience in design, development and marketing of TMR mixer wagons to meet farmers' new needs:

- Adapt the quantity of each ration component to the needs of the animal with an accurate weighing system.
- Rapidly chop whole bales and fibrous product down to the optimum length, as recommended by independent nutritionists,
- Provide perfectly even mixed rations for a healthier herd (reducing metabolic disorders, etc.),
- Our compact-sized mixer wagons can operate in all types of buildings,
- Machines with a low power requirement to produce cost efficient mixed rations,
- A multitude of distribution possibilities: direct feeding, tilting conveyors, cross-conveyors, at the front, rear, right side or left side,
- Regular distribution of rations over the entire length of the feed-out to avoid competition among animals for feed,
- Multi-purpose mixer wagons that feature high-speed straw blowing!

## PROFILE - Overview:



	Number of augers	Capacity (m <sup>3</sup> )	Distribution	Bedding function
<b>1. PROFILE 1 DS</b>	1	4 - 6	Direct	-
<b>2. PROFILE 1 DL</b>	1	9-10-11-12-13-14-15	Direct	-
<b>3. PROFILE 1 CL</b>	1	9-10-11-12-13-14-15	Cross-conveyor	-
<b>4. PROFILE PLUS 1 DL / 1 CL</b>	1	12-13-14-15	Direct or cross-conveyor	Yes
<b>5. PROFILE 2 DS</b>	2	12-13-14-15-16-18-20	Direct	-
<b>6. PROFILE CROSSMIX 2 CS</b>	2	14-15-16-18-20	Cross-conveyor	-
<b>7. PROFILE PLUS 2 DS / 2 CS</b>	2	15-16-18-20	Direct or cross-conveyor	Yes
<b>8. PROFILE 2 DL</b>	2	18-20-22-24-26-28-30-34	Direct	-
<b>9. PROFILE 2 CL</b>	2	18-20-22-24-26-28-30-34	Cross-conveyor	-
<b>10. PROFILE PLUS 2 DL / 2 CL</b>	2	24-26-28-30-34	Direct or cross-conveyor	Yes



# WHY TRUST THE WORLD LEADER

## EFFICIENT FEEDING SOLUTIONS

The KUHN EFFICIENT FEEDING system provides all the guarantees of a world leader in mixed ration solutions. All KUHN TMR mixers (trailed wagons, self-propelled, free-standing or robotic machines) can handle the most difficult situations in terms of working conditions and fodder diversity. Our TMR mixer wagons meet all applicable nutritional standards and have been proven through further successful testing in different continents. Our feeding solutions are also designed to meet all building, tractor and loader requirements. We provide data management systems for farms committed to high standards of traceability. We provide numerous services such as EFFICIENT FEEDING FEED to provide the advice you need to optimise your investment, whether you are a first-time buyer or upgrading your machine.



## ASK YOURSELF THE RIGHT QUESTIONS BEFORE INVESTING

The network of KUHN partners near you can help you choose the right machine.

Ask yourself the right questions to evaluate your investment:

### WHAT TUB CAPACITY DO I NEED?

The volume occupied by each type of fodder is different and often based on the quantity of dry matter. To determine the volume occupied by your ration, the app "Click & Mix" is available in the "services" tab of the [www.kuhn.com](http://www.kuhn.com) website to help you calculate the necessary volume.

Take extra care when preparing fibrous rations! It is important to explore all different options including those for young cattle made up of predominantly long, dry fibres.

The PROFILE mixer wagons are scalable in terms of capacity. If you change rations or expand your herd, you can easily increase your machine capacity with the extensions available.

### WHICH MACHINE CONFIGURATION?

When choosing your PROFILE, we suggest that you identify possible machine restrictions, including: maximum heights, feed passage configurations (i.e. troughs), shed entrances/exits and the possible requirement to feed simultaneously from both sides. We can then provide a machine tailored to your needs.

### WHAT POWER AND WHICH LOADING MODE DO I NEED?

Gearbox options can allow the tractor power requirement to be reduced, adapting to your tractor. Several control system options are available, giving you a choice of hydraulic functions. These can also be adapted to the hydraulic equipment on your tractor.

The PROFILE range volumes offer single or twin auger models for low height loading systems. Vertical twin auger models feature a lower overall height with an equivalent volume.

### WHAT INTENSITY OF USE?

Farm size and number of rations per day are also important factors when selecting your machine. Optional equipment such as carbide coated knives, K-NOX mixing augers and specific tyres can help to protect your PROFILE against the effects of wear over time.

# MIXING



## EXCEPTIONAL MIXING QUALITY AT ALL FILL LEVELS!

For a healthy herd, the ration must be evenly mixed and perfectly distributed, no matter what the levels of dry matter are or how full the tub is.

The PROFILE range's mixing auger was designed with the chopping performance of long fibres in mind, as well as preserving wetter fodders such as maize silage.

Based on official tests conducted by the DLG, the range obtained top scores for fodder expansion and mixing quality with the tub both full and half-full. You will obtain an excellent mixing quality in small rations even when making premixes or lighter rations for dairy cattle turned out to pasture, etc.



## EXCLUSIVE KUHN MIXING AUGER!

The double-pitch angle of the auger enables quick breakdown of feed, no matter how full the machine already is. To reduce power consumption, the PROFILE range is equipped with asymmetric knives which give a "self-cleaning" effect and also have a progressive-cutting knife edge for constant torque transfer. The continuous auger helix naturally moves the fodder from the bottom to the top of the tub for even mixing with no forced movements, reducing fuel consumption during the mixing process. The auger material and design has been selected to provide maximum resistance to wear.

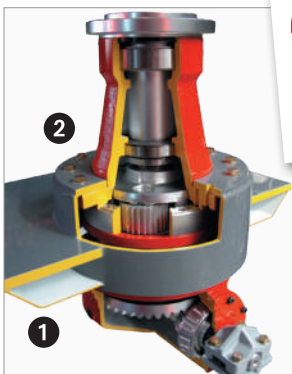

**2000** machines  
per year!  
Exclusive to **KUHN**

## TRIED AND TESTED TRANSMISSION AND DRIVE SYSTEMS!

The machine transmission is made up of a two-stage bearing therefore even during breakdown of a whole bale, stress is absorbed. The combination of the pre-stressed subframe (1) and the solid auger base provides maximum resistance to the load bearing in the bottom of

the machine.



The unit is fitted on a collar (2) which reaches up to approximately half the auger height, thus protecting the transmission from lateral forces exerted on the auger.

Based on KUHN technology, the angle gearbox is known for its reliability and used on all the 2000 mixer wagons produced each year.



# SURGICAL PRECISION: 1,2%

## Mixing quality and homogeneity

Laden weight and fill level of the mixing tub	<p>1940 Kg</p>  <p>50%</p>	<p>3830 Kg</p>  <p>100%</p>
Difference between the 8 trough samples	<p>1.7%</p>	<p>1.2%</p>
DLG comments	<p><b>+</b> (maximum score)</p>	<p><b>+</b> (maximum score)</p>
What this means for you	<p>You can produce high-quality "small mixtures": for premixes or rations for dry cows or heifers.</p>	<p>Guaranteed high-quality rations for the entire herd for improved performance!</p>

\* Deutsche Landwirtschafts-Gesellschaft, 27,000-member German Agricultural Society, a technical and professional organisation with full political and financial independence. The 8 samples were taken over the length of the feeding table. The ration was mixed for 3 minutes.



# POWER REQUIREMENT:

**YOUR PROFILE MIXER WAGON WORKS WITH ANY TYPE OF TRACTOR!**

In addition to the nutritional quality of the mixed ration, production cost is a key financial factor affecting total livestock feed costs. The power required to produce the ration is a determining factor when making an investment, and you can compare the mixer solutions to help you decide.

To precisely evaluate the power requirement for a mixer wagon, DLG has developed an official certified protocol to determine energy ratings.

In order to comply with these new standards, the power requirement per tonne of mixture is included in the PROFILE model development specifications from the first stages of design.

The most logical and economical solution for your old mid-range tractor is to put it to work pulling the PROFILE mixer wagon. It will be eager to start up every morning!



## POWER REQUIREMENT: Quality mixer wagons at an unbeatable price!

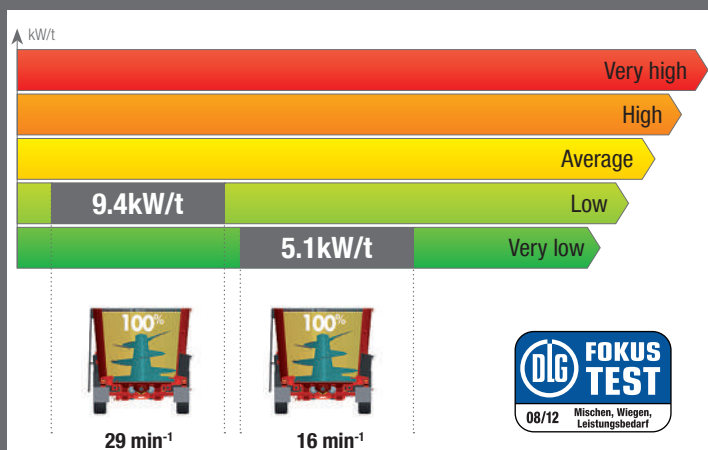

### DLG TEST PROTOCOL:

The power absorbed during ration mixing was determined by measuring the required drive power.

It was measured using a hub-type torque transducer applied between the power take-off and the transmission of the PROFILE mixer wagon.

The measurements were taken at two rotation speeds (29 and 16 min<sup>-1</sup>).

# 7hp per tonne of mixture

SAVE MONEY ON FUEL!

**The lower power requirement of the PROFILE range is the result of several technological breakthroughs:**

**Auger design:** The continuous helix of the mixing auger causes the fodder to gravitate from the bottom of the tub to the top without any forced movements. The mixing process is performed easily and smoothly for greater fuel efficiency.

**Auger diameter:** The smaller the auger diameter, the shorter the scraper arm, resulting in reduced power requirement.

**Auger rotation direction:** In vertical twin auger mixer wagons, the augers rotate the mixture in a figure-of-eight pattern. This ensures regular fodder circulation and prevents material from blocking up against the sides of the tub for improved energy efficiency.

**The optional two-speed gearbox further reduces the power requirement.** This option is recommended for farmers who travel long distances with a loaded mixer wagon. Reducing the auger speed will allow for smooth start-up before the ration distribution phase.





### DON'T COMPROMISE ON CHOPPING SPEED

Reducing the power requirement is a key objective, along with fast chopping and mixing. The PROFILE models feature polygonal-shaped tubs. So as opposed to “rolled” bodies, the tubs have multiple sides. This design also saves time when chopping longer forage. The counter-knives are positioned diagonally with respect to the auger axis and articulated from the top. The lower parts of the counter-knives are much closer to the auger knives. This saves you time when preparing the ration.

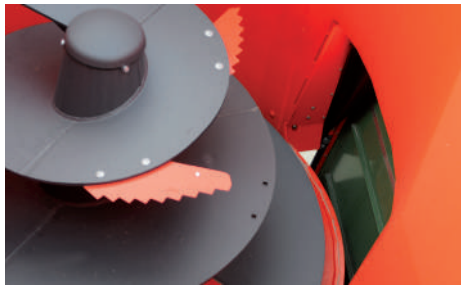

### CUSTOMISE THE AUGER POWER!

To reduce power requirement, the PROFILE mixer wagons are fitted with progressive cutting knives with constant torque transfer. For fibrous rations, the size and number of knives can be modified for faster break-up of whole bales and chopping long-fibres. The different sized knives also play an important role. The longer knives reach round the whole tub, ensuring there are no “dead” zones where the fodder could get stuck. The shorter knives guarantee the chopping effect at all levels of the auger.

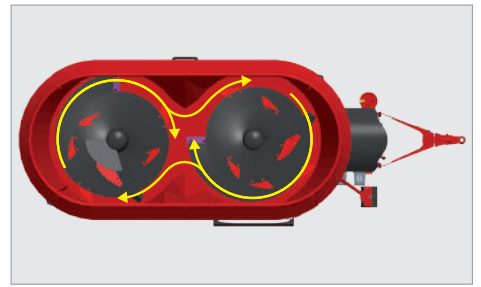

### EXCELLENT MIXING QUALITY GUARANTEED!

On PROFILE vertical twin-auger mixer wagons, a straight-line transmission links the two augers to the primary transmission, thus reducing load losses, which are often significant in offset gearboxes. The linked mixing augers rotate in the same direction. The mixture rotates in a figure-of-eight pattern to prevent the fodder from blocking up against the sides of the tub. The tractor runs smoothly with no sudden increases in power requirement.

# DISTRIBUTION SOLUTIONS: CONFIGURE YOUR PROFILE MACHINE TO MEET YOUR NEEDS, NOT THE OTHER WAY ROUND!

For each member of the herd to get their maximum feed intake, the feed-out of the mixed ration must be evenly mixed and distributed across the whole length of the feed passage. It's important to reduce competition for feed between livestock in the same batch. All animals must get their fair share of quality mixed rations!

When the animals return to the buildings after grazing, providing a homogeneous ration is the best solution to avoid them pushing and shoving for feed.

The PROFILE range features an impressive selection of discharge solutions to ensure distribution of the rations in all the types of buildings. Whether you have sheds with no separate exit, troughs with retaining rims or very narrow feed passages, feeding tables on both sides of the passage requiring simultaneous distribution, or other constraints requiring distribution from the rear of the machine, you will find what you need in the PROFILE range.

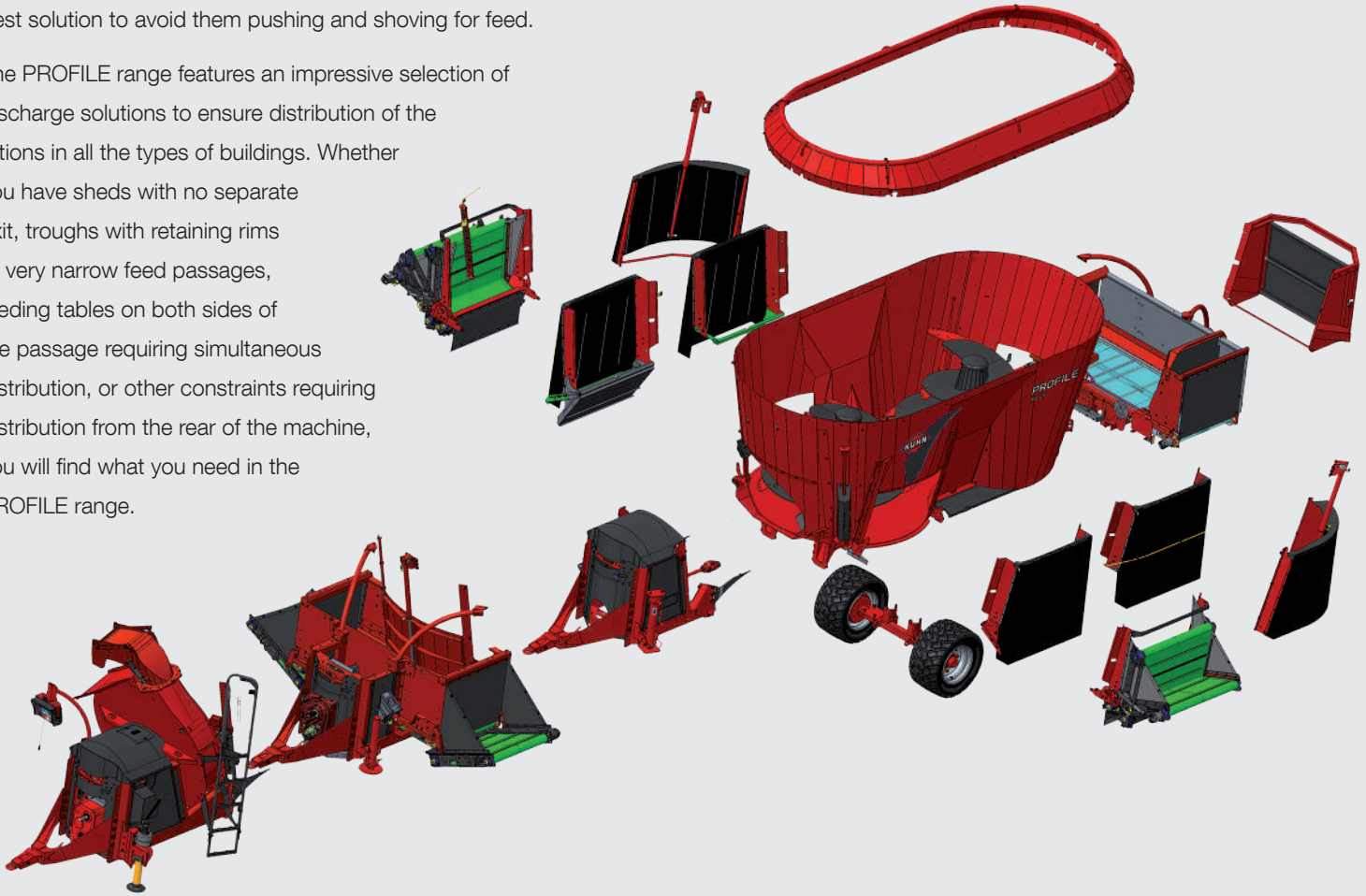

## MAKE THE RIGHT CHOICE!



When considering your investment, you must also keep in mind the layout of your buildings and feeding tables. KUHNS approved partners do their best to make your investment a success.

**Website:** In the "Bedding and Feeding" section of our websites, we provide information to help you choose your PROFILE mixer wagon.

**Commercial configurator:** KUHNS partners have a configurator to analyse your requirements and select the best combination of feed distribution and tyre options. No unpleasant surprises upon delivery!

**Private demonstration:** get a free on-farm demonstration with your KUHNS partner, to appreciate the convenience of your future PROFILE mixer wagon.



### DISTRIBUTION CHUTES: EXPRESS DELIVERY!

Distribution chutes can be fitted upon request at the front right or left, rear right or left, etc. for feed delivery in all building configurations.

The doors are the largest on the market (their width represents over 60% of the auger diameter).

The PROFILE mixer wagon is fitted with a deflection plate to avoid driving over the feed-out. The protective canvas prevents fodder projections beyond the trough.



### TILTING CONVEYORS TO ADAPT TO ALL TYPES OF TROUGHS

The PROFILE range can be fitted with a large selection of hydraulically tilted conveyors to deliver feed to raised troughs. The tilting conveyors come in different lengths and are designed with PVC belts. They start up automatically when the hatch door is opened to prevent forage build-up at the tub outlet.

The PROFILE tilting conveyors are quiet, always clean and easy to service: simply adjust the belt tension on a regular basis.



### CROSS-CONVEYOR: MAXIMUM VISIBILITY

The cross-conveyor can be positioned at the front or rear of the PROFILE range. Feed can be distributed on the left or right-hand side, as standard. The conveyor is driven by a hydraulic motor at each end guaranteeing perfect operation regardless of the rotation direction.

The PVC belt ensures that fodder doesn't travel back underneath the belt. The feed passage always remains clean after distribution.

As an option, the cross-conveyor can be hydraulically offset by 250 mm to the left or the right of the machine: ideal for fibrous rations!

# FLEXILIFT

Telescoping discharge conveyor built into the frame of the mixer wagon. KUHN patented system



► The FLEXILIFT conveyor is a new alternative to cross-conveyors. It allows for delivery into high troughs (1,200 mm) without protruding from the mixer wagon.

► FLEXILIFT is available as an option on all PROFILE C range models (single and double vertical augers).

► The angle of the belt will depend on the degree of extension: one simple control takes care of both movements.

► FLEXILIFT is designed with a continuous belt. There is no product loss in the feed passage, unlike standard tilting conveyors and cross-conveyors, which have joints.

► FLEXILIFT is reversible and symmetrical. Depending on which side you want the raised conveyor on, your KUHN authorised dealer can easily reverse the conveyor during start-up.



# STRAW BLOWING TURBINE:

## ADD VERSATILITY TO YOUR PROFILE MIXER WAGON!

For farms that use straw bedding, the PROFILE PLUS range is fitted with a straw blowing turbine. This additional feature on the mixer wagon maximises your investment using the same tractor.

The throughput, flow regularity and bedding structure are identical to those on our PRIMOR straw blowers and feeders. KUHN's internationally recognised straw blowing quality is available on both the PROFILE PLUS vertical single and vertical twin auger models.

To serve all your distribution needs, the PROFILE PLUS models are available with direct distribution chutes, tilting conveyors as well as cross-conveyors.



# 158kg

of straw per minute

### VENTIDRIVE PATENTED DOOR: KUHN INVENTS GEO-SUCTION!

The turbine access door on the PROFILE PLUS is asymmetrical. It is now proven that the air flow between the mixer tub and the blowing turbine can differ from zone to zone. With a standard rectangular door, the backflow would result in uneven straw output. The VENTIDRIVE door design optimises suction to the turbine and eliminates all backflow. The straw output is regular and independent of the auger passage. No "guillotine" movements are required to be carried out with the access door.

You will be impressed by the straw blowing output. Instantaneous flow rates can reach up to 158 kg of straw per minute! Uniform straw suction is achieved at low tractor engine speed, saving you fuel and reducing noise in the stalls to improve animal welfare.



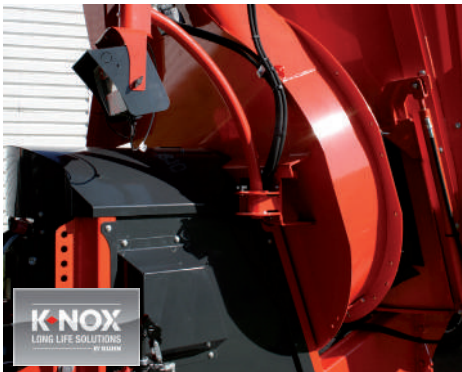

### PROJECTION OF UP TO 18 M

PROFILE PLUS machines feature the same large turbine as the PRIMOR straw blowers and feeders. Its 1540 mm chute ensures straw projection up to 18 m on the right hand side to reach even the farthest corners of your bedding areas.

The turbine does not increase the PROFILE PLUS footprint, so it can be used in narrow spaces such as cubicle alleys. It is positioned on the front of the mixer wagon so you can easily see and control the straw flow trajectory. The bottom of the turbine is made from abrasion and corrosion resistant K-NOX (stainless steel) for longer life!

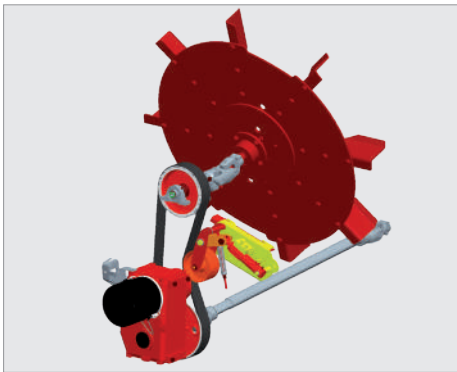

### MORE FLEXIBLE DRIVE SYSTEM

The PROFILE PLUS mixer wagon turbine is driven by a belt rotating at 650 rpm. The system is quiet, easy to service and can be engaged or disengaged. The belt is engaged and tensioned hydraulically from the controls in the tractor cab. Once the PTO and the mixing augers start up, you can choose to engage or disengage the straw blowing turbine. This system is based on the patented POLYDRIVE system that controls the feed rotors on PRIMOR straw bedders.



### BROADEN YOUR HORIZONS!

As an option, the PROFILE PLUS models can be fitted with a 220° swivel chute. The standard chute is pre-equipped to be retrofitted with the 220° kit if you decide you need it later!

The turbine is slightly separated from the mixing tub so the chute can swivel 20° behind the machine. You can project straw along the entire length of the machine to access all the bedding spaces from a feed passage with no separate exit. The quick-acting chute cap controlled by a hydraulic cylinder lets you change the straw blowing distance in an instant.

PROFILE

4.1 DS

6.1 DS

# MIXED RATIONS FOR ALL TYPES OF LIVESTOCK FARMS

The PROFILE 4.1 DS and 6.1 DS were designed to provide mixed rations for all types of farms. Ease of use and compact-size are the two key features of these machines. With the possibility for left and right-hand side distribution and a low overall height, the machines can navigate their way through difficult-to-access buildings. The vertical auger guarantees exceptional mixing quality and can chop fodder into small fibres required by smaller ruminants (i.e. goats and sheep). The standard programmable electronic weighing system ensures the accuracy of the quantities loaded and distributed. It features a small auger diameter (1.69 m) with a low power requirement so it can be used with small farmyard tractors (40 hp required for the 4 m<sup>3</sup> version).



# 1 AUGER 4 to 6 m<sup>3</sup>

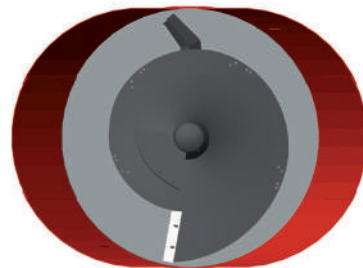

This PROFILE vertical single auger mixer wagon available in 4 and 6 m<sup>3</sup> is a superior entry-level model for feed management systems. It is equipped with a programmable weighing system as standard so you can accurately load each component of your ration.

You can choose between direct control from the tractor's distributors or electric controls, to adapt the solution to the hydraulic equipment of your tractor and the level of comfort and convenience you want.

Its axle positioned at the rear of the tub provides excellent stability with high ground clearance.

## MODULAR FEATURES!

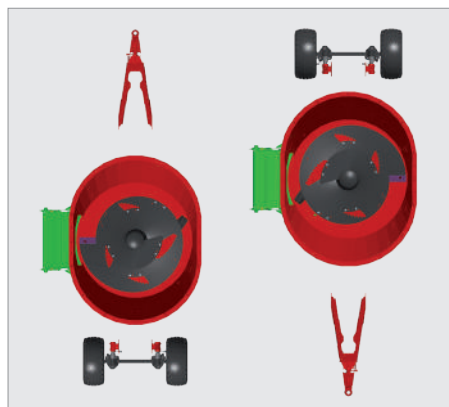

### RIGHT, LEFT OR BOTH: THE CHOICE IS YOURS

The mixer tub on the PROFILE 4.1 DS and 6.1 DS was designed to be perfectly symmetrical. If you order this machine today in the right side distribution version and later you need left side distribution, there's no problem! The drawbar and the axle are bolted to the same rack on the tub. Just reverse them to convert to a left-side distribution mixer wagon. This special feature will also appeal to buyers of second-hand mixer wagons.



### MANY POSSIBLE DISTRIBUTION CONFIGURATIONS

On the standard version, the distribution unit can be positioned on the right or the left of the machine. The height and depth of the standard distribution chute can be adjusted. For troughs, a tilting conveyor is available in three different lengths to deliver the fodder at the required height. Bilateral right/left distribution is available as an option to deliver feed on both sides of the machine in a single pass.

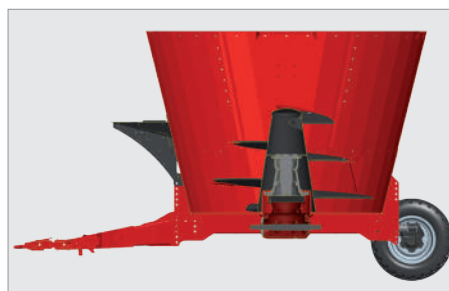

### EXTREMELY COMPACT

These PROFILE single vertical auger models are available in 6 m<sup>3</sup> with a height of less than 2.40 m to manoeuvre through all types of buildings. The axle positioned at the back of the tub considerably reduces the height, making it easier to load the machine with mini-loaders. The machines are also extremely stable in difficult or uneven terrain.

<b>PROFILE</b>	9.1	10.1	11.1	12.1	13.1	14.1	15.1	<b>DL</b>
<b>PROFILE</b>	9.1	10.1	11.1	12.1	13.1	14.1	15.1	<b>CL</b>
<b>PROFILE PLUS</b>	12.1	13.1	14.1	15.1	<b>DL</b>	<b>CL</b>		

# EXTRA CAPACITY!

The largest capacity with the lowest height on the market! The new generation of vertical single auger mixer wagons offers a new solution for all farmers with difficult-to-access buildings and/or who need a variety of non-standard distribution configurations. Compact size is the key feature of these PROFILE single-auger mixer wagons. The tub geometry enables larger capacities at lower heights, for example the 13 m<sup>3</sup> model comes in at just under 3 m overall height. This range is also available with direct distribution (DL models), cross-conveyors (CL models) or a straw blowing turbine (PLUS models), to meet all your needs!





# 1 AUGER 9 to 15 m<sup>3</sup>

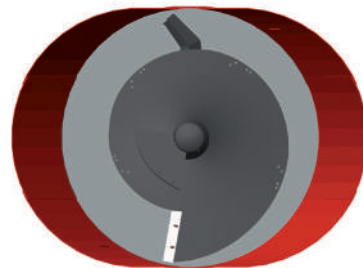

The new PROFILE single vertical auger models are available in 7 different sizes (from 9 to 15 m<sup>3</sup>), with the lowest overall heights on the market.

These mixer wagons embody all of Kuhn's expertise when it comes to TMR mixers: scalable capacity, oversized angle gearbox, direct or electronic controls, polygonal tub for faster chopping, customised auger depending on the rations, large counter-knives, and the VENTIDRIVE patented system on the "PLUS" version (straw blowing turbine).



## GREATER CAPACITY FOR GREATER SAVINGS!



### THE LOWEST HEIGHT ON THE MARKET!

The built-in frame on the PROFILE single-auger range was designed to keep height to a minimum to manoeuvre in difficult-to-access buildings while maintaining excellent weighing accuracy. This design provides for excellent ground clearance for all types of terrain!

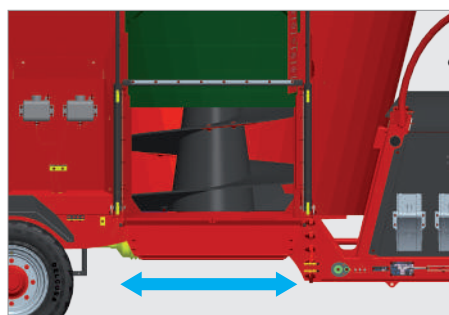

### COMPARE THE "DOOR WIDTH / AUGER DIAMETER" RATIO!!!

Save time with the PROFILE single auger range designed to accelerate discharge speed. The doors are 1100 mm wide, which is 60% of the auger diameter. This unbeatable ratio guarantees fast, regular distribution even when delivering fibrous rations. The tub can be equipped with one or more discharge doors depending on the configuration of your buildings.



### WEIGHING ACCURACY FOR SUPERIOR FEED MANAGEMENT!

The three weigh cells of the mixer wagon are arranged in a triangle, so the stability and load distribution are identical on each of the three weigh cells. The weighing unit is accurate to the nearest kilogramme! This unit is positioned on a 3D articulated support. The display is visible from any loading position and in all lighting conditions.

<b>PROFILE</b>	12.2	13.2	14.2	15.2	16.2	18.2	20.2	DS
<b>PROFILE</b>	14.2	15.2	16.2	18.2	20.2	<b>CS</b>		
<b>PROFILE PLUS</b>	15.2	16.2	18.2	20.2	<b>DS</b>	<b>CS</b>		

# COUNTLESS SOLUTIONS!

The countless distribution configurations make this new range of PROFILE vertical twin-auger mixer wagons unique. Due to awkward building configurations, many farms have been unable to switch to mixed rations. The PROFILE vertical twin-auger mixer wagon is the practical solution. The machines are available with direct feed, a front or rear cross-conveyor and a straw blowing turbine for maximum versatility. The two augers driven on the same axle mix the product in a figure-of-eight pattern, which allows for optimum product flow in the tub, with no blockages and no additional power requirement. Like the PROFILE single-auger mixer wagons, the wide discharge doors (1100 mm) ensure a quick clean-out of the entire tub.



# 2 MIXING AUGERS 12 to 20 m<sup>3</sup>

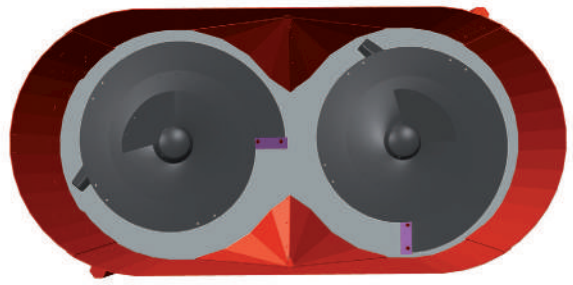

Superior performance at all sizes! The PROFILE vertical twin auger range starts at 12 m<sup>3</sup> for farms with height constraints, and features models with capacities up to 20 m<sup>3</sup> for fibrous rations!

These new models are equipped with small diameter mixing augers that require less power.

The PROFILE vertical twin-auger mixer wagon features a simple and highly functional design with a low loading height. The wheels are mounted under the tub to reduce overall machine width to just 1.85 m, enabling the machine to fit in different distribution configurations.



## OVERSIZE DIMENSIONS!



### 12 M<sup>3</sup> CAPACITY AND JUST 2.33 M HIGH

The PROFILE vertical twin-auger machines offer the best capacity-to-height ratio on the market. The frame built in to the tub significantly reduces the machine height while maintaining good ground clearance on uneven terrain. The 12 and 13 m<sup>3</sup> models can be loaded with mini-loaders equipped with standard buckets.



### PERFECTLY CONTROLLED FILL RATE

The flared shape of the front, rear and sides of the tub (specific to the PROFILE models) ensures smooth fodder circulation. The entire volume of the tub is used during chopping and mixing. There are no "dead" zones or fodder build-up: every m<sup>3</sup> is used! The double-pitch coil of each auger guarantees that the fodder is fully mixed at the end of the process.



### FEED ACCORDING TO THE NEED...

The tub wall assembly technique offers 6 different locations for the distribution doors. Each one can be fitted with a distribution unit or tilting conveyors in different lengths for delivery to troughs. The PROFILE 2 CS models are designed with a large cross-conveyor that can be mounted at the front or the rear of the machine. On "PLUS" versions featuring a straw blowing turbine, the material can be distributed via distribution chutes or the cross-conveyor.

# CROSS-MIX VERSION OF THE PROFILE RANGE!

The PROFILE CROSSMIX 2 CS is designed with the wheels outside the tub for farms with buildings that are far apart across uneven or difficult terrain. The large diameter tyres integrated into the chassis ensure excellent driving in difficult conditions. PROFILE CROSSMIX 2 CS mixer wagons are designed to go anywhere.

Another key feature of the PROFILE CROSSMIX 2 CS range is undoubtedly the distribution quality (speed and regularity), with its large cross-conveyor positioned at the front of the machine.



# 2 MIXING AUGERS 14 to 20 m<sup>3</sup>

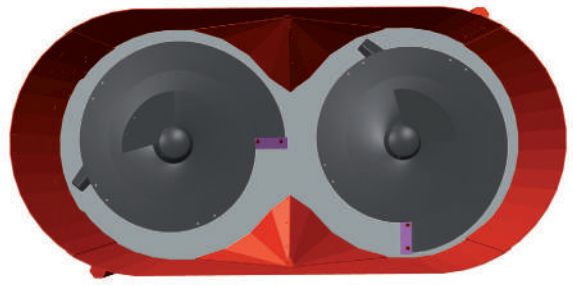

The PROFILE CROSSMIX 2 CS comes in five different capacities: 14, 15, 16, 18 and 20 m<sup>3</sup>. Choose the 14.2 CS model with a height of 2.55 m for its compact size. The 18.2 CS and 20.2 CS models (18 and 20 m<sup>3</sup> respectively) are recommended for fibrous rations.

The anti-overflow extensions fitted as standard on every model from the 15.2 CS and up prevent long-fibre fodder from falling out during the chopping process.

Like the other PROFILE vertical two-auger models, the small diameter of the augers (1.84 m) requires less power, thereby saving you fuel.

## THE ULTIMATE ALL-TERRAIN MACHINE



### BUILT-IN FRAME AND RECESSED WHEELS

The position of the wheels under the body keeps the overall width down to just 2.40 m for the 14 m<sup>3</sup> version! The built-in frame and tub concept guarantees the structure will last a long time, while

- significantly reducing the overall height: the machine can follow the tractor into the lowest buildings,
- maintaining good ground clearance (390 mm with 385/55 R22.5 tyres). Buildings with uneven floors are no longer a problem!



### EXTRA WIDE DOOR FOR FIBROUS RATIONS!

The PROFILE CROSSMIX 2 CS comes with a wide cross-conveyor as standard to deliver the feed-out on the right and on the left of the machine, and also features an extra wide door. The 1200 mm wide opening can deliver fibrous rations from the tub without requiring excessive chopping. The mixing augers feature a second double-bent scraper to guide the long strands towards the door without being recirculated back around the tub.



### FRONT-MOUNTED CROSS-CONVEYOR: SUPERIOR VISIBILITY!

The cross-conveyor enables right and left side distribution as standard. The conveyor is driven by a hydraulic motor at each end guaranteeing perfect belt tension regardless of the rotation direction. The PVC conveyor belt is quiet and always remains clean (no fodder build-up that could contaminate the mix). For fibrous rations, the conveyor can be hydraulically offset to the right or the left by 250 mm to avoid the machine driving over the feed-out.

<b>PROFILE</b>	18.2	20.2	22.2	24.2	26.2	28.2	30.2	34.2	<b>DL</b>
<b>PROFILE</b>	18.2	20.2	22.2	24.2	26.2	28.2	30.2	34.2	<b>CL</b>
<b>PROFILE PLUS</b>	24.2	26.2	28.2	30.2	34.2	<b>DL</b>	<b>CL</b>		

# YOU'VE BEEN UPGRADED!

The PROFILE (PLUS) 2 DL-2 CL double-auger vertical mixer wagons are designed for intensive use. With capacities starting at 18 m<sup>3</sup>, ideal for manoeuvring in tight spaces, to 34 m<sup>3</sup> for farmers working on a larger scale, this range of PROFILE mixer wagons sets a whole new standard for trailed mixers. You will love the upgrade to a class of accessories and equipment never before seen on this category of machine. With the patented weighing system, the 250 possible configurations and the K-NOX mixing augers, the PROFILE (PLUS) 2 DL-2 CL mixer wagons are your new allies for sustainable precision feeding.



# 2 MIXING AUGERS

## 18 to 34 m<sup>3</sup>

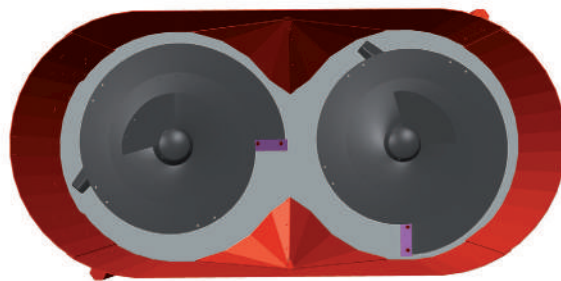

Available in 8 capacities, the PROFILE (PLUS) 2 DL-2 CL mixer wagons have been designed to make the most of maximum tub capacity with the lowest height possible.

The integrated chassis and patented weighing system with 5 load cells minimizes the height while providing excellent ground clearance.

The PLUS version with a straw-blowing turbine features the VENTIDRIVE system, keeping the machine length to a minimum.

Available in single axle for the 18 to 26 m<sup>3</sup> models and in bogie axle for the 28 to 34 m<sup>3</sup> models, the PROFILE (PLUS) 2 DL-2 CL mixer wagon is built to handle the road.

## UP TO 20% MORE CAPACITY!



### WHY GET LESS CAPACITY FOR THE SAME HEIGHT?

The height/width ratio of the mixing tub places the PROFILE (PLUS) 2 DL-2 CL models firmly among the most compact solutions on the market.

The integrated chassis reduces the overall height of the machine, while retaining excellent ground clearance.

The tapered shape of the tubs on the PROFILE (PLUS) 2 DL-2 CL gives you extra capacity without compromising the product flow or the quality of the mixture.

As a concrete example, for a height constraint of 3.20 m, you have 28 m<sup>3</sup> with the PROFILE (PLUS) 28.2 DL-CL, or up to 17% extra capacity compared to other machines on the market.



3,20 m

Overall height

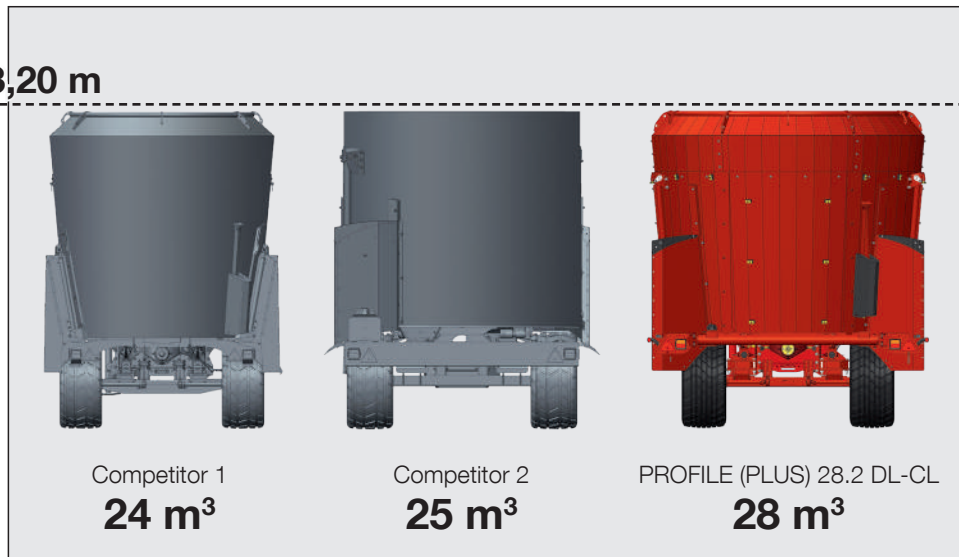

<b>PROFILE</b>	18.2	20.2	22.2	24.2	26.2	28.2	30.2	34.2	<b>DL</b>
<b>PROFILE</b>	18.2	20.2	22.2	24.2	26.2	28.2	30.2	34.2	<b>CL</b>
<b>PROFILE PLUS</b>	24.2	26.2	28.2	30.2	34.2	<b>DL</b>	<b>CL</b>		

# FOR INTENSIVE USE!



## 5 load cells: a patented KUHN exclusive!

**Precision in small mixtures and accuracy for large tonnages**

The weighing system on the PROFILE (PLUS) 2 DL-2 CL range is designed with load cells integrated into a cradle between the axle and the tub. The load cells are positioned in the direction of travel of the machine, not perpendicularly. None of the constraints related to transport affect the structure of the load cells.

The sensitivity of the 63.50 mm diameter load cells is much better than for 80 mm load cells. Small mixtures (pre-mixes of a few dozen kilograms) will be weighed and managed with greater precision.

The large number of load cells - five in all for the PROFILE (PLUS) 2 DL-2 CL range - improves the weighing accuracy for even the heaviest mixtures (mixtures of fodder and feed with a low percentage of dry matter).

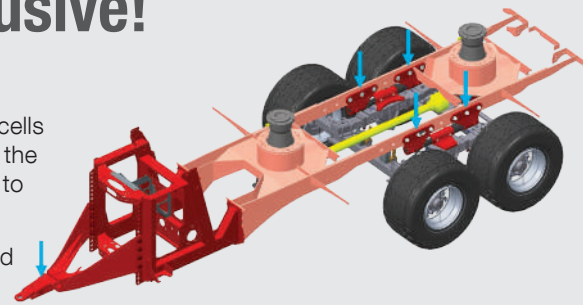

### PRECISION FOR CONCENTRATES AND.....



### ACCURACY FOR LARGE TONNAGES !





# K-NOX TECHNOLOGY



To ensure the long-term performance of your PROFILE (PLUS) 2 DL-2 CL mixer wagon, the optional K-NOX auger mixers are designed to substantially reduce wear and tear caused by abrasion and silage acidity.

- ▶ The wear and tear which affects the mixing auger over the years will be spread evenly across the whole surface of the mixing coil and also on the central cone. That's why K-NOX mixing augers are built entirely from the same alloy: coil, cone and scraper.
- ▶ K-NOX is an alloy containing:
  - Chrome for the most "stainless" steel providing greater resistance to silage acids,
  - Ferrites for mechanical resistance in particular when loading heavy products.
- ▶ The K-NOX technology will increase the resale value of your machine should you decide to sell it. Second-hand mixers are valued based on the wear of the augers, rather than their age. A machine whose main components are still in perfect condition will naturally retain a higher resale value.



## More than **250** different configurations

All of the DL-CL-PLUS versions are compatible with additional distribution modules in order to offer total compatibility with all barn and feed table configurations: tilting conveyor belts of varying sizes, hydraulic offset, a combination of front and/or rear chutes, etc.

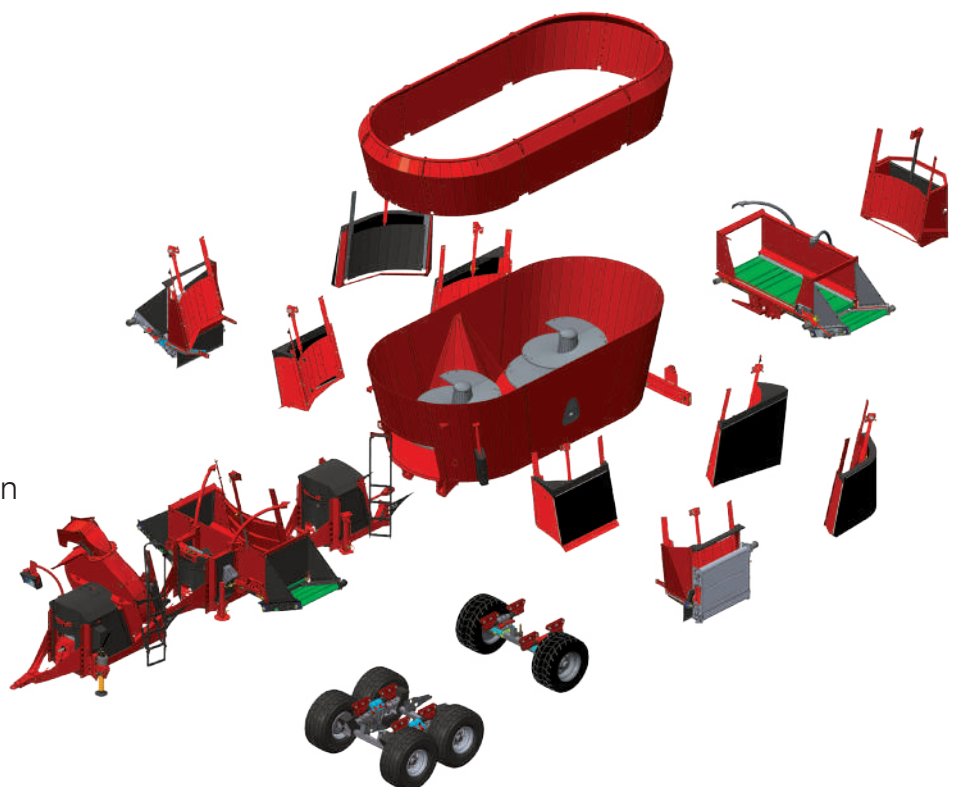

# FEED MANAGEMENT

## LET IT BE YOUR DAILY GUIDE!

With the KUHN DG 600 terminal, you optimise your time by carefully preparing the quantities of the different ration ingredients. Simply program the rations per head and per batch before loading the TMR mixer. In the following days, all you have to do is validate or modify the number of animals in each batch so that the weighing unit automatically indicates the quantities to be loaded.

And if you want to take data management a step further, choose the KUHN DG 8000-IC terminal.



### KUHN DG 600 PROGRAMMABLE WEIGHING SYSTEM\*

Your terminal's interface is intuitive thanks to its double LCD screen that displays the weight and the name of the ingredient simultaneously. You can name your ingredients, distribution points and recipes. Your weighing terminal can store 99 recipes composed of 24 ingredients, and can be used to prepare 48 feed batches. You can program by head or by total weight. You can also generate ingredient consumption reports.

### KUHN DG 8000-IC PROGRAMMABLE WEIGHING SYSTEM\*

Your weighing terminal can store 99 recipes composed of 24 ingredients each, 99 ingredients, 128 feed batches and 48 customers. You can change the number of animals on the terminal. You program the terminal using the "DTM IC Cloud" software: by head, total number of animals or percentages. The KUHN DG 8000-IC weighing terminal is compatible with the NIR dry matter measuring system and the feed tracking system (automatic feeding per batch).

## YOUR PROGRAMMABLE WEIGHING TERMINAL FEATURES DATA TRANSFER SOFTWARE AS AN OPTION:

Details	DTM ADVANCE Cloud software for DG 600	DTM IC Cloud software for DG 8000-IC
Programming (via cloud communication) from PC or smartphone	◆	◆
Editing of ingredients, rations and feed batches from the weighing terminal	◆	-
Editing of the number of animals from the weighing terminal	◆	◆
Lists and reports of completed programs with summary of operator discrepancies	◆	◆ (with graphs)
Multi-user management (admin – users)	◆	◆
Customisation of performances' indicators	◆	◆
Data exchange via 3G modem or USB flash drive	◆	◆
Calculation of ration costs and dry matter content	◆	◆
Stock management	◆	◆ (including leftovers)
Interface with third-party management software (Xls, Delpro, CaptaPlus, UNIFORM-Agri, etc.)	-	◆
Machine fleet management, task assignment per machine	-	◆
Customisation of reports and graphs	-	◆
Pre-mix function	-	◆

◆ Standard - Not available \* Weighing systems not available in all countries. For further information, contact your authorised KUHN partner.

## CHOOSE YOUR DIGITAL ASSISTANT! \*

You can choose one of these digital devices to run the solutions offered along with the weighing terminals. You can take your new assistant with you everywhere! You'll be able to control your mixer weighing system during loading and feeding, but also from your office.



### INDESTRUCTIBLE BLACKVIEW BV5900 SMARTPHONE: YOUR WEIGHING SYSTEM IN YOUR POCKET!

- Dimensions: 80 x 159 x 15 mm - Weight: 268 g
- 5.7" colour touchscreen with 720 x 1520 px resolution
- Standby time: 690 hours
- Rugged: 360° all-round collision mitigation
- IP68 (watertight) and fully dustproof
- Operating temperature: -20 to +60°C
- QUAD CORE 2 Ghz processor
- Comes with a 220 V, 12 V USB charger and a suction cup mount
- Unlocked: no SIM card included. Insert your own SIM card to get the most out of your smartphone.



### ALL TERRAIN CROSSCALL CORE-T4 TABLET FOR OPTIMAL NAVIGATION!

- Dimensions: 225 x 135 x 14 mm - Weight: 610 g
- 8" screen (Format: 16:10) with 1280x800 px resolution and Wet Touch/Glove Touch features (no need to remove your gloves to use it)
- Standby time: 756 hours
- Rugged: resists 1.5 m drops on its six sides
- IP68 (fully resistant to most liquids, withstands immersion up to 2 m for 30 minutes) and fully dustproof
- Operating temperature: -25 to + 50°C
- OCTO-CORE 1.8 Ghz processor
- Comes with a 220 V, 12 V USB charger and a suction cup mount
- Unlocked: SIM card not included. Insert your own SIM card to get the most out of your tablet.

## TWO DIFFERENT INTERFACES TO FIT HOW YOU MANAGE YOUR FEED-RELATED INFORMATION\*

The 2 applications KUHN Datamix VIEW and KUHN Datamix CONTROL are pre-installed on your weighing assistant. You're bound to have all your needs met with the easy-to-use secondary display unit (KUHN Datamix VIEW) and the application that lets you program and perform all the functions of your mixer's weighing unit from your assistant (KUHN Datamix CONTROL). You can access all the weighing data within a communication range of 90 m around your machine. The signal is automatically reset when you re-enter the range.



### WITH THE KUHN DATAMIX VIEW, YOUR ASSISTANT BECOMES THE SECONDARY DISPLAY YOU'LL NEVER LEAVE BEHIND!

- Secondary display of the mixer's main terminal: optimal visibility of the weighing information wherever you are,
- Modification of the order of ingredients while loading,
- Recipe call-up from the loader,
- Forward to the next ingredient and/or return to the previous one,
- Display of gross weight and net weight with automatic net weight reset.

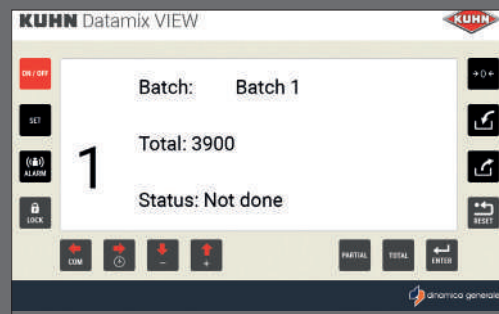

### WITH THE KUHN DATAMIX CONTROL, YOUR ASSISTANT BECOMES THE CONTROL CENTRE FOR YOUR MACHINE'S WEIGHING SYSTEM.

- Saving of weighing data onto your assistant,
- Recipe programming,
- Integration and deletion of ingredients,
- Definition of feed batches,
- Management of leftovers,
- Mixing time per recipe programming,
- History of all data to compile your own consumption reports,
- User-friendly, intuitive navigation interfaces are compatible with everyday use.

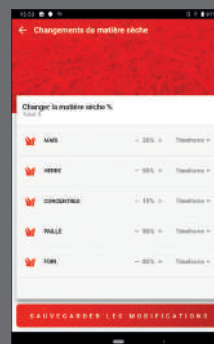

\* Weighing systems not available in all countries. For further information, contact your authorised KUHN partner.

# SPECIAL EQUIPMENT\*: CUSTOMISE YOUR MACHINE!

## A SCALABLE MACHINE TO ADAPT TO HERD SIZE AND RATION TYPE

### DEALING WITH AN EXPANDING HERD:

In order to cope with a growing herd, the KUHN PROFILE mixer wagons are designed to be scalable.

Just add bolt-on extensions to increase the mixing capacity of your PROFILE single or twin vertical auger mixer wagon. For example, by adding extensions to the PROFILE CROSSMIX 14.2 CS (14 m<sup>3</sup>), you convert it to a PROFILE CROSSMIX 20.2 CS (20 m<sup>3</sup>) with over 40% extra capacity!

Thanks to the auger design, an extension kit can be fitted to the body without compromising mixing quality, mixing speed and homogeneity or the strength of the tub: exclusive to KUHN!



### DEALING WITH NEW BUILDING LAYOUTS:

Modifications to a feeding table, installation of a new building, renovation of old cattle sheds: these are just some of the situations that can make your choice of equipment suddenly out-dated.

That's why the PROFILE range of mixer wagons is designed to be retrofitted with new distribution options like an offset cross-conveyor, tilting conveyors, hydraulic counter-knives and specially mounted knives.

Invest in the future with peace of mind!



### DIRECT CONTROLS

As standard, the PROFILE mixer wagons are controlled from the tractor's original distributors. Depending on the models, one or two double-acting valves are required on the tractor, and a double-acting valve is then required for each additional function.



### ANTI-OVERFLOW RING

For very fibre rich rations and/or for mixing whole bales, we advise you to fit your PROFILE mixer wagon with an anti-overflow system. Depending on the models, the anti-overflow ring is proposed as an option.

### HYDRAULIC COUNTER-KNIVES

For fibrous rations requiring more chopping, the version with two hydraulic counter-knives is best. You can extend and retract the counter-knives as needed from the tractor cab.



## METAL TRAP

### PLAY IT SAFE!

All the models in the PROFILE range can be fitted with a magnet on the mixing auger as an option. This system considerably reduces intestinal injuries caused by the ingestion of metal fragments contained in the fodder (barbed wire, scrap wire etc.).

\* The standard and optional equipment is not available in all countries. For further information, please contact your KUHN authorised dealer.



### ELECTRIC CONTROLS

The user-friendly electric system provides you with fingertip control of your machine. The small control box can be fitted in any type of tractor cab.



### ANTI-OVERFLOW EXTENSION

All the PROFILE models featuring extensions are fitted as standard with an anti-overflow extension. This prevents fibrous fodder from spilling over the sides during the chopping phase and protects the tub even if it gets hit by the loader during the loading phase.

### HATCH FOR ADDING MINERALS

Accuracy is important for ingredients that are added in small quantities. The PROFILE tub can be fitted with a hatch for adding mineral and vitamin supplements. With the safety grid and manual hatch door, you control the quantities that are added directly to the mix flow to achieve an even mixture.



It can be fitted on the double-bent scraper of the auger in the TMR flow and offers numerous advantages:

- The magnet is in contact with the fodder throughout the mixing phase.
- Regardless of your PROFILE mixer wagon's feed configuration, you are guaranteed a more effective result compared to magnets mounted on the tub discharge chute.

This high technology Neodymium-class magnet is ten times more effective than standard Ferrite-class magnets.

# INDUSTRIAL CONFIGURATION

## LONG LIFE SOLUTIONS!



In order to further minimise the wear and tear from abrasion and silage acidity, all the PROFILE models can be fitted with the K-NOX mixing augers as an option.

K-NOX greatly extends the service life of the auger, crucial to the performance of your mixer wagon:



All the auger parts (coils and cones) are made of K-NOX to protect the entire unit. These K-NOX augers offer superior resistance to friction and the fatty acids contained in silage.

K-NOX doubling plates can also be fitted to further improve this system exclusive to Kuhn. The doubling plates add a 4 mm layer of K-NOX to the bottom 80 cm of the tub walls.

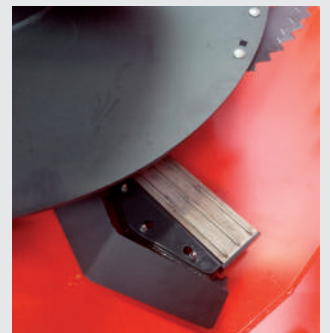
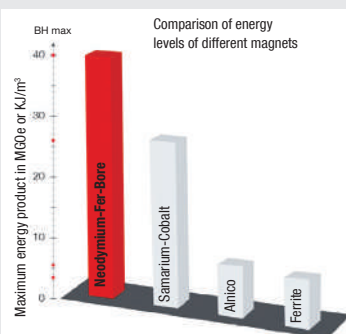
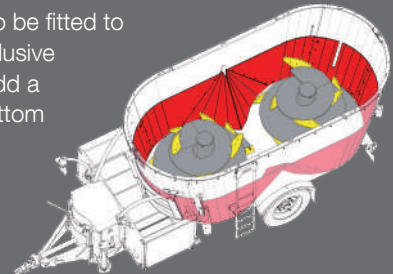

# Specifications

		DIRECT FEED MIXER WAGONS																											
		4.1 DS	6.1 DS	9.1 DL	10.1 DL	11.1 DL	12.1 DL	13.1 DL	14.1 DL	15.1 DL	12.2 DS	13.2 DS	14.2 DS	15.2 DS	16.2 DS	18.2 DS	20.2 DS	18.2 DL	20.2 DL	22.2 DL	24.2 DL	26.2 DL	28.2 DL	30.2 DL	34.2 DL				
Mixing capacity (m <sup>3</sup> )		4	6	9	10	11	12	13	14	15	12	13	14	15	16	18	20	18	20	22	24	26	28	30	34				
Number of vertical augers		1	1	1	1	1	1	1	1	1	2	2	2	2	2	2	2	2	2	2	2	2	2	2	2				
Distribution method		Direct feeding via side chute(s)																											
Straw blowing turbine		-																											
Overall dimensions (m)	Length	4.12	4.12	4.91	4.91	4.91	4.93	4.96	4.99	5.03	6.40	6.43	6.46	6.46	6.46	6.50	6.55	7.30	7.30	7.30	7.32	7.35	7.38	7.42	7.48				
	Width with standard equipment	2.21	2.24	2.79	2.79	2.79	2.80	2.81	2.82	2.84	2.42	2.42	2.42	2.42	2.42	2.44	2.44	2.76	2.76	2.76	2.77	2.78	2.80	2.81	2.86				
	Width with tilting conveyor (closed position)	2.42	2.42	2.92	2.92	2.92	2.92	2.92	2.92	2.92	2.53	2.53	2.53	2.53	2.53	2.53	2.53	2.92	2.92	2.92	2.92	2.92	2.92	2.92	2.92				
	Overall width across wheels	1.58	1.58	1.95	1.95	1.95	1.95	1.95	1.95	1.95	1.88	1.88	1.88	1.88	1.88	1.88	1.94	2.15	2.15	2.15	2.15	2.15	2.15	2.15	2.15				
	Height*	2.05 > 2.11	2.33 > 2.39	2.37 > 2.54	2.50 > 2.66	2.61 > 2.77	2.74 > 2.90	2.86 > 3.02	2.99 > 3.15	3.12 > 3.28	2.33 > 2.46	2.43 > 2.56	2.53 > 2.66	2.69 > 2.82	2.83 > 2.96	2.99 > 3.12	3.19 > 3.32	2.44 > 2.68	2.56 > 2.81	2.67 > 2.92	2.80 > 3.05	2.92 > 3.17	3.14 > 3.30	3.27 > 3.43	3.51 > 3.67				
Distribution height (mm)*	Distribution chute	560	560	536	536	536	536	536	536	536	550	550	550	550	550	550	440	698	698	698	698	698	744	744	744				
	Cross-conveyor	-	-	-	-	-	-	-	-	-	-	-	-	-	-	-	-	-	-	-	-	-	-	-	-				
	0.80 m tilting conveyor extended to 45°	880	880	1069	1069	1069	1069	1069	1069	1069	1120	1120	1120	1120	1120	1120	1010	1145	1145	1145	1145	1145	1191	1191	1191				
	1.10 m tilting conveyor extended to 45°	1090	1090	1285	1285	1285	1285	1285	1285	1285	1330	1330	1330	1330	1330	1330	1220	1335	1335	1335	1335	1335	1381	1381	1381				
Number of knives per auger / counter-knives	5/2	5/2	6/2	6/2	6/2	6/2	6/2	6/2	6/2	6/2	6/2	6/2	6/2	6/2	6/2	6/2	6/2	6/2	6/2	6/2	6/2	6/2	6/2	6/2					
Auger rotation speed (min <sup>-1</sup> )	29	29	29	29	29	29	29	29	29	29	29	29	29	29	29	29	29	29	29	29	29	29	29	29					
Tub bottom thickness / wall thickness (mm)	12/6	12/6	15/8	15/8	15/8	15/8	15/8	15/8	15/8	12/8	12/8	12/8	12/8	12/8	12/8	12/8	15/8	15/8	15/8	15/8	15/8	15/8	15/8	15/8					
Unladen weight (kg)	1840	2060	3860	3940	3970	4020	4070	4120	4190	5184	5265	5342	5452	5504	5592	5704	7412	7621	7663	7741	7805	7889	7975	8702					
Basic version control type		Direct from tractor's factory fitted distributor(s)																											
Type of axle with standard tyres		Single																						Bogie					
Tyre size on standard machine		10/75 - 15.3			400/60 - 15.5						435/50 R19.5						215/75 R17.5	455/40 R22.5											
Recommended tractor power (kW/hp)		29/40	33/45	44/60	48/65	51/70	55/75	59/80	59/80	63/85	55/75	55/75	59/80	59/80	63/85	66/90	70/95	66/90	70/95	73/100	81/110	85/115	88/120	92/125	95/130				
Minimum tractor hydraulics required for standard machine		1 DA																											
Required flow rate and pressure from tractor (l/min at 180 bar)		20-50																											

## EQUIPMENT\*\*

### Weighing equipment

Programmable weighing	◆	◆	◆	◆	◆	◆	◆	◆	◆	◆	◆	◆	◆	◆	◆	◆	◆	◆	◆	◆	◆	◆	◆	◆	◆
Assistant to manage the weighing (smartphone or tablet)	◇	◇	◇	◇	◇	◇	◇	◇	◇	◇	◇	◇	◇	◇	◇	◇	◇	◇	◇	◇	◇	◇	◇	◇	◇
Data transfer system	◇	◇	◇	◇	◇	◇	◇	◇	◇	◇	◇	◇	◇	◇	◇	◇	◇	◇	◇	◇	◇	◇	◇	◇	◇
Weighing system in the jack	-	-	◇	◇	◇	◇	◇	◇	◇	◇	◇	◇	◇	◇	◇	◇	◇	◇	◇	◇	◇	◇	◇	◇	◇

### Loading and chopping equipment

Anti-overflow ring	◇	◇	◇	-	-	-	-	-	-	◇	◇	◇	-	-	-	-	◇	-	-	-	-	-	-	-	-
Anti-overflow extension	-	-	-	◆	◆	◆	◆	◆	◆	-	-	-	◆	◆	◆	◆	-	◆	◆	◆	◆	◆	◆	◆	◆
Hydraulic counter-knives	-	-	◇	◇	◇	◇	◇	◇	◇	◇	◇	◇	◇	◇	◇	◇	◇	◇	◇	◇	◇	◇	◇	◇	◇
Hatch for adding minerals	◇	◇	◇	◇	◇	◇	◇	◇	◇	◇	◇	◇	◇	◇	◇	◇	◇	◇	◇	◇	◇	◇	◇	◇	◇
Auger magnet	◇	◇	◇	◇	◇	◇	◇	◇	◇	◇	◇	◇	◇	◇	◇	◇	◇	◇	◇	◇	◇	◇	◇	◇	◇
Auger knife coating	◇	◇	◇	◇	◇	◇	◇	◇	◇	◇	◇	◇	◇	◇	◇	◇	◇	◇	◇	◇	◇	◇	◇	◇	◇
K-NOX mixing auger	◇	◇	◇	◇	◇	◇	◇	◇	◇	◇	◇	◇	◇	◇	◇	◇	◇	◇	◇	◇	◇	◇	◇	◇	◇
K-NOX doubling plates (height 80 cm)	-	-	◇	◇	◇	◇	◇	◇	◇	◇	◇	◇	◇	◇	◇	◇	◇	◇	◇	◇	◇	◇	◇	◇	◇
Mix inspection ladder	◆	◆	◆	◆	◆	◆	◆	◆	◆	◆	◆	◆	◆	◆	◆	◆	◆	◆	◆	◆	◆	◆	◆	◆	◆

### Distribution equipment

1 door with right or left chute	◆	◆	◆	◆	◆	◆	◆	◆	◆	◆	◆	◆	◆	◆	◆	◆	◆	◆	◆	◆	◆	◆	◆	◆	◆
2 doors with chutes	◇	◇	◇	◇	◇	◇	◇	◇	◇	◇	◇	◇	◇	◇	◇	◇	◇	◇	◇	◇	◇	◇	◇	◇	◇
3 doors with chutes	-	-	-	-	-	-	-	-	-	◇	◇	◇	◇	◇	◇	◇	◇	◇	◇	◇	◇	◇	◇	◇	◇
4 doors with chutes	-	-	-	-	-	-	-	-	-	◇	◇	◇	◇	◇	◇	◇	◇	◇	◇	◇	◇	◇	◇	◇	◇
Central rear door	-	-	◇	◇	◇	◇	◇	◇	◇	-	-	◇	◇	◇	◇	◇	◇	◇	◇	◇	◇	◇	◇	◇	◇
Discharge conveyor 0.60 m	◇	◇	◇	◇	◇	◇	◇	◇	◇	◇	◇	◇	◇	◇	◇	◇	◇	◇	◇	◇	◇	◇	◇	◇	◇
Discharge conveyor 0.80 m	◇	◇	◇	◇	◇	◇	◇	◇	◇	◇	◇	◇	◇	◇	◇	◇	◇	◇	◇	◇	◇	◇	◇	◇	◇
Discharge conveyor 1.10 m	◇	◇	◇	◇	◇	◇	◇	◇	◇	◇	◇	◇	◇	◇	◇	◇	◇	◇	◇	◇	◇	◇	◇	◇	◇
Adjustment of the conveyor speed	◇	◇	◇	◇	◇	◇	◇	◇	◇	◇	◇	◇	◇	◇	◇	◇	◇	◇	◇	◇	◇	◇	◇	◇	◇

### Equipment for different tractors

Crank-operated jack	◆	◆	◆	◆	◆	◆	◆	◆	◆	◆	◆	◆	◆	◆	◆	◆	◆	◆	◆	◆	◆	◆	◆	◆	◆
Manual pump-operated jack	◇	◇	◇	◇	◇	◇	◇	◇	◇	◇	◇	◇	◇	◇	◇	◇	◇	◇	◇	◇	◇	◇	◇	◇	◇
Hydraulic jack with two-way cylinder	-	-	◇	◇	◇	◇	◇	◇	◇	◇	◇	◇	◇	◇	◇	◇	◇	◇	◇	◇	◇	◇	◇	◇	◇
Two-speed gearbox to reduce power requirement	-	-	◇	◇	◇	◇	◇	◇	◇	◇	◇	◇	◇	◇	◇	◇	◇	◇	◇	◇	◇	◇	◇	◇	◇
Output divider	◇	◇	◇	◇	◇	◇	◇	◇	◇	◇	◇	◇	◇	◇	◇	◇	◇	◇	◇	◇	◇	◇	◇	◇	◇
Road standard lighting and safety systems	◆	◆	◆	◆	◆	◆	◆	◆	◆	◆	◆	◆	◆	◆	◆	◆	◆	◆	◆	◆	◆	◆	◆	◆	◆

\* Varies depending on the tractor, tyres and equipment

\*\*Equipment varies with country







# TO SELECT, VIEW AND DISCOVER YOUR FUTURE MIXER WAGON IN DETAIL,

KUHN provides you with simple, user-friendly tools.

# HERE'S HOW IN JUST 6 EASY STEPS!



## CLICK & MIX APP

WORK OUT WHICH MIXER WAGON IS BEST FOR YOU

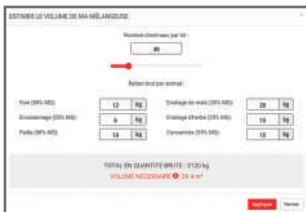

**1** ▶ FIGURE OUT WHAT CAPACITY YOU NEED

**2** ▶ SELECT THE FEATURES YOU NEED

**3** ▶ ENTER THE RELEVANT DIMENSIONS OF YOUR BUILDINGS

**4** ▶ DISCOVER THE MIXER WAGON MODELS BEST SUITED TO YOUR FARM



## CLICK & MIX VIEW APP

VIEW YOUR DISTRIBUTION EQUIPMENT

**5** ▶ SELECT YOUR MIXER WAGON MODEL



**6** ▶ SELECT AND VIEW THE DISTRIBUTION EQUIPMENT



DOWNLOAD THE FREE APP FROM



# ALL THE KUHN SOLUTIONS



1



2



3



4



5



- 1. Compact mixer wagons - 2. Standard mixer wagons
- 3. Self-propelled silage cutter/mixers - 4. Free-standing mixer wagons
- 5. Feeding Robot

To help choose the right mixing solution for you:  
[www.kuhn.com](http://www.kuhn.com)



## KUHN PARTS

### PARTS DESIGNED TO LAST

With our high-tech foundries and forges and state-of-the-art production facilities, KUHN manufactures spare parts that will last for years to come. You can really count on our expertise and our genuine parts. Thanks to our KUHN PARTS warehouses, you benefit from our customer support and our logistics services. We provide fast and reliable repair solutions, in cooperation with the KUHN Approved dealer nearest you.

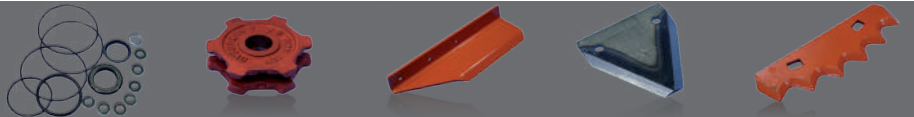

To find your nearest KUHN Approved Dealer, visit our website  
[www.kuhn.com](http://www.kuhn.com)

 <a href="http://www.kuhn.com">www.kuhn.com</a>	<p>Your Approved Partner</p>
---	------------------------------

**KUHN FARM MACHINERY (U.K.) LTD**  
 Stafford Park 7 - GB TELFORD/ SHROPS TF3 3BQ  
**KUHN FARM MACHINERY PTY. LTD**  
 313-325 Foleys Road - Deer Park, VIC, 3023 - AUSTRALIA  
**KUHN NORTH AMERICA, INC.**  
 1501 West Seventh Avenue - P.O. BOX 0167 - Brodhead, WI 53520 - USA

Information given in this document is only for information purposes and is non-contractual. Our machines are in compliance with regulations in force in the country of delivery. In our literature, and for improved illustration of certain details, some safety devices may not be in operating position. When operating these machines, these devices **must** be in position in accordance with the requirements indicated in the operator's manuals and pre-delivery instructions. RESPECT THE ROAD REGULATIONS IN FORCE AS WELL AS the tractor gross vehicle weight rating, its lift capacity and maximum load per axle and tyres. The tractor front AXLE load must always comply with the regulations of the country of delivery (In Europe, it must reach minimum 20 % of the tractor net weight). We reserve the right to change any designs, specifications or materials listed without further notice. Machines and equipment in this document can be covered by at least one patent and/or registered design. Trademarks cited in this document may be registered in one or several countries.

For more KUHN solutions, follow us on    