



AMAZONE

KE/KX/KG CombiDisc



Soil tillage implements from **AMAZONE**



Solo or in combination

Decide for yourself!



	Page
Soil tillage implements from AMAZONE	4
Rotary harrows and rotary cultivators	6
The models	8
Long-Life-Drive	10
Quick + Safe-System	12
Frame design Tines	14
KE rotary harrow	16
KX rotary cultivator	18
KG rotary cultivator	20
Robustness rotary cultivator	22
Equipment	24
Depth adjustment TL deep loosener	26
CombiDisc	28
Overview	30
Face seal and disc suspension	32
Adjustable wheel track discs and side discs Tractor wheel mark eradicators Depth setting	34
Rollers	36
Operation	40
“Liftpack” system	42
QuickLink quick coupling system	44
Technical data	46

Discover every possibility

With the KE rotary harrow, KG and KX rotary cultivators and the CombiDisc mounted compact disc harrow, AMAZONE offers you reliable soil tillage implements that precisely meet your requirements. Combined with your seed drill, or for solo use, the soil tillage implements stand for uncompromising reliability and quality like no other on the market.

With various models of roller available, it is possible to specify a complete unit of soil tillage and drill that are perfectly matched to the prevailing soil conditions.



CombiDisc



KE rotary harrow



KG rotary cultivator

KE rotary harrow and KX and KG rotary cultivators

The reliable, long-distance runner

With working widths from

2.5 m to 4 m



The advantages at a glance:

- ⊕ Comfortable adjustment via the universal setting tool
- ⊕ Easy setting of the levelling board – thanks to its guidance via the roller, no readjustment for the working depth is necessary
- ⊕ Simple and exact adjustment of the working depth via eccentric pins
- ⊕ Option: hydraulic working depth adjustment from the tractor cab
- ⊕ Spacious clearance between the tines and above the tine carriers – ideal for extreme amounts of straw
- ⊕ With Long-Life-Drive system, designed to withstand extreme loads and prolongs the service life
- ⊕ With Quick+Safe System – the proven quick tine change system with integrated stone safety protection
- ⊕ Robust design as the tine carrier and the shaft are forged from one piece
- ⊕ Maintenance-free, extremely resilient gearbox parts; oil-immersed for maximum protection
- ⊕ Highly strong due to the deep frame and the robust trough profile with double-skinned trough bottom
- ⊕ The versatile roller programme offers the right choice for any soil type

With **QuickLink**
quick coupling system

With
Long•Life•Drive

Quick-System
Quick tine change system

+ Safe-System
Integrated stone protection



The KE rotary harrows and KX and KG rotary cultivators in working widths from 2.5 m to 4 m are ideal for solo use or for use in combination with a catch crop seeder box for over-seeding. If equipped with the most appropriate roller, the ideal reconsolidation is achieved.

Rotary harrow or rotary cultivators

The all-rounder for seedbed preparation

Always the right choice:

Rotary harrows and rotary cultivators are still the best all-rounder when it comes to seedbed preparation. No other soil tillage implement can be used so flexibly on ploughed or unploughed ground. Used in combination with a rear mounted or harrow-mounted mounted seed drill, they are, for many farms, the ideal system solution.



D9 mounted seed drill with KE 3001 Super rotary harrow



Precea A precision air seeder with KG 3001 Special



Centaya 3000 harrow-mounted pneumatic drill with KG 3001 Super



Cataya harrow-mounted conventional drill with KG 3001 Super

- ✔ KG 3001 Special rotary cultivator with trapezium ring roller



- ✔ KG 3001 Super with track markers and with KWM 600 Matrix wedge ring roller in solo operation

Staggered tine layout guarantees smooth running

The tines on AMAZONE rotary harrows and rotary cultivators are set at a special angle in relation to each other. This guarantees an even soil crumbling and a smoother machine running. Incidents of vibration and peak loading are thereby prevented. The machines suffer less stress, and the power and fuel requirement is reduced.



AMAZONE: 10 tine carriers

- ✔ 10 tool carriers in a 3 m working width provide you with more free space, more robustness and better through passage

Long-Life-Drive

For all rotary harrows and rotary cultivators



The “extreme” stone test track

On the stone test track, all AMAZONE soil tillage implements are continuously tested under maximum load. This makes sure that you have the maximum of reliability with all AMAZONE rotary harrows and rotary cultivators.



VIDEO

www.amazone.net/Testtrack

Quality within the system

Long-Life-Drive is the optimised drive system for all AMAZONE rotary harrows and rotary cultivators that ensures an extended operating life, maximum smooth running and a high resale value. Gear wheels and bearings run in a single oil bath and so are maintenance-free – there are no grease nipples.

- ① Robust gearbox
- ② Highly-hardened spur gears with large teeth contact area
- ③ Exact spacing of all bearing seats for a maximum smooth running
- ④ Heavy-duty taper roller bearings with wide spacing between mounting points
- ⑤ Large clearance between tool carrier and smooth trough base for blockage-free mulch sowing and optimum though passage
- ⑥ Double sealing system with cassette sealing ring against oil loss and labyrinth seal against ingress of plant fibres and dirt
- ⑦ Tine carriers and shaft forged from one piece and with a large shaft diameter, KE rotary harrow $\varnothing = 45 \text{ mm}$ /
KG and KX rotary cultivator $\varnothing = 60 \text{ mm}$
- ⑧ Quick+Safe System with proven, tool-less tine change solution and integrated stone safety protection

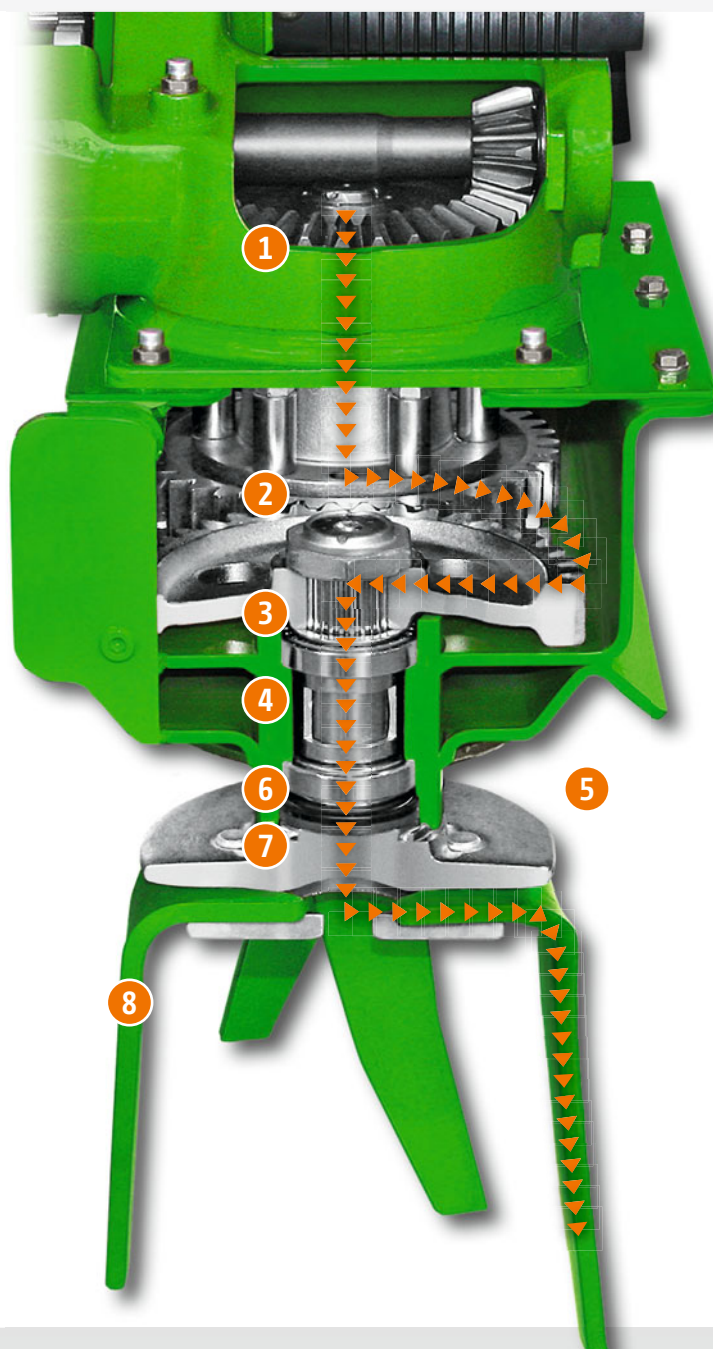

❗ “We really liked the handling of the rotary cultivator.”

(“profi” Practice test with Cataya 3000 Super till and drill combination · 07/2018)

Q+S-system Quick Safe

Across the KE, KX and KG – more than 75,000 satisfied customers



- ✔ In order to reduce wear on the lower link pins, they are equipped with an anti-rotation device

Quick-System

Quick change tine system

The tines are simply pushed into the sockets of the tine carrier and secured with a lynch pin. It couldn't be easier or quicker as there are no tine fixing bolts that require retightening. Even converting tine operation from "on-grip" to trailing mode is quick and simple. The tines, which are forged from special hardened steel, are elastic and wear-resistant.

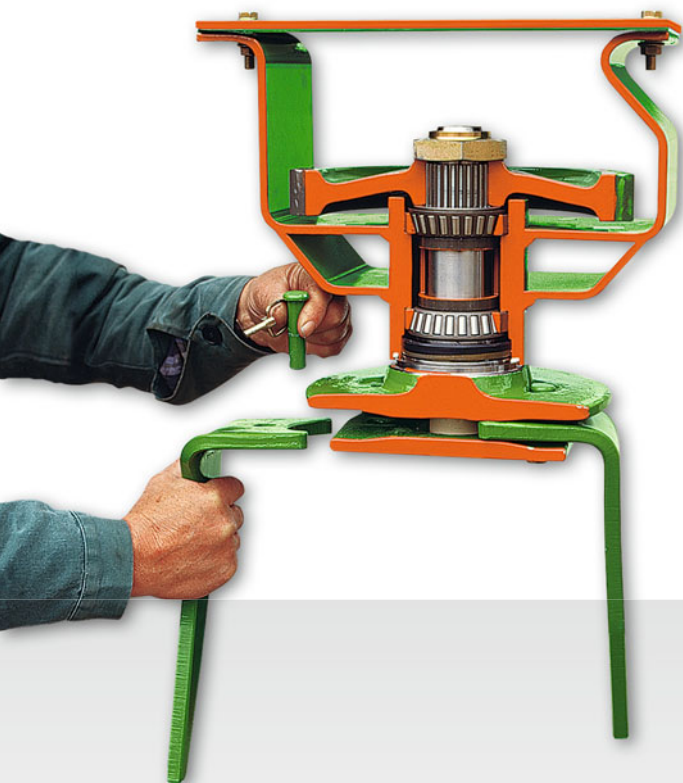

Safe-System

Integrated stone protection

The sprung tine fixing system allows the tines to yield when stones are encountered. The tines are firmly clamped in the socket in the centre of the tine carrier. The socket becomes wider towards the outside so that the horizontal part of the tine can twist out of position while remaining sprung. Much of the shock is absorbed when the tip of the tine hits a stone. This tine fixing system ensures the safe operation in stony soils and allows the tines on both the KX and KG to be used in the "on-grip" mode.

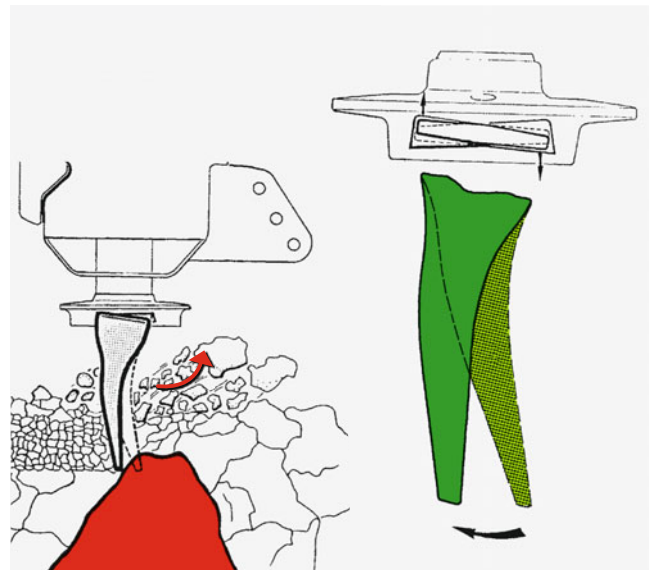

Superb rigidity yet plenty of room

Compare it for oneself!



KE tines



KX/KG tines
Trailing



KX/KG tines
"On-grip" Special



KG tines
"On-grip" Super



KX/KG
Potato tines

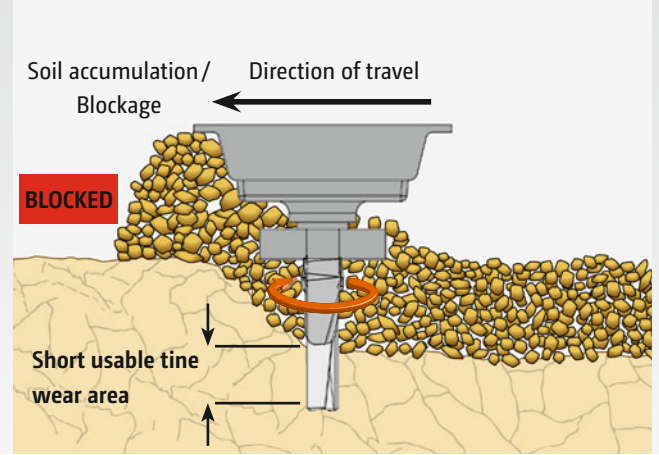
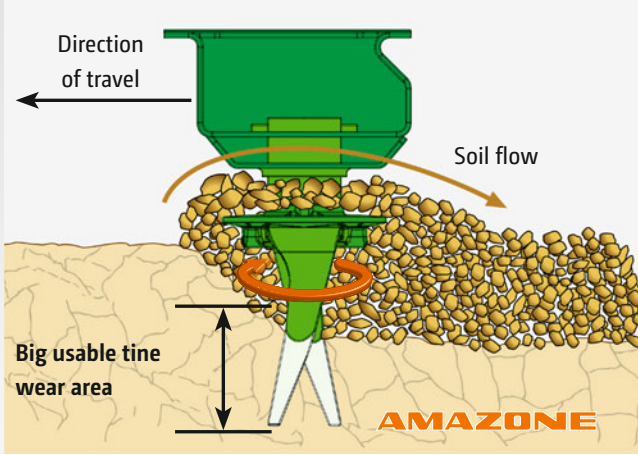

More clearance on the KE, KX and KG

The large frame depth, the completely smooth trough bottom without bearing housings and the long tines ensure the maximum clearance between the trough and the tine carriers. Even extremely large clods of soil or volumes of straw can therefore pass through without hindrance. The tines have a long service life, i.e. low wearing metal costs. An excellent seedbed structure is achieved that promotes the optimum field emergence of the young plants.

Incorporation effect

The AMAZONE rotary cultivator tines mix soil and straw evenly through the working depth. Even large amounts of organic residues are properly incorporated. For the KX and KG rotary cultivators, the best tine is available to suit any demand.

HD tines for an even longer life span

With the HD tine, AMAZONE offers a tine which, due to its hard metal coating, features an up to three times longer service life.

By using HD tines, running costs are minimised and, at the same time, valuable operating time for readjustment and tine changing is saved.

Tine wear in comparison

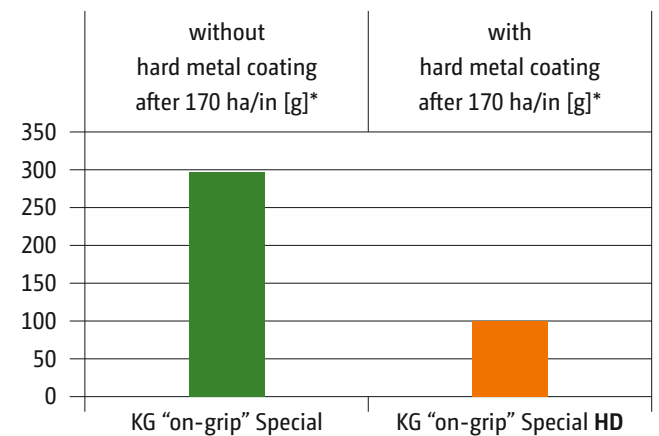

KX/KG tines
"On-grip" Special HD

* The tine wear depends on soil type, moisture content, operational speed, working depth, ...

KE rotary harrow – the strong lightweight!

KE rotary harrow – the reliable, long-distance runner

KE rotary harrows, in working widths of 2,5 m and 4 m, ensure, especially on light soils, a very good seedbed. Either in solo operation or in combination with a power harrow-mounted seed drill, a fine crumbled seedbed is achieved with the trailing tines.

KE 2501 Special

- ✔ for tractors up to 140 HP/102 kW

KE 3001 Special

- ✔ for tractors up to 140 HP/102 kW

KE 3001 Super

- ✔ for tractors up to 180 HP/135 kW

KE 4001 Super

- ✔ for tractors up to 180 HP/135 kW

KE 3001 Super



The benefits: KE Special and KE Super

- ✔ Fine-crumbled seedbed
- ✔ Easy rotor speed change by simply repositioning the bevel gears in the gearbox
- ✔ Light, handy and at the same time robust – thanks to the double-skinned trough design

Scale 1:1

The direct drive

A simple angle drive redirects the power only once and connects directly with the tine carriers.

- ✔ That saves fuel as fewer gear wheels mean less internal friction, less heat generation and less wear.
- ✔ The highest torques occur directly on the tine carrier shafts, resulting in an increased durability plus a high degree of safety and protection for the tractor.

Tine rotation speeds

540 rpm PTO shaft	750 rpm PTO shaft	1,000 rpm PTO shaft
152 rpm	212 rpm	282 rpm
200 rpm	280 rpm	373 rpm

- ✔ The tine carrier and the shaft are forged from one piece. With a shaft diameter of 45 mm.



KX rotary cultivator – the all-rounder



KX 3001 rotary cultivator

The KX rotary cultivator, in a working width of 3 m, is ideally suited for seedbed preparation on medium to heavy soils.

KX 3001
 ✔ for tractors up to
 190 HP/142 kW

Flexible and effective

With the KX rotary cultivator, in a 3 m working width and for tractors in the 190 HP class, a very flexible, usable PTO-driven soil tillage implement now exists that can be used as a rotary cultivator or as a rotary harrow.

Many farmers want to use a flexible machine for differing soil and operating conditions. That means, for example, a rotary cultivator with its “on-grip” tines for relatively heavy soils when mulch sowing and a rotary harrow with tines set to trailing mode on lighter, stony soils, so that the stones are pressed back down into the soil.

Previously, the tines have often simply been turned from “trailing” to “on-grip”. The finished result can then often be unsatisfactory, because only tines specially designed for each specific purpose can produce the best work.

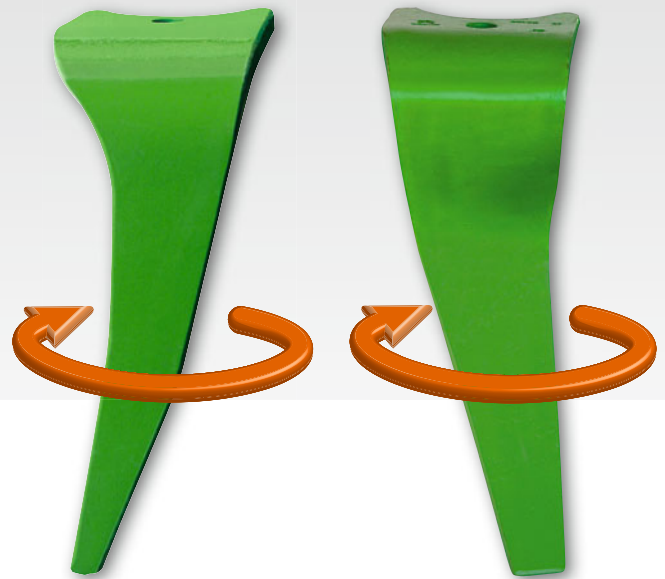

Tines “on-grip”

Tines in “trailing” mode

Quick change tine system

The proven tine quick-change system enables the KX to be converted without tools and in next to no time into a specialist machine which is suited to the particular ground conditions.

On both the rotary harrow and the rotary cultivator, the tines are simply pushed into sockets on the tine carriers. It couldn't be easier or quicker. There are no tine fixing bolts that require retightening.

With the rotary cultivator tines, the KX can be switched to the “on-grip” tine position, when heavy soil conditions are encountered. The “on-grip” position has proved itself the most ideal for mulch sowing, as an intensive mix of soil and organic residues is ensured.



The benefits of the rotary cultivator:

- ✔ Short set up times by the proven tine quick change system
- ✔ Very flexible in operation – can be, from choice, operated with trailing tines or with “on-grip” tines
- ✔ More rigidity – reinforced trough profile, thicker shaft diameter and stronger tines
- ✔ Loosening of hard and compacted soils without any problem
- ✔ Intensive incorporation of straw and other organic matter

KG rotary cultivator

KG Special rotary cultivator – the universal genius

The KG Special rotary cultivators, in working widths of 3 m, 3.5 m and 4 m, are ideally suited for seedbed preparation on heavy soils and for mulch sowing.

KG 3001 Special

✔ for tractors up to 220 HP/161 kW

KG 3501 Special

✔ for tractors up to 220 HP/161 kW

KG 4001 Special

✔ for tractors up to 220 HP/161 kW

KG Super rotary cultivator – the “muscle man”

The KG Super, in 3 m, 3.5 m and 4 m working widths, is equipped with a high capacity gearbox for tractor horse-powers of up to 300 HP. The KG Super has reinforced tines as standard and can be ordered with hydraulic depth adjustment and oil cooler as options.

KG 3001 Super

✔ for tractors up to 300 HP/220 kW

KG 3501 Super

✔ for tractors up to 300 HP/220 kW

KG 4001 Super

✔ for tractors up to 300 HP/220 kW



KG 3001 Special rotary cultivator



Tines "on-grip"

KG Special tines

KG Super tines

Rigidity is trumps!

Rotary cultivators from AMAZONE

Strong rotor carrier

The tine carrier and shaft are forged in one piece from high grade steel. The shaft diameter is a heavy-duty 60 mm.

The tine carrier shaft is supported by bearings with the optimum bearing spacing. Trough sealing is done with a special cassette seal with an optimum sealing effect and maximum service life. In addition, labyrinth seals prevent the ingress of plant fibres.

Robust trough

The high-standing 8 mm thick gear case made in a trough-type profile with double skin base and welded-in bearing sleeves is extremely torsion resistant, which enables it to easily withstand the high forces that occur when transporting heavy packer rollers and pack-top mounted seed drills without cumbersome external bracings. Spur gears and bearings are oil-immersed and thus maintenance-free – no grease nipples.

- ✔ Tine carrier and shaft are forged from one piece. The shaft diameter is 60 mm: strong as a bear.

Scale 1:1





Demixing effect of the rotary cultivator

The “on-grip” tine position has proved its effectiveness particularly when mulch sowing as it guarantees a thorough mixing of soil and organic residues.

Tines “on grip” break up the soil from underneath. No smeared layers. Coarse soil particles are thrown further than the light ones.

In this way the fine soil is concentrated in the lower range of the worked zone whereas the coarser soil particles remain on the surface. The seed is therefore placed in the area where the fine soil is collected with the coarser clods staying on the surface to protect the soil from capping, drying and wind and water erosion, and provide protection for young plants. This creates the optimum conditions for good seedling emergence.



KG rotary cultivator with “on-grip” tines

Levelling board

KW wedge ring roller

Equipment levels that delight!

For more efficiency and comfort on all rotary harrows and rotary cultivators



KG 3001 Super rotary cultivator with Precea 3000 AC precision air seeder

Oil cooler

Continuous operation, even under very hot climatic conditions, is no problem for KG* rotary cultivators thanks to the optional oil cooler.

*Only available for the KG Super models: KG 3501 and KG 4001.

Tractor wheel mark eradicators

For operation on compaction-sensitive soils and at a reduced working depth, the optionally available tractor wheel mark eradicators make sense. The position of the wheel mark eradicators can be adjusted horizontally and vertically. The overload safety device ensures a constant trip force. The narrow, diamond and wing shares are available as soil-engaging points.





❗ “The roller now guides the levelling board for height. So, readjustment is not necessary when the rotary cultivator is allowed to work deeper.”

(“dlz agrar magazine” Mechanics meets Electronics · 01/2017)

Levelling board

The levelling board levels the earth flow between the tines and the roller and presses obstacles downwards. With the universal operating tool, the height of the levelling board can be adjusted with ease.

The benefits:

- ✔ Independent height control parallel to the roller
- ✔ Integrated overload safety protection allows for upward evasion
- ✔ Optionally, the levelling board can also be left out

Lights for road travel

The rotary harrows and rotary cultivators meet all the requirements for safe transport on the road with front and rear lighting.

Track markers on the soil tillage implement

When using the optional track markers, we recommend mounting them directly on the implement. The forward-mounting position not only optimises the centre of gravity of the implement, but also allows it to be used solo operation.



❗ “The depth of the lower wear plate can be comfortably readjusted: Slacken the bolts and push the plate into the desired “notch”, retighten bolts – finished.”

(“dlz agrar magazine” Test report Cataya Super · 01/2017)

Side plates

The newly-developed side plates are sprung loaded. Thanks to their suspension, the side plates can be adjusted via a slotted hole and, when worn, be simply exchanged. The universal setting tool supplied as standard is all that is necessary to make the adjustment.

The benefits:

- ✔ Convenient depth adjustment
- ✔ The spring-loaded guidance makes upward evasion possible



Working depth adjustment – precise and comfortable

Mechanical depth adjustment

The parallel guidance of the roller and the levelling board allows the very easy and independent setting of the working depth. By the simple repositioning of the eccentric pin, the working depth can be conveniently matched to the field and operational conditions.

KX/KG hydraulic depth adjustment

The optionally available hydraulic depth adjustment for the KX/KG rotary cultivator offers the driver even more comfort and operational possibilities than before, as now, the levelling board is guided in parallel via the roller and so does not require any readjustment when changing the working depth.

If required, for instance when working deeper on the headland, the rotary cultivator can be steplessly adjusted comfortably from the tractor cab. So any change in soil conditions can be directly responded to and the optimum quality of work maintained.



✔ KX/KG hydraulic depth adjustment



✔ Mechanical depth adjustment



✔ Parallel guidance of the roller

Deep loosening

All in one operation

TL 3001 deep loosener

The compact TL deep loosener, with its 4 tines, makes it possible to loosen the soil down to a depth of 25 cm. With this system, AMAZONE offer the option of plough-less cultivation, even where a high level of straw prevails. Plough-less cultivation in one pass prevents soil compaction in the sowing horizon.

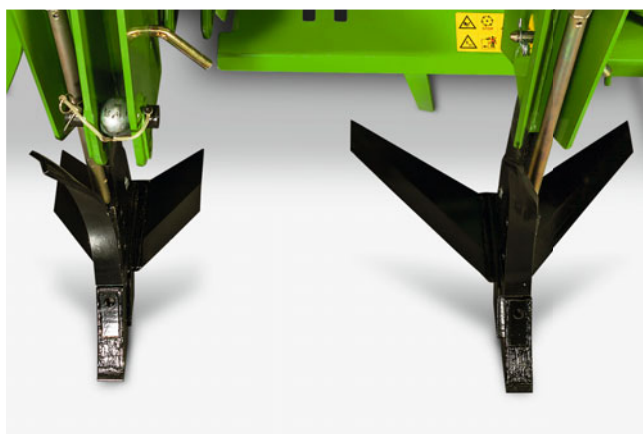

- ✔ As standard, 30 cm wing shares are used but, as an option, a wider loosening 60 cm wing share and a side plate extension are available.

	TL 3001 deep loosener
Working width (m)	3.00
Transport width (m)	3.00
Number of deep loosening legs	4
Width of the wing share (cm)	30 (60 cm option as a loose supplied part)
Frame height (mm)	1,000
Weight (kg)	494

CombiDisc

The quick and easy-pulling compact disc harrow

In a **3 m** working width

Working depth of
3 cm to 8 cm



The advantages at a glance:

- ⊕ Easy to pull with operational speeds up to 15 km/h
- ⊕ Cost effective alternative to the rotary harrow on light soils
- ⊕ Short, compact and light design – also suitable for smaller tractors
- ⊕ Simple soil tillage from 3 cm to 8 cm working depth for the optimum seedbed preparation
- ⊕ Maintenance-free disc bearings with slide seals and life-long lubrication
- ⊕ Maintenance-free stone safety protection via rubber sprung buffer blocks
- ⊕ Disc suspension in pairs – for optimised contour following and excellent through passage
- ⊕ Hydraulic working depth adjustment is available
- ⊕ Very easy, quick and tool-less change of the soil tillage implement thanks to the QuickLink quick coupling system

Up to **15 km/h**
working speed

With **410 mm discs**
serrated



The mounted CombiDisc compact disc harrow in its 3 m working width is ideally suited to high forward speeds, especially when sowing with a harrow-mounted seed drill. With working depths of 3 cm to 8 cm, an optimum seedbed is created. The wide roller programme offers for any soil type the most suitable roller for the optimum reconsolidation.

CombiDisc

compact – easy to pull – highly efficient



CombiDisc 3000 with the Centaya 3000 Super harrow-mounted seed drill

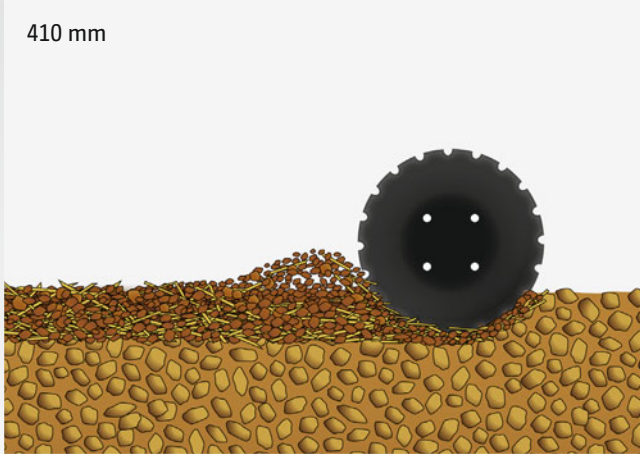

CombiDisc discs, 4 mm thick, 410 mm diameter (fine serrated)



CombiDisc in solo operation

High output

The 24 serrated discs, each with a diameter of 410 mm, provide an intensive soil tillage. The CombiDisc can operate at working depths of 3 cm to 8 cm. Thanks to its easy pulling, operational speeds up to 15 km/h are possible. Especially on light soil types, the CombiDisc is an efficient and good alternative to the rotary harrow.

Benefits of the CombiDisc discs

- ✔ Very shallow soil tillage with working depths of 3 cm to 8 cm
- ✔ Optimised for seedbed preparation

CombiDisc discs – extremely shallow, extremely easy to pull

The 410 mm diameter discs of the CombiDisc are the ideal solution for the extremely shallow and intensively mixing soil tillage. Due to the small disc diameter, a high disc revolution speed is achieved ensuring a very good crumbling effect. Especially on light to medium soils, the CombiDisc, in combination with a harrow-mounted seed drill, ensures the optimum seedbed.

QuickLink – quickly combined, flexible in operation

The QuickLink quick coupling system allows the easy separation of CombiDisc with a few hand clamps so that the mounted compact disc harrow can also be used in solo operation for seedbed preparation.



CombiDisc 3000 with Cataya 3000 Super harrow-mounted seed drill



CombiDisc 3000 with the Centaya 3000 Super semi-mounted seed drill

Maintenance-free face seal

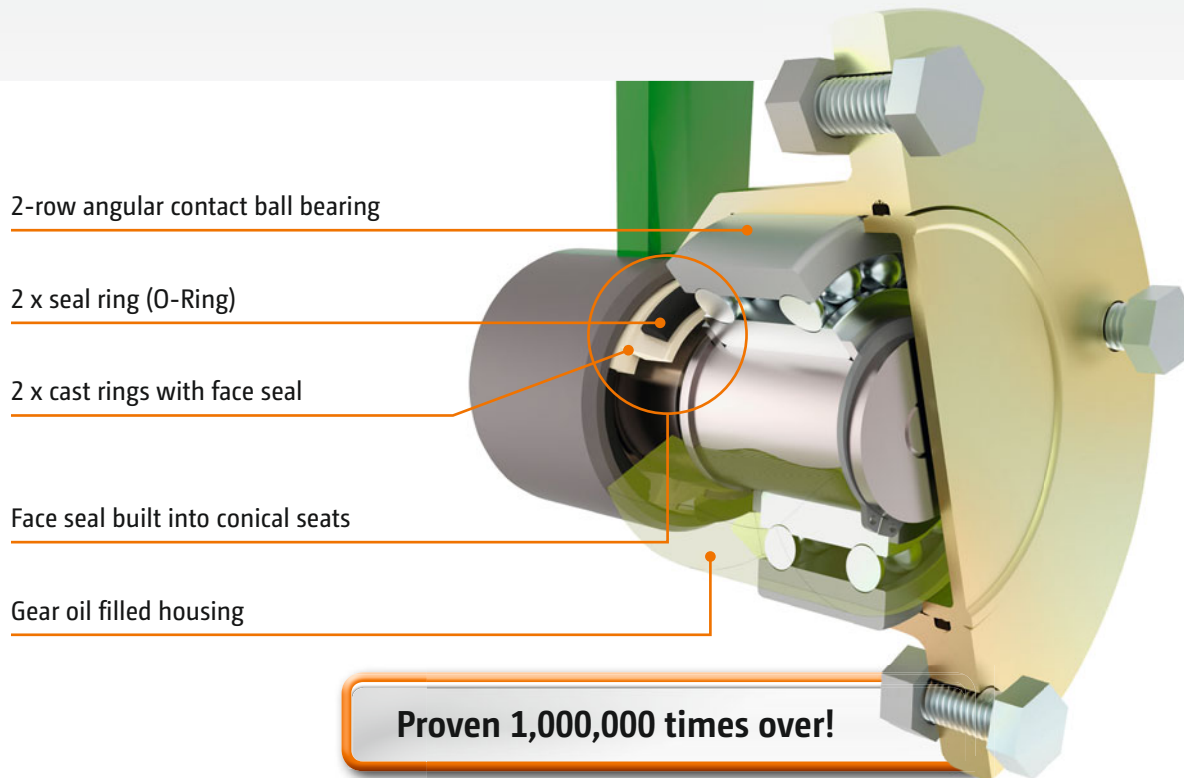

No lubrication ever again – thanks to the maintenance-free disc bearings

With no need to lubricate the disc bearings, this results in a significantly reduced overall maintenance time. Face seals have been used for decades in road construction equipment where the rollers on the running gear of caterpillar-tracked vehicles have to be effectively sealed and continue to work absolutely reliably under the toughest of operational conditions.

The benefits

- ✔ Maintenance-free disc bearings with slide seals and life-long lubrication
- ✔ Maintenance-free stone safety protection via rubber sprung buffer blocks
- ✔ Disc suspension in pairs for optimised soil contour following and a very good through passage

Reliable disc suspension

Aggressively angled discs for the optimum seedbed preparation

The 2-row disc harrow loosens, crumbles and levels the seedbed prior to the seed placement. The discs of the CombiDisc are aggressively angled, 14° at the front disc row and 12° at the rear disc row. This angle ensures the optimum levelling of the seedbed. In conservation tillage, the straw near the surface is additionally further distributed and mixed. In this case the disc position ensures the flowing transition of the soil-straw mixture from the first to the second disc row and results in a good mixing.



Perfect – for the optimum soil contour following

Thanks to the disc suspension in pairs via elastic rubber sprung elements on the frame, the each double set of discs are able to follow the ground contours individually. In this way, a very consistent, shallow soil tillage can be carried out even with undulations in the soil surface. The suspension of the discs at the same time allows the optimum through passage of large amounts of organic matter.

Safe and absolutely maintenance-free!

The elastic rubber sprung elements suspending the discs not only serve as an optimum matching to the ground contours but also act as an overload safety device for the individual pairs of discs. The oversized rubber buffers are maintenance-free and are characterised by a large spring deflection providing safety even where large stones prevail.

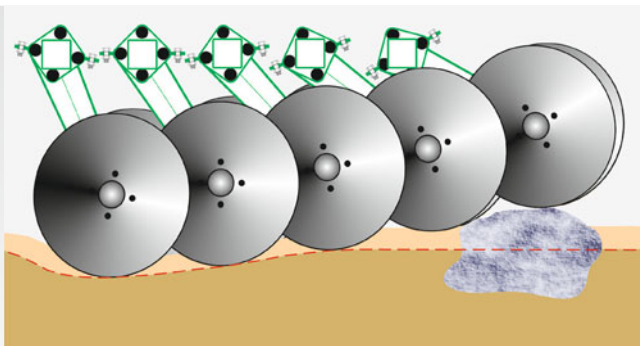

- ✔ Practically orientated down to the last detail: Contour following of the individual disc segments and with built-in overload and stone protection



For the best results

Perfectly matched to your application. And to your soil!



- ✔ The telescopic side plates ensure the optimum bout following and can, for road transport, be put into the transport position quickly, simply and without tools.



Adjustable wheel track and side discs

The CombiDisc features wheel track and side discs that are individually adjustable in their height to ensure an optimum cultivation and a consistent seedbed even in the tractor tracks and at the outer edges.

Tractor wheel mark eradicators

For operation on compaction-sensitive soils and at a reduced working depth, the optionally available tractor wheel mark eradicators make sense. They loosen the packed wheel tracks behind the tractor tyres. The position of the wheel mark eradicator can be adjusted horizontally and vertically. Depending on soil type and application of the machine, the wheel mark eradicator can be equipped with different loosening shares. The overload safety device provides a maintained release force in all positions.

Mechanical depth adjustment

Via the stepless mechanical depth adjustment, the Combi-Disc can be matched very quickly and simply to the relevant application. With the mounted compact disc harrow you only need to operate as deep as necessary – thus saving fuel.

Hydraulic depth adjustment

In addition, a comfortable hydraulic working depth adjustment is available enabling the easy and precise setting from the tractor cab. Easily visible and with a large scale for orientation allowing operation in the field to be as shallow as necessary and yet conveniently deeper on the headland and in any tracks.

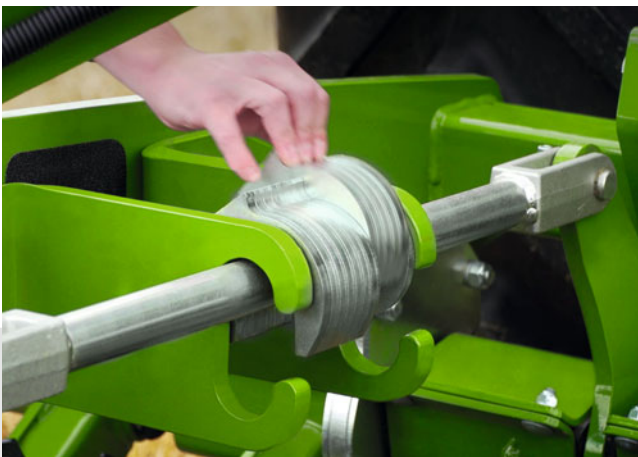

✔ Working depth adjustment via spacers – here at a shallow working depth

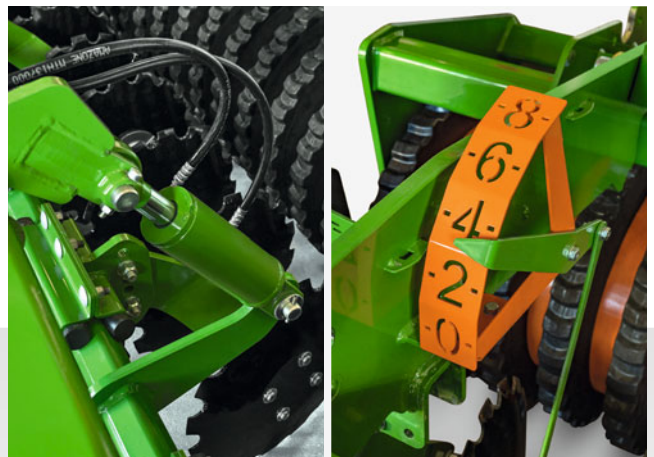

✔ Hydraulic depth adjustment with large scale

Wide roller programme –

for any location the right roller

Decide for yourself

The most important task of a roller is reconsolidation. Due to the many possible challenges (seed/soil conditions/lifting power of the tractor) a large variety of different rollers is therefore available. So, the right roller can be chosen for any seed and for any soil type. As the harrow-mounted seed drill rests directly on the roller, the total weight is safely carried and thus the optimum performance is ensured.

Enclosed roller

In general: on loose and light soils solid rollers carry better than open rollers. In addition, solid rollers tend to less blockage. Exactly for this reason on the wedge ring and Matrix wedge ring rollers, the rubber rings are fitted to an enclosed tube. When the rings sink into the loose soil, the tube carries the weight across the entire length.

There is no chance of sticking, clogging or blocking up.

Large diameter

Rollers with a large diameter carry the drill better because the weight rests on a larger contact surface and moreover they run significantly smoother than rollers with a small diameter. Therefore AMAZONE rollers feature large diameters from 500 mm to 600 mm. These advantages become obvious especially at higher sowing speeds and yet an exact seed placement.

Robust steel roller body

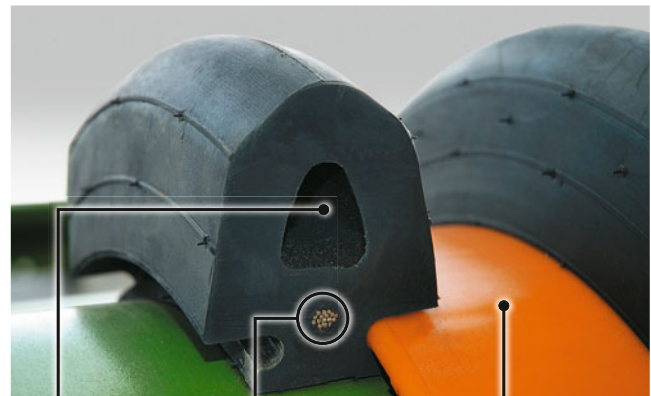

Air cushion
shock absorber

Metal insert
for maximum
ruggedness and
a perfect fit

Spacer ring
with dirt-
repellent
surface

The targeted reconsolidation –

for best plant growth and higher yields!

Reconsolidation in strips

Due to the reconsolidation in strips, it is possible to create optimum soil conditions which match to the current weather conditions and thus ensures the precondition for quick and even plant growth. This means that reconsolidation in strips is an insurance for timely cultivation. In addition, homogeneous and well reconsolidated strips without a cleat imprint are left. In comparison to rollers with an all-over profile, this is a decisive advantage which, above all, has an effect on the smooth running of the sowing coulters.

Sowing insurance!

- 1) **In severe drought – principle of a water pump:**
The re-consolidated strips provide soil contact directly in the seed furrow. In this way, capillary water reaches the seedling even in dry weather. The re-consolidation in strips ensures that your soil works as a water pump.
- 2) **In much wetness – principle of drainage:**
The loose soil absorbs any rain well and stores it. Rain from heavy downpours simply soaks into the unrolled, loose areas and so soil erosion is prevented. In this case, your soil works like a drain. Even at heavy, wet soils there is enough loose soil available between the rows to cover the seed with loose soil.
- 3) **Gaseous exchange – the lungs principle:**
The loose soil also enables gases to be exchanged, so that the roots can breathe.



The roller programme

Not too much and not too little – localised reconsolidation

SW cage roller

520 mm Ø

The SW cage roller is a reliable, inexpensive entry-level roller with a particularly low weight. Reconsolidation takes place transverse to the direction of travel with good crumbling and an open surface structure.

- ✔ Reconsolidation with depth effect
- ✔ Extremely lightweight entry-level roller, especially suitable for smaller tractors
- ✔ Good crumbling and a guaranteed self-driving effect



PW tooth packer roller

500 / 600 mm Ø

The PW tooth packer roller features a good self-driving effect and, with its leading teeth, it performs a good reconsolidation all across the whole surface. Due to its performance, the tooth packer roller is universally usable.

- ✔ Consolidation is fully over the entire soil surface
- ✔ Runs blockage-free on sticky soils and where there is a lot of straw
- ✔ As standard with hard metal coated, wear resistant scrapers
- ✔ Low set scrapers ensure a smooth surface even in wet soil conditions

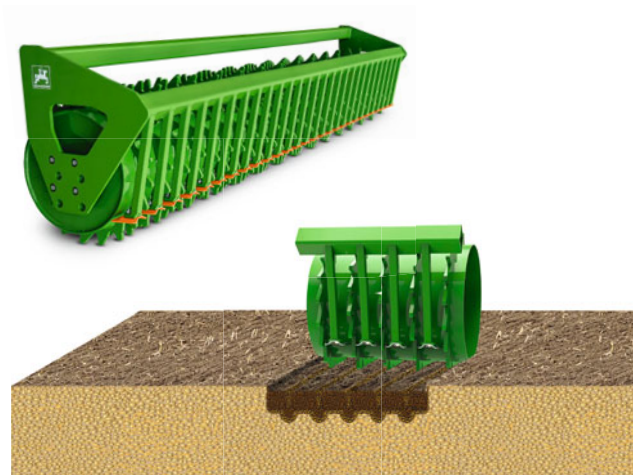

TRW trapezium roller

500 mm / 600 mm Ø

With its trapezium rings, the TRW trapezium roller provides a reconsolidation in strips. Due to its good carrying ability, the trapezium rings on light soils are prevented from sinking in too deep.

- ✔ Good carrying ability
- ✔ Reconsolidation in strips
- ✔ Sufficient fine earth
- ✔ As standard with hard metal coated, wear resistant scrapers

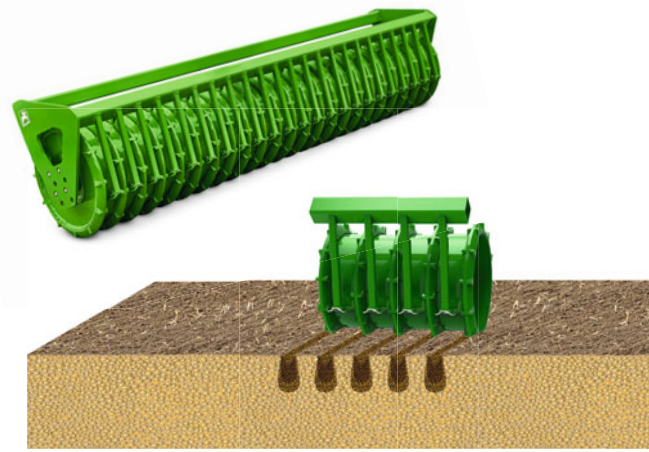

KW wedge ring roller

520 mm / 580 mm Ø

The KW wedge ring roller benefits from a wide range of applications. Due to its design, the strip-wise reconsolidation is ensured in virtually all soils and under any conditions. The sticking of any dirt, capping or blockages are not an issue!

- ✔ Universal for all soils and conditions
- ✔ Reconsolidation in strips
- ✔ Even in heavy soils, sufficient loose earth is available for the optimum seed coverage
- ✔ Very well suited to any weather, no matter whether moist or dry
- ✔ Smooth coulter travel due to the pre-formed seed furrow

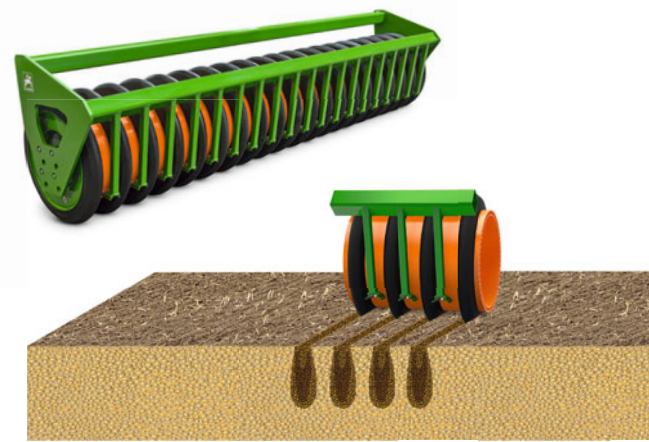

KWM wedge ring roller with Matrix tyre profile

600 mm Ø

The KWM wedge ring roller, with its Matrix tyre profile, features an especially good self-driving ability and, with its Matrix tyre profile, the roller produces more fine soil for the seedbed.

- ✔ Reconsolidation in strips
- ✔ Matrix tyre profile for improved self-drive ability
- ✔ Improved crumbling even under tough conditions
- ✔ Smooth coulter travel due to the pre-formed seed furrow
- ✔ Very well suited to any weather, no matter whether moist or dry

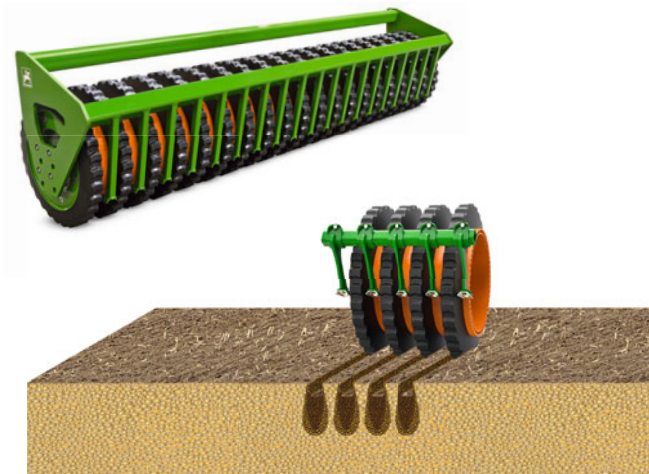

Always the right choice!



Thanks to the "Liftpack" system and the QuickLink quick coupling system, a wide variety of sowing systems can be combined



✔ Universal setting tool

Universal setting tool – the tool for every need

The universal setting tool is the ideal solution that avoids the transportation of and the troublesome searching for more than one spanner. Irrespective of whether just the soil

tillage implement or the seed drill as well is being used, the universal operating tool promises convenient operation.

GreenDrill 200 universal catch crop seeder box

The GreenDrill catch crop seeder box is the ideal solution for sowing catch crops or reseeding in a single pass. The GreenDrill seed hopper has a capacity of 200 litres. The seed is distributed across the full width using baffle plates. In the metering system below the seed hopper, a seed shaft is fitted with normal or fine seed wheels depending on the seed type and desired application rate.

The benefits

- ✔ Sowing catch crops and fine seeds simultaneously with stubble cultivation or soil tillage
- ✔ Various metering cassettes available
- ✔ Wide distribution via baffle plates
- ✔ Easily filling via access steps
- ✔ Modern operator station in two equipment levels



✔ Baffle plates

✔ The in-cab terminal 5.2 is available for controlling the seeder box

For the best results

With the “Liftpack” system and the QuickLink quick coupling system

Clever and simple

Thanks to the “Liftpack” and QuickLink quick coupling systems from AMAZONE, seed drills can be easily connected to the various soil tillage implements without the need for tools.

In this way, sowing combinations can be optimally matched for different soils and requirements.

The options

Soil tillage implement

- ✔ KE rotary harrow
- ✔ KX/KG rotary cultivator
- ✔ CombiDisc mounted compact disc harrow¹

with roller

- ✔ SW cage roller
- ✔ PW tooth packer roller
- ✔ TRW trapezium roller
- ✔ KW wedge ring roller or
- ✔ KWM wedge ring roller with Matrix tyre profile



Harrow-mounted seed drill

- ✔ Centaya²
- ✔ AD-P Special
- ✔ Cataya
- ✔ AD
- ✔ Precea A²

or mounted seed drill

- ✔ D9

¹ Combination possible only with the Cataya and Centaya harrow-mounted drills and PW 600, TRW 500/600, KW 580 and KWM 600 rollers

² Combination possible only with the KX and KG rotary cultivators



KG 3001 Super rotary cultivator with QuickLink and uncoupled Cataya 3000 Super harrow-mounted seed drill



KE 3001 Super rotary harrow with “Liftpack” system and D9 3000 linkage mounted seed drill



✔ Optional coupling parts

The “Liftpack” system for D9 mounted seed drill

The AMAZONE “Liftpack” system enables the combination of the D9 mounted seed drill with a soil tillage implement. With this combination, seedbed preparation and sowing is done in a single pass. Setup is carried out without the need for any tools, in a few simple steps.

Coupling parts for rigid mounting

As an option, rigid coupling parts for the rotary harrow and rotary cultivator are available for the simple attachment to a soil tillage implement.

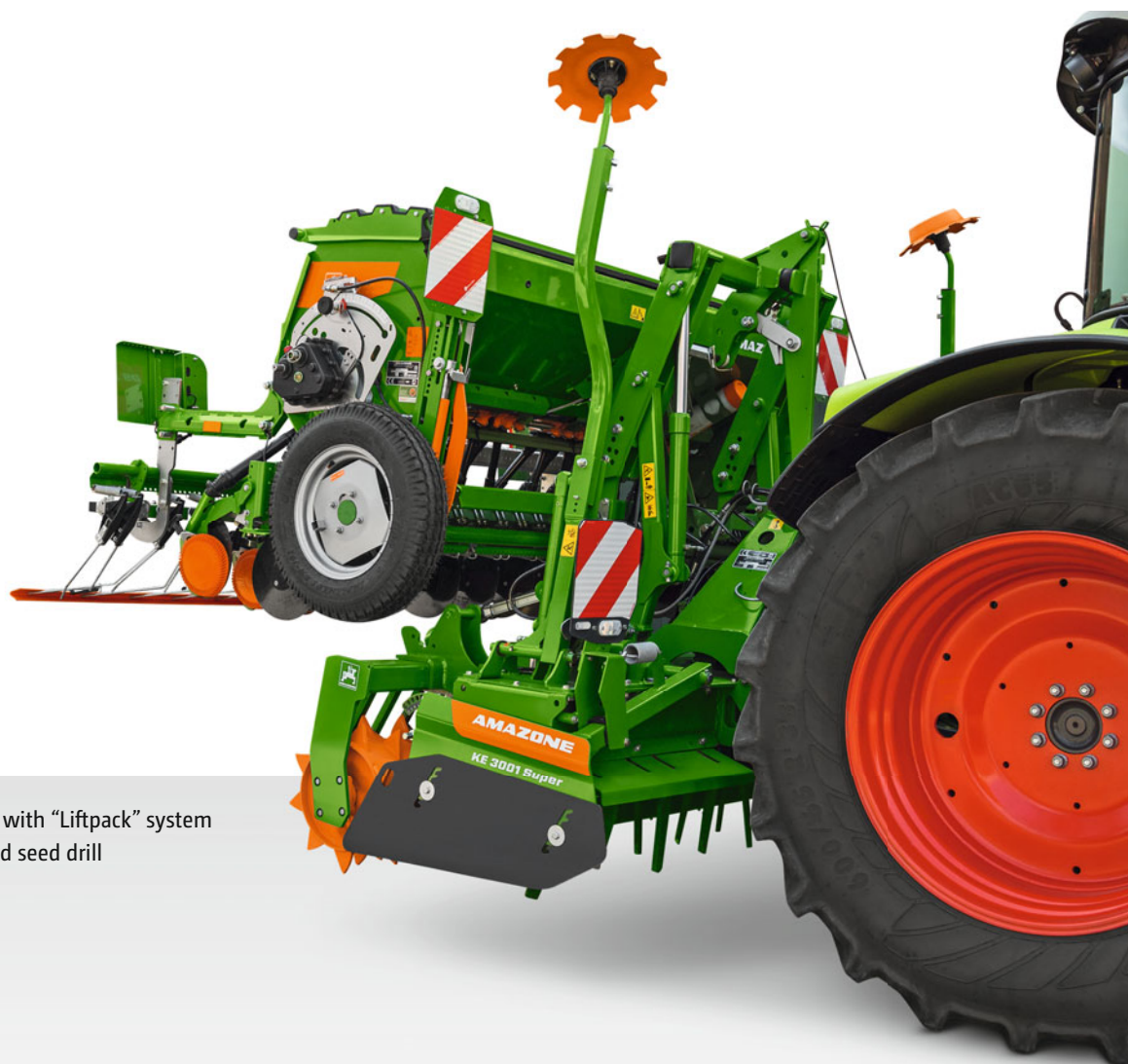

KE 3001 Super rotary harrow with “Liftpack” system and D9 3000 linkage mounted seed drill

QuickLink quick coupling system

for AD, AD-P, Cataya, Centaya and Precea A harrow-mounted drills and seeders

Thanks to the intelligent QuickLink quick-coupling system for all harrow-mounted drills and seeders, the sowing combination can be separated with ease in just a few minutes. The three easily accessible coupling points of the QuickLink system ensure a safe, tool-free and fast coupling and uncoupling process. So, the soil tillage implement can also be utilised perfectly for solo operation.



✓ AD-P Special 01

Parking supports

To enable the utilisation of the soil tillage implement as a solo machine, AMAZONE offers the optional parking stands for the simple and quick uncoupling of the harrow-mounted seed drill. In this way the machine is very quickly dismantled and mounted.



✓ Precea A



✔ Cataya



✔ Centaya



✔ Quick coupling system QuickLink – for simple, fast and tool-free coupling and uncoupling



✔ CombiDisc mounted compact disc harrow



✔ KE rotary harrow
✔ KX/KG rotary cultivator

Technical data



CombiDisc 3000 mounted compact disc harrow

CombiDisc mounted compact disc harrow

Model	Working width (m)	Transport width (m)	Power requirement from (kW/HP)	For tractor output up to (kW/HP)	Number of tine carriers	Basic weight without roller from (kg)	Basic weight with roller KW 580 from (kg)
CombiDisc 3000	3.00	3.00	59/80	205/280	24	880	1,425



KG 3001 rotary cultivator

KE rotary harrows and KX/KG rotary cultivators

Model	Working width (m)	Transport width (m)	Power requirement (kW/HP)	For tractor output up to (kW/HP)	Number of tine carriers	Basic weight without roller (kg)	Basic weight with roller KW 580 from (kg)
KE 2501 Special	2,50	2,50	40/55	102/140	8	995	— ¹
KE 3001 Special	3.00	3.00	48/65	102/140	10	1,060	1,679
KE 3001 Super	3.00	3.00	59/80	135/180	10	1,120	1,739
KE 3501 Super	3.50	3.50	63/85	135/180	12	1,120	1,799
KE 4001 Super	4.00	4.03	66/90	135/180	14	1,330	1,949
KX 3001	3.00	3.00	66/90	142/190	10	1,350	1,969
KG 3001 Special	3.00	3.00	66/90	161/220	10	1,340	1,959
KG 3501 Special	3.50	3.50	77/105	161/220	12	1,450	2,029
KG 4001 Special	4.00	4.03	88/120	161/220	14	1,580	2,199
KG 3001 Super	3.00	3.00	66/90	220/300	10	1,360	1,979
KG 3501 Super	3.50	3.50	77/105	220/300	12	1,480	2,059
KG 4001 Super	4.00	4.12	88/120	220/300	14	1,610	2,229

¹Only available with PW tooth packer roller

Following rollers

Model	Cage roller		Tooth packer roller						Trapezium ring roller						Wedge ring roller			KWM 600 wedge ring roller with Matrix tyre profile			
	PW 520	PW 400	PW 500	PW 600	TRW 500	TRW 600	KW 520*	KW 580	TRW 500	TRW 600	KW 520*	KW 580	TRW 500	TRW 600	KW 520*	KW 580	TRW 500	TRW 600	KW 520*	KW 580	
Working width (m)	3.00	4.00	2,50	3,00	4,00	3,00	3,50	4,00	3,00	3,50	4,00	3,00	3,50	4,00	3,00	3,00	3,50	4,00	3,00	3,50	4,00
Diameter (mm)	520		500			600			500			600			520	580			600		
Basic weight from (kg)																					
with 12.5 cm row spacing	—	—	—	—	—	—	—	—	534	612	—	638	733	828	339	521	593	668	529	606	669
with 14.6 cm row spacing	—	—	—	—	—	—	—	—	572	—	—	692	—	—	—	—	567	—	—	578	—
with 15.0 cm row spacing	280	359	327	385	500	521	598	675	494	—	—	592	—	—	—	481	—	—	500	—	—
with 15.4 cm row spacing	—	—	—	—	—	—	—	—	—	—	—	—	—	759	—	—	—	603	—	—	638

*only for row spacings of 12.5 cm and a working width of 3 m

Illustrations, content and technical data are not binding! Technical data may deviate according to the level of equipment. Machine illustrations can vary due to country-specific traffic legislation.



AMAZONE



Illustrations, content and technical data are not binding! Technical data may deviate according to the level of equipment.
Machine illustrations can vary due to country-specific traffic legislation.



AMAZONEN-WERKE H. Dreyer GmbH & Co. KG
P. O. Box 51 · 49202 Hasbergen-Gaste/Germany
Phone +49 (0)5405 501-0 · Fax +49 (0)5405 501-193