

PRIMOR

2060 m - 3570 m - 5570 m

Straw Blowers & Feeders



QUALITY MACHINE POWER FOR OPTIMUM DISTRIBUTION OF LONG-STRANDED PRODUCTS



The PRIMOR range: the right choice!

The versatility of ration feeding equipment is a decisive factor in keeping ahead of changes in livestock fodder. Farmers increasingly take into account the notions of user friendliness, time savings and quality of life into their investment decisions. These considerations have all been taken on board in the development of the PRIMOR straw blower and all-fodder feeder range:

▶ Machines which are easy to load thanks to the hydraulically-powered tailgate which rests on the ground. Loading capacities of up to three round bales with a diameter of 1.50 m (4' 11") to considerably cut down on the unproductive time spent travelling to and for between fodder stocks and troughs.

▶ Machines with surprising long-fibre distribution capabilities. The efficient and flexible operation of the POLYDRIVE system make it easier to feed hay, haylage, etc.

▶ Machines that are still the benchmark in straw blowing quality. An even quantity of straw per unit of bedding area is discharged thanks to the "shower" concept. The risk of litter overheating is limited. Animal comfort and well-being are optimal.

▶ Machines of simple design but at the cutting edge of innovation with the UNROLL SYSTEM (on PRIMOR 5570 M). With this patented system, it is possible to blow and feed straw with two round bales inside the machine body without the risk of jamming and uneven distribution.

Opt for a PRIMOR straw blower and all-fodder feeder for a combination of versatility, efficiency, strength and enjoyable, user-friendly operation.

PRIMOR 2060 M

- ▶ Hitch: mounted
- ▶ Capacity: 2 m³ (71 cu.ft)
- ▶ Load: 1 x 1.80 m (5' 11") dia. round bale
1 x 2.70 m (8' 10") cubic bale



PRIMOR

- ▶ Hitch: t
- ▶ Capacit
- ▶ Load: 1
- 2 x 1.50



Cost
Cutting



Agromony -
Zootechnics

Kuhn offers a host of bedding and feeding solutions that meet your requirements in terms of:



www.kuhn.com

DR 3570 M

trailed
 Capacity: 3.5 m³ (124 cu.ft)
 Load: 2 x 2.00 m (6' 7") dia. round bale -
 1 x 2.70 m (8' 10") dia. round bales - 1 x 2.70 m (8' 10") cubic bale



PRIMOR 5570 M

▶ Hitch: trailed
 ▶ Capacity: 5.5 m³ (194 cu.ft)
 ▶ Load: 2 x 1.80 m (5' 11") dia. round bales -
 3 x 1.50 m (4' 11") dia. round bales - 1 x 2.70 m (8' 10") cubic bale



LOW POWER TRACTORS

HIGH CAPACITY



Comfort -
Quality of life



Proximity -
Advice



Peace of mind -
Services



Distribution of all types of fodder

Today's farmers want to make use of their farm-grown products. As a result, an increasingly wide variety of products are incorporated into the rations.

Equipment used to feed rations must therefore be more and more versatile so that long-fibre fodder, such as hay and haylage, can be distributed as easily as short-fibre silage.

This is why all Kuhn PRIMOR straw blowers & feeders have two important features vital for the distribution of the longest fodder:

- a large diameter all-fodder feed rotor combined with the efficiency of a bank of regulating tines,
- the POLYDRIVE hydraulically disengageable feed rotor drive mechanism.

POLYDRIVE

THE ORIGINAL



POLYDRIVE is a hydraulically disengageable belt system that drives the feed rotor. It offers several advantages:

- Combination of the power of a mechanical drive system (power generated by turbine inertia) and the flexibility of hydraulics for easier feeding of the longest products: haylage, hay, etc.
- Flexible use. As the feed rotor is independent of the turbine when disengaged, it requires little starting power.
- The hydraulic feed rotor disengagement system interrupts straw blowing or feeding instantly.
- Safe use. As the conveyor only moves when the feed rotor is engaged, accidental operations are avoided. The conveyor stops immediately as soon as the feed rotor is disengaged.
- Silent operation offered by the belt drive.



All-fodder feed rotor

The all-fodder feed rotor on PRIMOR straw blowers and feeders is equipped with sections mounted on eight discs to preserve the structure of products such as silage (no "milling" effect) .

The shape and position of the regulating tines help spread the fodder over the entire length of the feed rotor, resulting in regular feeding of the turbine.

The high speed (400 rpm) of the large-diameter feed rotor reduces the risks of winding generally encountered with long products.

Continuously variable control

The PRIMOR 3570 M and PRIMOR 5570 M are equipped with a new adjustable control system . This bank of tines can be mounted as standard in three different positions, or alternatively comes with optional hydraulic adjustment, to make this a truly versatile machine:

► **For feeding tough products** (long hay and haylage), the bank of tines in the low position checks fodder entry into the turbine. The strands are calibrated for regular feeding.

► **For bedding, straw quality is what counts!** This is why the bank of tines in the high position helps increase the flow of straw into the turbine. Flattening is minimal.

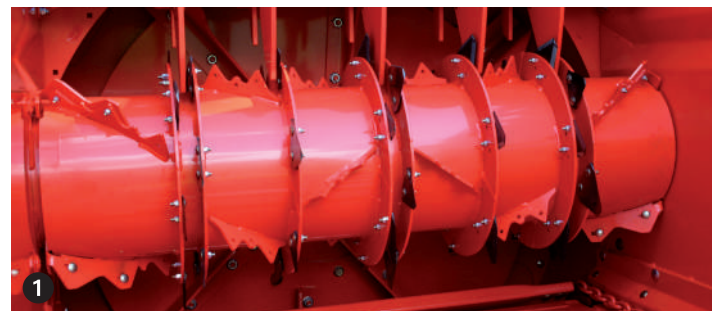

Straw bedding synonymous with animal welfare



" Bedding quality is an important link in the health chain established on your farm. That's why the solutions we provide through our machines guarantee:

- *an even amount of straw spread across the entire bedding area to limit the risk of litter overheating,*
- *preservation of the straw structure thus maintaining full absorbability and extending litter life,*
- *reduced straw consumption for greater control over the "health and hygiene" budget."*

Loïc Toulotte - Product Manager



Turbine wheel

The turbine wheel consists of eight blades, two of which are longer than the others in order to generate a speed differential in the turbine and produce a "shower" of straw.

The large working area of the broad blades (150 mm / 6") propels the product stream over the entire height of the chute. Straw is therefore blown constantly and evenly from bottom to top without needing to touch the chute.

The large working area of the broad blades (150 mm / 6") propels the product stream over the entire height of the chute. Straw is blown evenly and constantly over the full depth of the shed without upward movement of the chute cap.

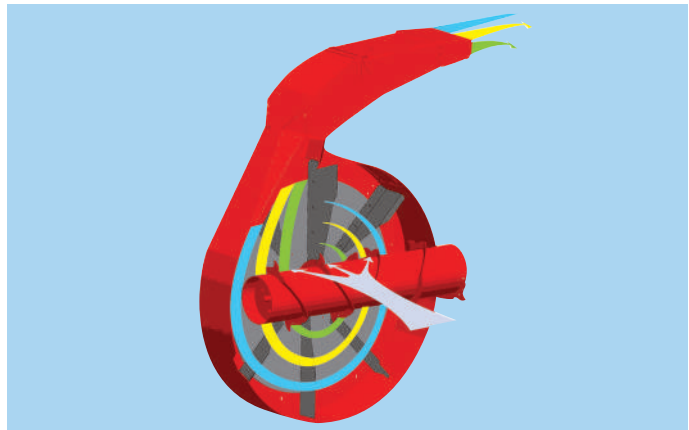

KUHN - the benchmark in straw blowing!

The 150 mm (6") deep space between the blades and the turbine inlet is referred to as the "pneumatic separating chamber".

The volume of air in motion in this chamber sucks up the product while gently separating it. The straw remains whole. The bedding keeps together better and lasts longer... and your livestock will appreciate the extra comfort!

To increase your machine's service life, the PRIMOR 3570 M and 5570 M turbine has a stainless steel bottom.

300° CHUTE: A VITAL FEATURE!



The new-generation PRIMOR is fitted with a multipurpose chute. Positioned in line with the turbine, it is designed for feeding and straw blowing up to 18 m (60') on the right-hand side. In terms of space requirement, this chute design enables the PRIMOR to deliver fodder while remaining within the tractor outline.

For difficult-to-access bedding areas, the swivel chute can be used to blow straw to the left or right of the machine (distance of 13 m - 43' - on the left).

Mounted on a circular rack, the hydraulically-powered chute is rotated by fingertip control from the tractor cab.

To meet all your farm's developments, the multipurpose chute is pre-equipped to take the "300° swivel kit".



PRIMOR 2060 M

The mounted All-Fodder feeder!



The PRIMOR 2060 M comes standard with the POLYDRIVE system. This ensures that the machine can handle straw blowing and the feeding of all long-fibre fodder such as hay or haylage.

The PRIMOR 2060 M's mounted design ensures easy handling: access to tight buildings, feeding passages with no separate exit, narrow straw blowing passages, etc.

With electric controls fitted as standard, this machine will surely satisfy all farmers looking for a user-friendly machine.



EASY HANDLING...

Overall length = 2.89 m (9' 6")



2 m³

www.kuhn.com



6

PRIMOR 2060 M: suited to all bale formats

The gently sloping tailgate is positioned in line with the conveyor for easier loading of round and cubic bales without an external loader.

The PRIMOR 2060 M body is designed to take all sizes of round bale (up to 1.80 m - 5' 11" - in diameter) and square bale up to 2.70 m (8' 10") in length.



PERFORMANCE...

Haylage feed time = 2.3 min*



* Average time recorded over 10 tests to distribute a 1.50 m (4' 11") bale of haylage

PRIMOR 3570 M

For low-power tractors!



The PRIMOR 3570 M has been developed for farmers looking for a 3.5 m³ (124 cu.ft) straw blower & feeder designed for minimum 50 hp tractor (70 hp if feeding haylage).

The PRIMOR 3570 M's capacity saves handling time: one bale up to 2.00 m (6' 7") in diameter or two bales with a diameter of 1.50 m (4' 11") to 2.70 m (8' 10") in length can easily be accommodated in the machine.

With the adjustable control system fitted as standard, the machine adapts to the fodder to be distributed by altering the angle of attack of the f



Adjustable control

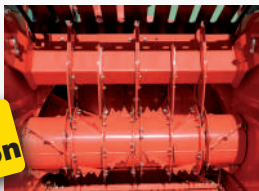

Low position

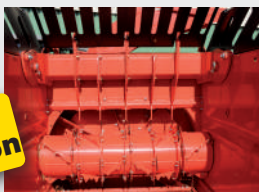

High position



Like the PRIMOR 5570 M, the 3570 M is equipped with an adjustable control system. With a hydraulic version optionally available, it is now possible to adapt the position of the regulating tines simply by activating the electric control:

- ▶ **Low position: Feeding of long products.**
- ▶ **High position: Straw blowing and silage feeding.**

To optimise your investment and adapt it to the changes in your herd's feeding plan, the manually adjustable bank of tines supplied as standard is pre-equipped for the "hydraulic control" kit. This machine can become your biggest ally by adapting to the poorest fodder crop harvests!!!

SMA



Regulating tine p

3.5 m³

www.kuhn.com



ors
. Cubic bales up
eed rotor.



Electric controls as standard

You will appreciate the user-friendliness of the electric control system. This compact system has been designed to fit in all tractor cabs.

These controls give you access to all your machine's functions without leaving your tractor seat.

Only the turbine speed (270/540 rpm) is switched by a remote control cable.

Grouped together on a single joystick, the chute swivel and cap actions can be controlled with just one hand!

8

ART!



osition indicator!



A long-life machine!

PRIMOR straw blowers & feeders are designed with easy maintenance in mind.

The conveyor is a complete subassembly bolted to the machine body which can easily be interchanged after several years' service.

To keep the conveyor clean, it is equipped as standard with a built-in dump flap : no build-up of matter in the bottom of the conveyor!



PRIMOR 5570 M

The giant-sized Straw Blower & Feeder!

> The PRIMOR 5570 M will satisfy any farmer looking for a large capacity machine. The Kuhn UNROLL SYSTEM means that three 1.50 m (4' 11") diameter bales can be blown or distributed by the machine.

The dual tailgate control is standard on the PRIMOR 5570 M and can be used to load round bales without having to return to the tractor cab during the operation.



Silage feeding

The toboggan has been designed for farmers who wish to use their PRIMOR 3570 M or 5570 M to feed silage.

Positioned in line with the turbine, it channels the product output from the chute to deliver a neat swath.

It has a broad opening to prevent any risk of blockage on feeding long products.

It is installed hydraulically on the 5570 M and by hand on the 3570 M.

The length of the toboggan is adjustable to the tractor track.



Mixing concentric

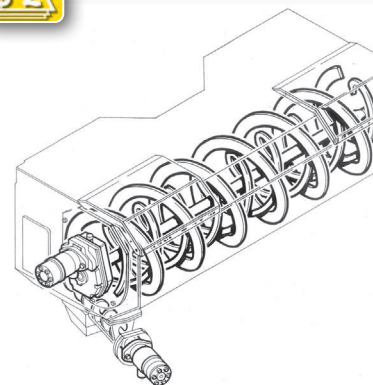

5.5 m³

www.kuhn.com



UNROLL SYSTEM



EXCLUSIVE TO

With this exclusive device, three 1.50 m (4' 11") round bales can be loaded into the machine. This system represents ultimate operating comfort by avoiding the risk of jamming and saving the time lost in getting up and down from the tractor.

- The UNROLL SYSTEM consists of two clamps positioned laterally on the body sides. They are hydraulically operated by a joystick on the main machine control and the optional dual control.
- The UNROLL SYSTEM remains open throughout the bale loading phase. During distribution of the first bale, the device closes to keep the second bale a few centimetres not only from the moving conveyor, but also from the first bale which is being separated.

In addition to the time saved and the extra efficiency, the UNROLL SYSTEM offers a number of other advantages:

- The risk of jamming caused by the pressure exerted on the first bale by the second during distribution is reduced.
- Stress on the conveyor caused by the opposite directions of rotation of the bales inside the machine body is reduced.

Minerals and concentrates into the fodder: The Mixing Hopper

With its extra-low profile and two loading doors, the hopper can be loaded effortlessly and in total safety.

Minerals and concentrates are mixed in the hopper by means of an agitator consisting of a double reverse-pitch coil. The ingredients are premixed before they are injected into the coarse fodder.

The presence of an injection auger prevents blockage problems. As the auger is driven by a hydraulic motor, you remain in control over the rate at which the concentrates are incorporated.

Concentrates are injected at the bottom of the turbine for a perfect blend as they are mixed in over three-quarters of a turn.

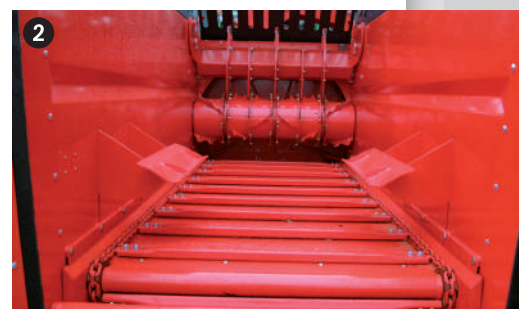
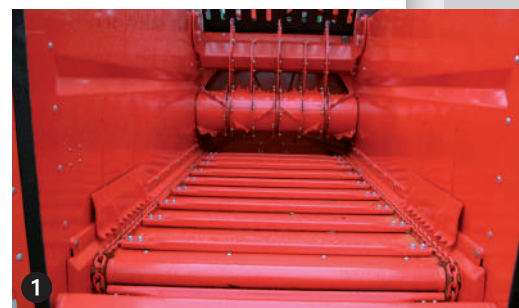

SPECIFICATIONS		PRIMOR 2060 M	PRIMOR 3570 M	PRIMOR 5570 M	PRIMOR 5570 M with Mixing Hopper
Body capacity		2 m ³ (71 cu.ft)	3.5 m ³ (124 cu.ft)	5.5 m ³ (194 cu.ft)	5.5 m ³ (194 cu.ft)
Capacity in number of bale(s)	Max. diameter of round bales	1 x 1.80 m (5' 11")	1 x 2.00 m (6' 7") 2 x 1.50 m (4' 11")	2 x 2.00 m (6' 7") 3 x 1.50 m (4' 11")	2 x 2.00 m (6' 7") 3 x 1.50 m (4' 11")
	Max. size of cubic bales	1.20 x 1.20 x 2.70 m 3' 11" x 3' 11" x 8' 10"	1.20 x 1.20 x 2.70 m 3' 11" x 3' 11" x 8' 10"	1.20 x 1.20 x 3.00 m 3' 11" x 3' 11" x 9' 10"	1.20 x 1.20 x 3.00 m 3' 11" x 3' 11" x 9' 10"
Unladen weight		1 400 kg (3085 lbs)	2 380 kg (5245 lbs)	2 900 kg (6395 lbs)	3 010 kg (6635 lbs)
Inside body dimensions	Width	1.40 m (4' 7")	1.40 m (4' 7")	1.40 m (4' 7")	1.40 m (4' 7")
	Length (1)	1.35 m (4' 5")	2.00 m (6' 7")	3.50 m (11' 6")	3.50 m (11' 6")
	Height	1.15 m (3' 9")	1.17 m (3' 10")	1.17 m (3' 10")	1.17 m (3' 10")
Overall dimensions	Width with chute retracted	1.88 m (6' 2")	2.05 m (6' 9")	2.13 m (7')	2.13 m (7')
	Width with chute extended	1.98 m (6' 6")			
	Outside width at wheels	-	2.05 m (6' 9")	2.10 m (6' 11")	2.10 m (6' 11")
	Length (1)	2.89 m (9' 6")	3.94 m (12' 11")	5.44 m (17' 10")	6.03 m (19' 9")
	Height (2)	2.27 m (7' 5")	2.60 m (8' 6")	2.60 m (8' 6")	2.60 m (8' 6")
Feeding height (3)	Height under chute at an angle of X°	1.80 m (5' 11") / 30°	2.10 m (6' 11") / 35°	2.10 m (6' 11") / 35°	2.10 m (6' 11") / 35°
	Height under the feeding toboggan at an angle of 45°		900 mm (2' 11")	900 mm (2' 11")	900 mm (2' 11")
Straw blowing height (3)	Height under chute in horizontal position	2.30 m (7' 7")	2.60 m (8' 6")	2.60 m (8' 6")	2.60 m (8' 6")
Straw blowing distance with chute to the right		18 m (60')	18 m (60')	18 m (60')	18 m (60')
Number of feed rotors		1	1	1	1
Number of regulating tines		5	5	5	5
Type of stand (4)		-	Telescopic stand	Telescopic stand	Telescopic stand
Tyres		-	10/75 x 15.3 - 12 PR	285/70 R19.5	285/70 R19.5
Turbine speed		270 / 540 min ⁻¹	270 / 540 min ⁻¹	270 / 540 min ⁻¹	270 / 540 min ⁻¹
Type of control		Electric	Electric	Electric	Electric
Recommended tractor power		66 kW (90 DIN-hp)	37 kW (51)	37 kW (51)	37 kW (51)
Recommended tractor power for long strands		66 kW (90 DIN-hp)	51 kW (70)	51 kW (70)	51 kW (70)
Tractor output and pressure requirement		30 L/min at 180 bar	30 L/min at 180 bar	40 to 60 L/min at 180 bar	60 L/min at 180 bar

(1) With tailgate closed (2) Depending on tractor and tyres (3) Machine laid on the ground or horizontal for trailed models (4) Equipment varies from country to country

OTHER EQUIPMENT				
Free-wheel transmission + slip friction clutch	■	■	■	■
Constant velocity free-wheel transmission + slip friction clutch	-	Optional	Optional	Optional
Unroll System	-	-	Optional	Optional
Dual tailgate control	Optional	Optional	■	■
300° swivel chute	Optional	Optional	Optional	Optional
Straw blowing distance to the right	18 m (60')	18 m (60')	18 m (60')	18 m (60')
	Straw blowing distance to the left	13 m (43')	13 m (43')	13 m (43')
Auxiliary hydraulic power unit	-	Optional	Optional	Optional
Pump flow rate at PTO speed of 540 min ⁻¹	-	45 L.min ⁻¹ (12 gpm)	45 L.min ⁻¹ (12 gpm)	45 L.min ⁻¹ (12 gpm)
	Reservoir capacity	-	45 L	45 L
Weighing system	-	-	Optional	Optional
Manual silage feeding toboggan	-	Optional	-	-
Hydraulic silage feeding toboggan	-	-	Optional	■
Bank of regulating tines with hydraulic control	-	Optional	Optional	Optional
Body side projection guards	-	Optional	Optional	Optional

Optional equipment varies from country to country ■ Standard equipment - Unavailable



Dual tailgate control



45 L/min⁻¹ (12 gpm) hydraulic power unit



Hydraulic toboggan



Side projection guards

"In European Union countries, our machines comply with the "Machinery" directive; in other countries, they comply with local safety legislation. In our brochures, protective devices may have been removed for the purposes of illustrating certain details. In all cases, these devices must remain in place in accordance with the instruction manual. We reserve the right to make alterations to our models or their equipment and accessories without notice. Machines and equipment in this leaflet can be covered by at least one patent and/or registered design. Registered trademark(s)."

DEALER

KUHN NORTH AMERICA, INC.
Corporate headquarters - 1501 West Seventh Avenue
P.O. Box 167 - BROADHEAD, WI 53520-0167 - USA
Phone: +1 608 897 2131 - Fax: +1 608 897 2561
www.kuhnnorthamerica.com

KUHN FARM MACHINERY PTY LTD
313 - 325 Foleys Road, Deer Park,
VIC, 3023 - Australia
Phone: +61 3 9982 1490
Fax: +61 3 8348 5999
www.kuhn.com.au

KUHN FARM MACHINERY (U.K.) LTD
Stafford Park 7
TELFORD - SHROPSHIRE TF 3 3 BQ
Phone: (01952) 239300/1/2 - Fax: (01952) 290091
www.kuhn.co.uk

