

Tempo

Unmatched precision at very high speed

VÄDERSTAD





Where farming starts

Together with farmers all over the world, we have spent the last three generations creating machines that make any farmland find its full potential. The high quality Väderstad planters, seed drills and tillage equipment give farmers a head start by covering more ground in shorter time without losing perfection.

Together we make you an even more successful farmer.



Maximise the potential of your crops

Every component on the Tempo planter is built to ensure the exact same start for all seeds. No matter the speed – no matter the field condition. The even seed placement results in a crop that matures at an even rate and is more likely to yield to full potential.





Unmatched precision

The Tempo planter delivers an exact seed spacing, even seed depth and no overlap planting on headlands.

On top of this, the planting precision is always the same irrespective of outside influences such as speed, vibrations, slopes or varying field conditions.

Working with positive air

The Tempo seed meter uses positive air pressure to make each single seed find its place on the rotating seed discs one by one. To ensure top performance, three speed independent singulators at the top of the seed meter remove any excess seeds.

Leaves nothing to chance

When the seed reaches the seed tube, the air pressure is cut off to accurately put the seed into the seed tube. Now the air pressure once again takes control and shoots the seed down to the soil. Since all seeds are granted the exact same transport time from the seed meter down to the seed furrow, precision is secured. At Väderstad, we call this PowerShoot technology.

Leaving the short seed tube, each seed is gently received by a stop wheel. This ensures optimal seed-to-soil contact at selected planting depth.



Highest precision in all dimensions

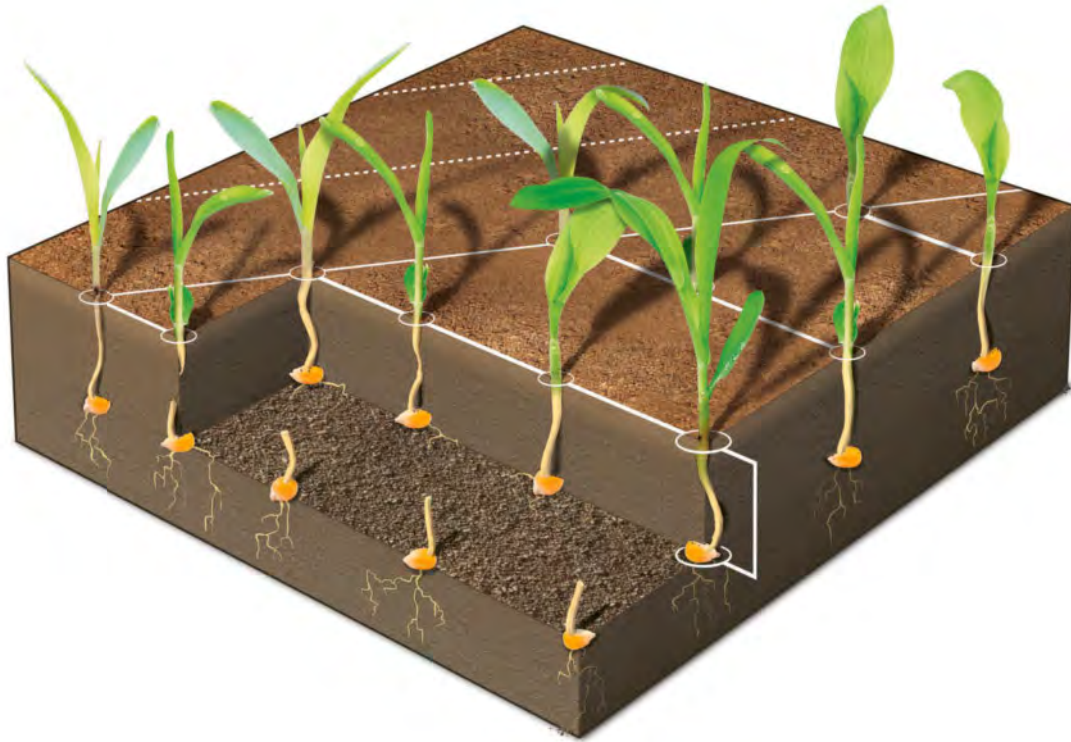

In-row precision

The Tempo seed meter, together with PowerShoot guarantees that each seed is placed one by one with extreme accuracy in the seed furrow.

By providing even plant spacings, without skips and doubles, Tempo delivers very high in-row precision. This means that all plants are granted the same growing conditions from the start.



Depth precision

The Tempo planter has a heavy-duty design, transferring high weight to the row units. Together with its components, this ensures a stable ride with maintained planting depth in all conditions.

The exact depth precision leads to an even germination, which in turn is crucial to grow strong and healthy crops with great yield potential.



End-of-row precision

Each row unit on the Tempo planter is electrically driven, enabling GPS-controlled individual row shut-off.

By eliminating overlaps on headlands and irregular field areas, potential yield losses are avoided at the same time as the input costs can be reduced by 5-10%. Tempo enables section control for seed, fertiliser and micro granulates.

Speed is not an issue

The Tempo seed meter stands out from the crowd. Thanks to the PowerShoot technology, which uses air pressure to maintain full control of the seed all the way down to the soil; gravity, vibrations and slopes are removed from the equation. Speed is not an issue for Tempo.





The value of high-speed planting

High-speed planting provides several benefits. Since a larger area can be covered with the same working width, while also improving precision, there are several ways to increase net profit.

1

When timing is everything

The ideal planting window is typically narrow. Some years extreme weather limits the time available even further. Planting within the optimum period provides perfect temperature and moisture for the planted crop. Any delay reduces the yield potential.



2

Increased field efficiency

By planting with high speed the capacity of the planter increases. Allowing a smaller planter is able to cover the same area as a larger model. You benefit from an increased field efficiency, as well as lower horsepower requirements on the tractor.



3

One planter instead of two

High-speed planting means that more hectares can be covered with fewer row units. This drastically lowers input costs for the machine itself, but it can also save a tractor and driver in some cases.

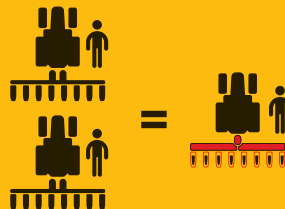

PowerShoot



The key for high-speed planting

The patented PowerShoot technology makes the Tempo planter stand out from the crowd.

On traditional planters, the seed falls freely through the seed tube from the seed meter down to the soil. When vibrations arise as the speed increases, the seed bounces in the seed tube and much of the precision of the seed meter is lost. This is one of the reasons why many planters are limited to low planting speeds.

PowerShoot uses positive air pressure to shoot the seeds at 50km/h down the short seed tube. This gives the Tempo planter full control of the precision of each seed, from the seed hopper all the way down to the seed furrow.

Full control. Always

Tempo takes modern technology to the field. Each Tempo row unit is individually electric driven and the control system Väderstad E-Control seamlessly establishes a realtime communication between the planter, the tractor and you as a driver. The planter electronics constantly ensures performance and you benefit from user-friendly remote setup, as well as real-time monitoring and full control.





One by one. Creating success together

Each row unit has its own robust electric motor giving you full control of the output and performance of the planter. Calibration and adjustments can be done for the entire machine or for individual rows.

Compared with mechanically driven planters, the electrical drive additionally avoids problems with slipping drive wheels or problems with chains which result in an uneven metering.

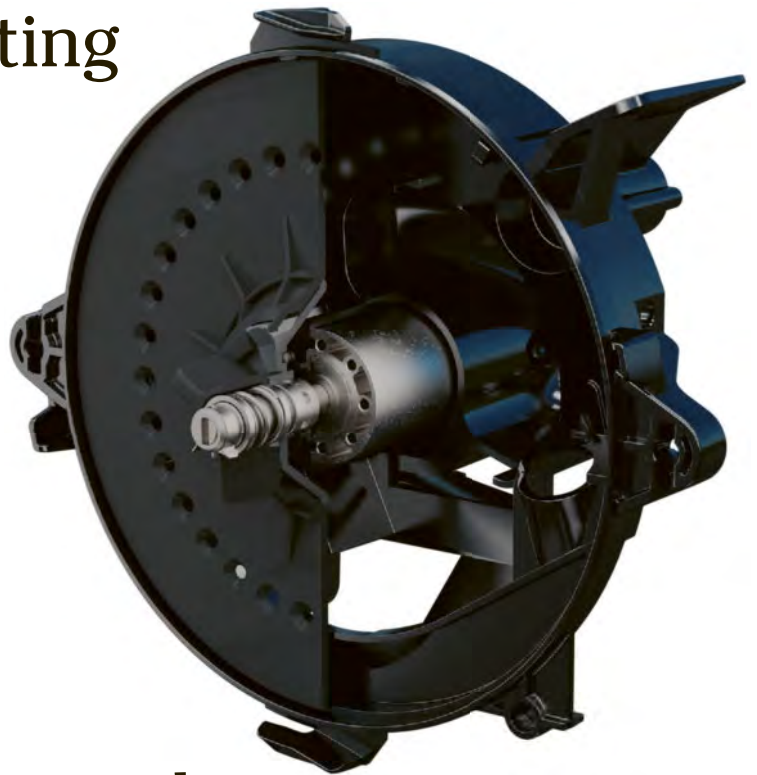

E-Control – Full control at your fingertips

The modern iPad-based control system E-Control wirelessly connects to the Tempo planter enabling full access to its functions and data in real-time.

With a touch of a button you are able to adjust the fertiliser or seed rate, turn on and off individual row units or monitor the planting precision. Additionally, the user-friendly E-Control makes calibration and machine settings quick and simple.



Take precision to a new level

Having individually controlled row units and a control system completely designed to deliver the most out of the machine, opens up several ways to evolve precision and planting performance even further.

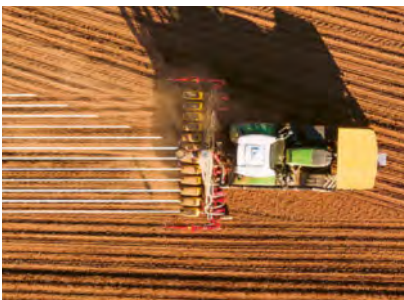

Row by row shut-off

To avoid overlap planting, saving seeds and inputs in irregular fields, each row unit can be shut-off one at a time. This can either be controlled manually or using GPS and ISOBUS Task Controller.

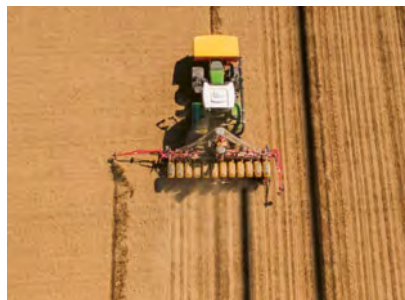

Easy-to-use tramlining

Tempo makes tramlining simpler and more reliable than ever before. The function is easy to setup with E-Control. When planting the field, Tempo automatically shuts off specific row units when needed to match the tyre tracks of the sprayer.



Individual calibration

Tempo is the obvious choice for seed growers. Since the row units are electric driven one by one, the same machine is able to plant multiple seed types with differing seed rates and varying row spacings. It is setup and monitored using E-Control.

Full versatility

An important feature of the Tempo planter is its ability to adapt to different requirements on the farm. By easily changing the row spacing, adjusting the number of row units or switching from one crop or field to the next, you are able to increase the usage and capacity of your planter even further.

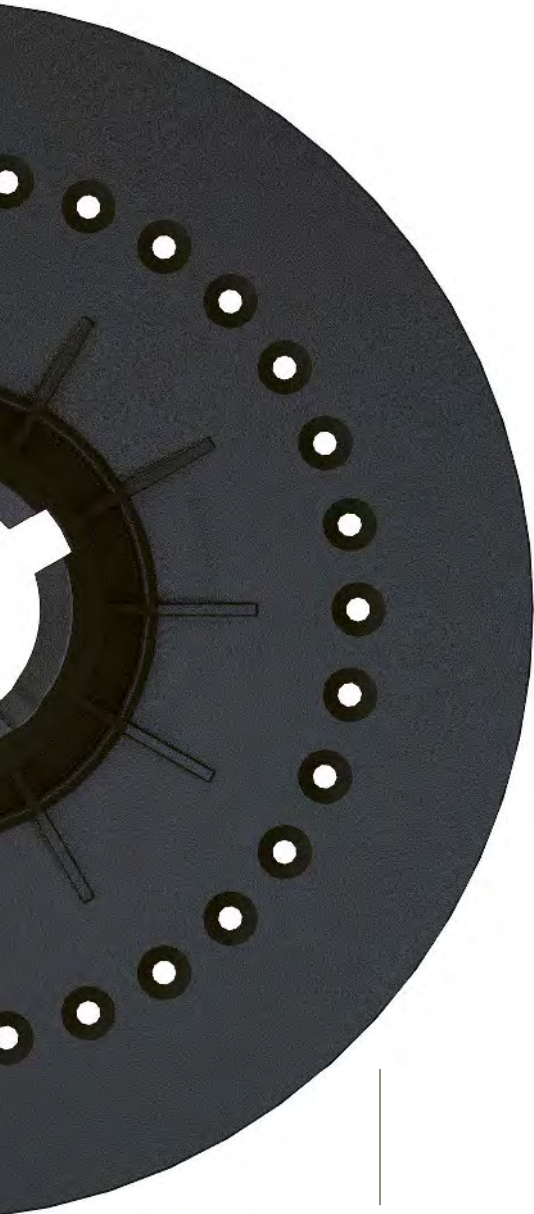

Maize



Sunflower



Soya bean



Sorghum



Sugar beet



Cotton



Oilseed rape



Pumpkin

One machine – multiple crops

Maize, sugar beet, soya beans, sunflower, oilseed rape, cotton, sorghum and many more – Tempo is able to plant a full range of crops with excellent results.

By easily changing the row spacing and machine setup for different crops, Tempo offers high versatility on the farm. The result is increased efficiency and minimised machine costs per hectare. In some cases one Tempo can replace two machines on the farm.

Designed for quick operation

The main setup for switching between crops is to change the high performance seed discs in the row units. Changing the seed discs is easily carried out in a matter of seconds without the need of tools.

When emptying the hoppers and metering units from the previous seed, a smart emptying hatch ensures best results.

The Tempo high performance seed discs is made from composite plastic. This durable and cost-effective solution results in a maximised precision while the PowerShoot system doubles the seed disc working life by reducing friction.

Maximise precision in all conditions

Tempo is capable of planting with up to 325kg coulters pressure. This enables high-speed planting in a wide range of field conditions and tillage systems.

Thanks to the heavy-duty row unit and effective row cleaners, Tempo is able to deliver perfect results in all conditions.

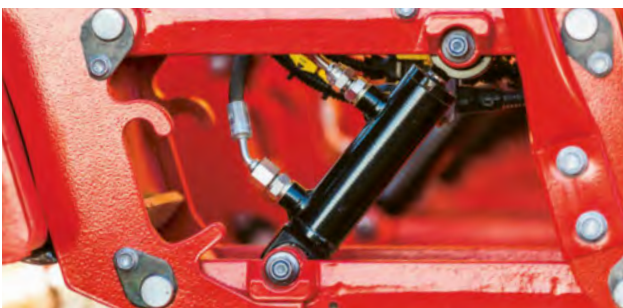

Exact working depth in all conditions

To maintain accurate row unit pressure in all conditions, the Tempo models can be equipped with hydraulic weight transfer. By enabling both positive and negative pressure, it is possible to ensure the best start possible for a wide range of seed types in differing field conditions. The hydraulic weight transfer is easily controlled via the control system E-Control on the go from the tractor cab.

High speed floating row cleaners

To ensure exact row cleaning results adapted to individual field conditions, all Tempo models can be fitted with floating row cleaners. The parallel mounted row cleaner is fitted with a self-cleaning rubber wheel, enabling it to precisely follow the field surface. With optimised working angles, the floating row cleaners are designed to perfectly match the speed and precision of the Tempo planter.

High-speed fertiliser placement

To place fertiliser with precision together with planting provides a supply of nutrients where the seed needs it the most. This increases yield and fertiliser efficiency, while also reducing passes on the field.

Heavy-duty fertiliser coulters

Tempo can be equipped with a fertiliser hopper and highspeed disc fertiliser coulters. The fertiliser can be placed according to need, both sideways and depth wise.

The fertiliser coulters are spring-loaded and can apply a force up to 150kg. This increases the fertiliser efficiency and raises the yield potential, while also reducing passes on the field.

Section control saves fertiliser

The Tempo fertiliser metering enables sectional shut-off on most models with some models even on individual rows. This maintains the correct application on irregular fields and provides equal conditions for the plants.

Optimised yield with variable rate

Electric motors enable variable fertiliser rate, offering higher yield with the same amount of fertiliser.

Both the fertiliser coulters as well as the row units can be adjusted to desired row spacing on the frame.

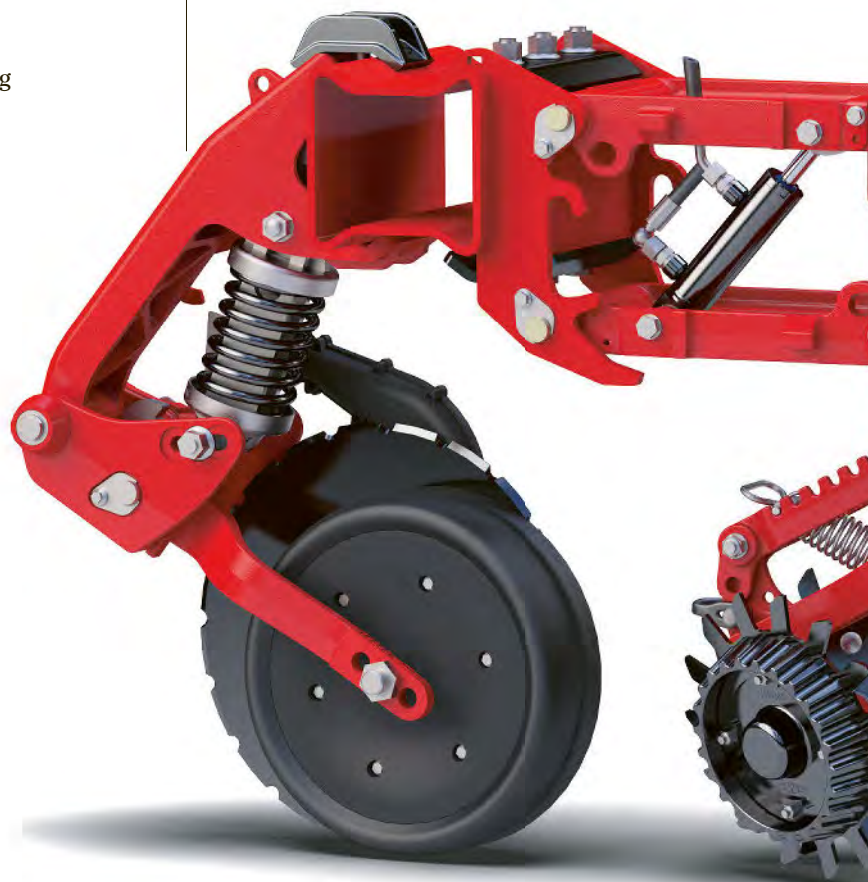

Precise micro granulate application

The micro granulate kit allows for a pesticide, slug pellet or starter fertiliser to be placed with precision while planting. The micro granulate can be placed either on top of the seed in the seed furrow or on the field surface.

Individual electric drive on each micro granulate meter enables row-by-row shut-off of the micro granulate, together with the seed and fertiliser. This saves input cost and maximises results.



The rollers are easily changed without any need for tools.





Tempo R 4-6

Tempo R 4-6 is a mounted high-speed planter available with 4 or 6 row units, and fertiliser metering as option. The rigid frame benefits from minimal weight and reduced maintenance without compromising on excellent precision.



With easily adjustable row spacing, it is possible to plant numerous crops with the same machine, enabling greater usage.

Designed for multiple crops

Tempo R has a frame designed to enable simple setup of row spacing and number of row units. With six rows, the machine can be configured to 450 or 500mm row spacing, while the four-row version can be adjusted to 700, 750, 762 or 800mm.

Easy to manoeuvre

Tempo R is mounted on the tractor's three-point linkage, making it easy to manoeuvre in the field. Without the need of a front hopper, the attached fertiliser hopper takes up little space when stored. You benefit from small turning radius on headlands and convenient transport between fields.

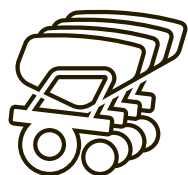

4-6



450-800mm

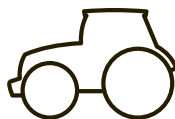

>70hp



70 litre

High precision – robust design



Tempo R can be equipped with a 1200 litre fertiliser hopper and disc fertiliser coulters.



The 3 metre wide Tempo R is mounted on the tractor's three-point linkage, making it easy to manoeuvre in the field.

Tempo T 6-7

Tempo T is a mounted high-speed planter available with 6 or 7 row units, and fertiliser metering as an option. The telescopic frame allows for unprecedented precision, while at the same time making the machine very easy to handle and transport.



One machine – multiple crops

The frame of Tempo T is equipped with a heavy-duty telescopic wing retraction, making it possible to adjust the frame width to fit different crops. When changing the frame width, the row spacing and number of row units can be easily adjusted. As an example, Tempo T is able to plant maize using 6 rows at 750mm, sunflower or soybeans using 7 rows at 600mm and oilseed rape using 6 rows at 500mm.

The obvious choice for seed growers

The individually electric driven Tempo row units offer great possibilities for high precision seed planting.

The same machine is able to plant multiple seed types with differing seed rates and varying row spacings. The telescopic frame makes adjusting the machine to your demands very easy.

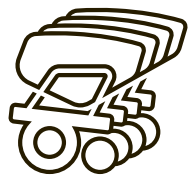

6-7

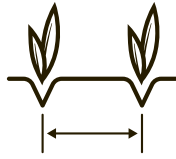

500-800mm

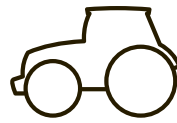

>100hp



70 litre

Telescopic precision



Tempo T has a transport width between 3.3 and 3.5 metres. This gives a small turning radius and convenient transport.



Tempo T can be equipped with a 1200 litre fertiliser hopper and disc fertiliser coulters.

Tempo F 6-8

Tempo F is a trailed high-speed planter, available with 6 or 8 row units and fertiliser application as an option. The placement and design of the support wheels maintain the seed depth in all conditions which ensures an even crop.



Tempo F offer very high fertiliser capacity with individual row shut-off, resulting in maximised uptime and fertiliser savings.

Impressive depth control

To ensure optimal depth control, Tempo F is equipped with hydraulic support wheels mounted between the row units, avoiding any tilting in hilly conditions. The wide tyre profile maintains the working depth irrespective of soil type. The large diameter ensures a smooth ride at high speeds, improving planting precision.

High precision planting for every farm

Tempo is designed to fit most tractors. It has a low hydraulic requirement, self-sufficient electric power and requires low draught force. Tempo F has the option to equip the planter with a PTO driven fan, reducing the dependency of the tractor whilst still maintaining high precision planting.



6-8

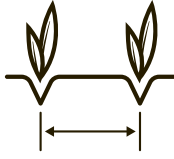

700-800mm

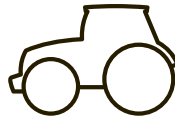

>100hp



70 litre

Performance and precision

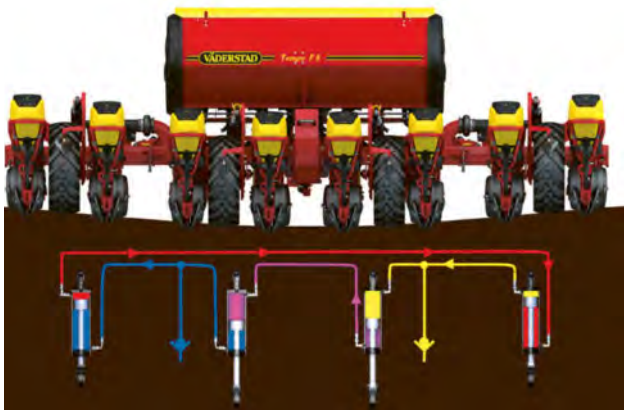

The wheels on Tempo F 8 are coupled as a hydraulic bogie unit – walking tandem. This ensures an even load on all wheels, giving a smoother ride on uneven ground.



A trailed planter puts less weight on the tractor, leading to minimal soil compaction. The benefit of this is a healthy soil structure and an even crop emergence.

Tempo V 6-12

Tempo V is available with 6 to 12 row units, including odd numbers. The ability to use the same machine for multiple crops often means that two traditional planters can be replaced. This increases usage and lower the hectare costs.



Tempo V has an open frame design making it easy to adjust the row spacing to suit numerous seed types grown on the farm. The result is increased productivity and lower costs. As an example, you could start the season by planting sugar beet at 500mm row spacing, followed by maize at 750mm row spacing and finally in the autumn plant oilseed rape at 450mm row spacing.

Quick change

Tempo V can be altered from 12 rows to 8 rows in less than one hour. A row unit trolley facilitates the work and makes storage easy.

Great mobility

All Tempo V models are vertically folded to 3 metre transport width. The machine is mounted on the tractor's three-point linkage, making it easy to manoeuvre in the field. In the field, this results in short turning radius on headlands and convenient transport.

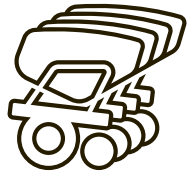

6-12

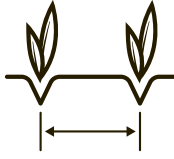

450-800mm

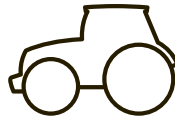

>100hp



70 litre

Maximum versatility



WideLining automatically adapts the row spacing to the wheel tracks of the liquid manure spreader, without lowering the number of seeds planted on the field.



In combination with the front hopper FH 2200, Tempo V is able to combi-drill fertiliser at high speed.

Tempo R 12-18

Tempo R 12-18 is a rigid, mounted high-speed planter with fertiliser metering as an option. With easily adjustable row spacing, it is possible to plant numerous crops with the same machine, enabling greater usage.



The three-point linkage provides excellent manoeuvrability and short headlands. Additionally, a rigid frame benefits from fewer moving parts, minimal weight and reduced maintenance without compromising the excellent precision Tempo R offers.

Multiple crops with one machine

Tempo R has a frame designed to enable simple setup of row spacing and number of row units, including odd numbers. The row spacing on the 18 row Tempo R 18 can

be set down to 450mm, while the 12 row model can be configured between 700 to 800mm. This results in more hectares per season and consequently lowers costs.

Transport wheels for wider models

Equipped with optional transport wheels and drawbar, Tempo R 12 and Tempo R 18 can be easily transported between the fields on the farm. Despite the wide working width, the transport width fits under 3 metres.



12-18

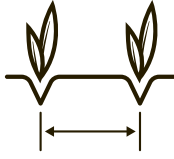

450-800mm

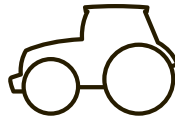

>250hp



70 litre

Robust capacity



The front mounted fertiliser hopper FH 2200 enables high precision combi-drilling.



Equipped with transport wheels and a drawbar, Tempo R 12-18 can be easily transported between fields.

Tempo L 8-24

Tempo L is a trailed high-speed planter with an enormous capacity. Tempo L doubles the capacity of a traditional planter. Most importantly, the crop is established with higher precision.



Tempo L can be equipped to place fertiliser together with planting. Depending on the model, either a 3000 or 5000 litre fertiliser hopper is available. The fertiliser is metered via the high capacity metering system, Fenix III. The metering capacity for fertiliser is up to 350kg/ha at 15km/h. The electric driven Fenix III has the capability to adapt the fertiliser rate to varying field conditions by using a variable rate system. The high capacity fertiliser system maintains the high precision even at high speed.

Perfect depth control

Tempo L is equipped with hydraulic wing pressure which transfers weight from the inner section of the machine to

its outer wings. This enables Tempo L to respond to any irregularities on the field and ensure an even emergence.

Telescopic wheel axle

To ensure the transport wheels follow the row spacing, Tempo L can be fitted with a telescopic wheel axle which is easily adjusted from the cab. So whatever the row spacing, the transport wheels can be adjusted to always run between the seed rows. The wheel axles are easily set to 3 metre width for transport.



8-24

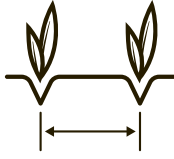

450-800mm

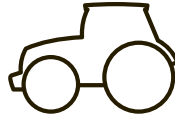

>150hp



90 litre

Enormous capacity – superior precision



A 3000 litre fertiliser hopper is available as a compliment to the 5000 litre hopper on the top-capacity models.



Despite its enormous capacity on the field, Tempo L folds to 3 metre transport width.

Tempo L 8-24 with Central Seed Fill

Tempo L 8-24 with Central Seed Fill is the top-capacity model in the high-speed Tempo planter family. With fewer and quicker stops for filling, the productivity is maximised on the field.



Tempo L with Central Seed Fill is equipped with a 3000 litre seed hopper. The Central Seed Fill system works as a pressurized system, constantly feeding the high precision Tempo seed meters at the row units. When the seeds has been delivered to the seed meters, the patented PowerShoot technology ensures excellent high-speed planting precision.

Perfect depth control

Tempo L with Central Seed Fill is equipped with hydraulic wing pressure which transfers weight from the inner section of the machine to its outer wings. This enables the machine to respond to any irregularities on the field and ensure an even emergence.

True planting capacity

Today, thousands of farmers worldwide have seen their farmland find its full potential thanks to the Tempo planter. Tempo L with Central Seed Fill is built with a clear focus – maximise planting capacity and precision even further. By delivering exceptional precision at very high speed, the Tempo planter is able to achieve more in a day's work. Most importantly, the crop is granted an unmatched yield potential.



8-24

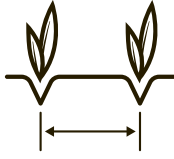

450-800mm

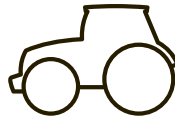

>150hp

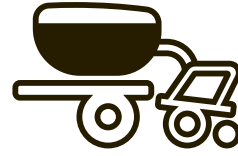

3000 litre

Capacity and precision maximised



Tempo L with Central Seed Fill benefits from the same PowerShoot metering system as all Tempo planters, ensuring exact precision at very high speed.



The 3000 litre seed hopper is designed with the operator in mind, making the filling quick and easy.

FH 2200

The front-mounted fertiliser hopper FH 2200 enables high precision combi-drilling. The 2200 litre hopper is equipped with the electric Fenix III metering system and is suitable for large capacity and high working speeds on the field.



FH 2200 delivers a measure of fertiliser distribution that takes full advantage of the capacity of the Tempo planter.

Next generation precision metering

FH 2200 is equipped with the user-friendly and easily accessible metering system, Fenix III. It is able to handle high rates, up to 250kg/ha at 15km/h. Together with its powerful hydraulic fan, FH 2200 ensures an even fertiliser distribution also at high working speeds. One important feature of Fenix III is the soft feed rotor that seals the

metering system, reducing the air requirement and in turn saves fuel.

Large and easy to fill hopper

The sloping front design of the front hopper, gives the driver good visibility. The wide opening and built in step makes it easy to fill. As an option, the FH 2200 can be equipped with extra weight packages. This places additional weight on the front wheels of the tractor, increasing its traction.

High capacity fertiliser output



The Fenix III metering system is designed for precise metering reliable performance and easy maintenance.

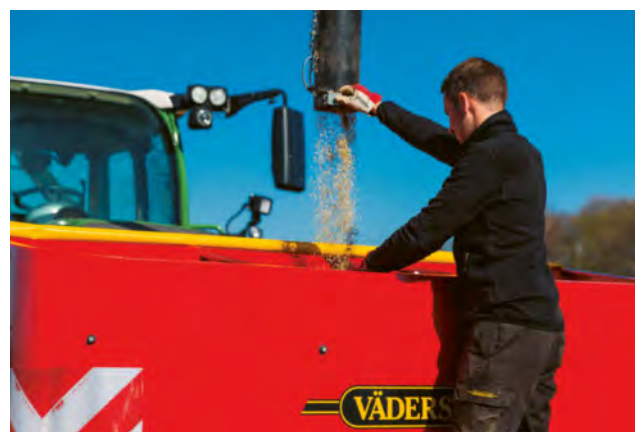

The sloping front design gives the driver good visibility. The wide opening and built in step makes it easy to fill.

Väderstad E-Control – New generation control system

The iPad-based control system Väderstad E-Control wirelessly connects to the Väderstad machine enabling full access to its functions and data. You benefit from user-friendly remote setup and calibration, as well as real-time monitoring and control.



The portable office

Väderstad E-Control is a fully portable control system ready to be used when and where it is required. When calibrating the Väderstad machine, you can take the portable iPad out of the tractor and control the calibration from outside.

When your day is over you can take the iPad to the office and start planning the next days work.



State of the art graphics

The high-resolution iPad-display presents all the information clearly. The outstanding graphics make every function easier to utilise.

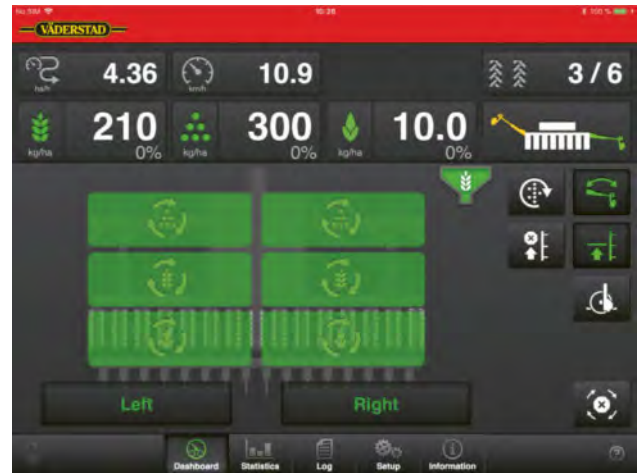

Since Väderstad E-Control is used for many planters and seed drills in the Väderstad range, the same iPad can be used for multiple machines on the farm.

Always up to date

At Väderstad, we find it very important to support and service all our customers to the fullest. Therefore, all E-Control software updates are easy to download free of charge. With E-Control, you are always sure to benefit from the latest technology and the newest innovative solutions from Väderstad.

Combined control with ISOBUS Task Controller

Using Väderstad E-Control together with an ISOBUS terminal allows for automatic GPS section control and variable seed rate. A list of terminals compatible with ISOBUS Task Controller can be found on our web page vaderstad.com by searching for ISOBUS.

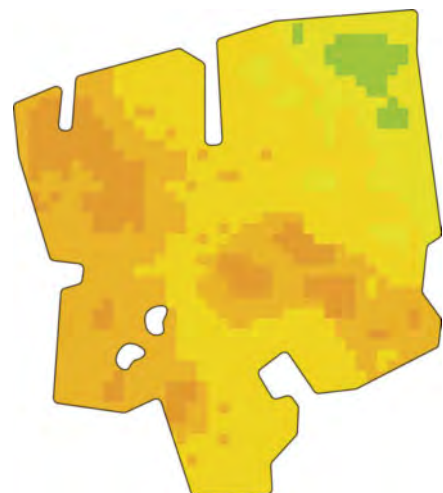

Accessories



Elevated air intake

To be used in conditions with airborne debris. Fits most Tempo models.



Fertiliser kit

Complete fertiliser kit including hopper and disc coulters, to ensure great working results in all conditions.



Micro granulate kit

Used to place either a starter fertiliser, slug pellet or pesticide with precision in or on top of the seed furrow.

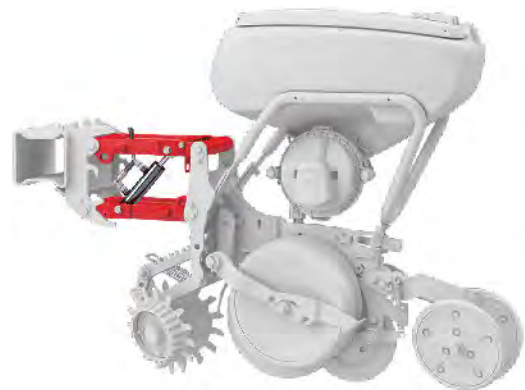

Hydraulic weight transfer

Maintains the row unit pressure and seed depth at all times. Can apply either positive or negative pressure.



Floating row cleaners

Recommended when planting in plant residues. Mounted on a parallel linkage for precise field contouring.



Row unit trolley

For easy handling when changing number of rows or adjusting the row spacing on the Tempo planter.



Seed tube with seed sensor

Seed tube with 16 or 22mm diameter. The 22mm is adapted for large seeds such as large beans.



Closing wheels

Tempo can be equipped with four different types of closing wheels - 25mm, 50mm, spiked or treaded.



Seed discs and knockout wheels

Available with different hole sizes for a wide range of crops.

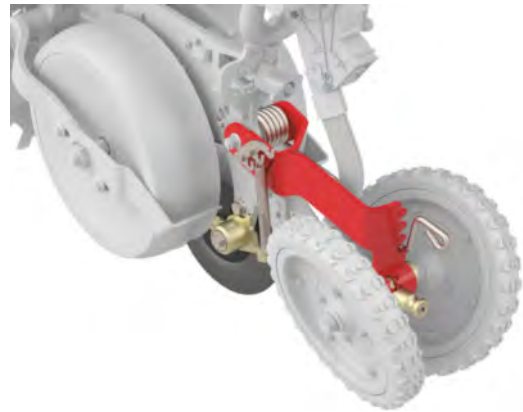

Small seeds kit

Adjustable closing wheels, spring loaded stop wheels and air grid for small seed crops, such as oilseed rape and sugar beet.



Filling auger

Tempo F can be equipped with a hydraulic driven filling auger in stainless steel with 150mm diameter.



PTO pump

To enable lower tractor hydraulic requirements, Tempo L can be equipped with a PTO pump.

	TPT 6	TPT 7
Number of rows	6	7
Row spacing (mm)	450/457/500/ 508/550/600/ 650/700/750 762/800	500/550/600
Working width (m)	2.7-4.8	3.5-4.2
Transport width (m)	3.36-3.5	3.36-3.5
Transport height (m)	3.2	3.2
Weight Seed only (kg) min-max	1400-1700	1750-2250
Weight with fertiliser hopper (kg) min-max	1900-2200	2000-2500
Volume seed hopper per row (l)	70	70
Volume micro granulate hopper per row (l)	17	17
Fertiliser hopper (l)	1200	1200
Oil flow requirement (l/min)	60	60
Draught requirements (hp)	100-200	100-200
Hydraulic requirements	2-3 DA+FR	2-3 DA+FR

	TPF 6	TPF 8
Number of rows	6	8
Row spacing (mm)	700/750/ 762/800	700/750/ 762/800
Working width (m)	4.2-4.8	5.6-6.4
Transport width (m)	3.0-3.3	3.0-3.3
Transport height (m)	3.0-3.2	3.4-3.8
Weight Seed only (kg) min-max	2000-2700	2700-3400
Weight with fertiliser hopper (kg) min-max	2700-3300	3400-4200
Volume seed hopper per row (l)	70	70
Volume micro granulate hopper per row (l)	17	17
Fertiliser hopper (l)	1275	1700
Oil flow requirement (l/min)	90	90
Draught requirements (hp)	100-200	140-250
Hydraulic requirements	1-4 DA+FR	1-4 DA+FR

	TPV 6	TPV 7	TPV 8	TPV 9
Number of rows	6	7	8	9
Row spacing (mm)	700/750/ 762/800	600	450/457/500 508/700/762 800	600/750
Working width (m)	4.2-4.8	4.2	3.6-6.4	5.4-6.8
Transport width (m)	3.0	3.0	3.0	3.0
Transport height (m)	3.0	3.0	3.0-4.0	4.0
Weight Seed only (kg) min-max	1700-2200	1800-2400	1900-2700	2100-3000
Weight with fertiliser hopper (kg) min-max	-	-	-	-
Volume seed hopper per row (l)	70	70	70	70
Volume micro granulate hopper per row (l)	17	17	17	17
Fertiliser hopper (l)	-	-	-	-
Oil flow requirement (l/min)	60	60	60	60
Draught requirements (hp)	100-150	100-150	150-200	150-200
Hydraulic requirements	2-3 DA+FR	2-3 DA+FR	2-3 DA+FR	2-3 DA+FR

	TPV 10	TPV 11	TPV 12
Number of rows	10	11	12
Row spacing (mm)	600/750/756	600	450/457/ 500/508
Working width (m)	6.0-7.6	6.6	5.4-6.1
Transport width (m)	3.0	3.0	3.0
Transport height (m)	4.0	4.0	4.0
Weight Seed only (kg) min-max	2300-3200	2400-3200	2500-3600
Weight with fertiliser hopper (kg) min-max	-	-	-
Volume seed hopper per row (l)	70	70	70
Volume micro granulate hopper per row (l)	17	17	17
Fertiliser hopper (l)	-	-	-
Oil flow requirement (l/min)	60	60	60
Draught requirements (hp)	180-250	180-250	180-250
Hydraulic requirements	2-3 DA+FR	2-3 DA+FR	2-3 DA+FR

	TPR 4	TPR 6	TPR 12	TPR 18
Number of rows	4	6	12	18
Row spacing (mm)	700/750/ 762/800	450/457/ 500/508	700/750/ 762/800	450/457/ 500/508
Working width (m)	2.8-3.2	2.7-3.0	8.4-9.6	8.2-9.1
Transport width (m)	3.0	3.0	8.1 (700) 9.1 (750/762/800)	8.1(450/457) 9.1 (500/508)
Transport height (m)	1.9-3.2	1.9-3.2	2.1-3.5	2.1-3.5
Weight Seed only (kg) min-max	1100-1400	1400-1700	2800-3300	3700-4400
Weight with fertiliser hopper (kg) min-max	1600-1900	1900-2200	-	-
Volume seed hopper per row (l)	70	70	70	70
Volume micro granulate hopper per row (l)	17	17	17	17
Fertiliser hopper (l)	1200	1200	-	-
Oil flow requirement (l/min)	60	60	60	60
Draught requirements (hp)	70-100	70-100	250-300	300-530
Hydraulic requirements	1-2 DA+FR	1-2 DA+FR	1-2 DA+FR	1-2 DA+FR
	TPL 8	TPL 10	TPL 12	TPL 16
Number of rows	12	10	12	16
Row spacing (mm)	700/750/ 762/800	750	450/457/500/ 508/700/750/ 762/800	700/750/762
Frame width (m)	6	7.2	6.0-9.7	10.8-12.0
Working width (m)	5.6-6.4	7.5	5.4-9.6	11.2-12.2
Transport width (m)	3.0	3.0-3.4	3.0	3.0
Transport height (m)	4.0	4.0	4.0	4.0
Weight (kg) min-max	5600-7500	5900-7900	6100-9200	7500-10100
Volume seed hopper per row (l)	90	90	90	90
Volume micro granulate hopper per row (l)	30	30	30	30
Fertiliser hopper (l)	3000	3000	3000/5000	5000
Oil flow requirement (l/min)	110-140	110-140	110-200	170-200
Draught requirements (hp)	150	180-230	200-250	200
Hydraulic requirements (Seed only)	-	4 DA+2 FR	-/4 DA+2 FR	4 DA+2 FR
Hydraulic requirements (Combi)	5 DA+2 FR	5 DA+2 FR	5 DA+2 FR	5 DA+2 FR
	TPL 18	TPL 24		
Number of rows	18	24		
Row spacing (mm)	450/457/ 500/508	450/457/ 500/508/559		
Frame with (m)	8.2-9.7	10.8-12.0		
Working width (m)	8.1-9.1	10.8-12.2		
Transport width (m)	3.0	3.0		
Transport height (m)	4.0	4.0		
Weight (kg) min-max	7200-10500	8400-11800		
Volume seed hopper per row (l)	90	90		
Volume micro granulate hopper per row (l)	30	-		
Fertiliser hopper (l)	3000/5000	5000		
Oil flow requirement (l/min)	170-200	170-200		
Draught requirements (hp)	250-300	300		
Hydraulic requirements (Seed only)	4 DA+2 FR	4 DA+2 FR		
Hydraulic requirements (Combi)	5 DA+2 FR	5 DA+2 FR		
	FH 2200			
Metering system	Elektric Fenix III			
Transport width (m)	2.7 (hopper 2.4)			
Transport length (m)	1.6			
Fertiliser hopper (l)	2200			
Weight empty hopper (kg)	600			
Hydraulic requirements	1 DA+1 FR			
Electronics	E-Control/ Gateway			
Front linkage	CAT 2			

DA=Double acting FR= Free return

Väderstad Holding AB is the owner of a number of intellectual property rights, such as patents, trademarks and design rights.
The product(s) featured in this document may be protected by one or more such rights.

More to see with Augmented Reality!

By using the “Väderstad AR” app on your smartphone or tablet, you are able to make content in this brochure come to life. The “Väderstad AR” app is available for free download in Apple App Store or Google Play Store. It is easy to use. Simply open the Väderstad AR app and point the camera towards one of the AR triggers in this brochure!



Where you see this AR trigger, there is hidden content available.



Where farming starts