

*MAZDA CX-5*



*zoom-zoom*  
*zoom-zoom*  
*zoom-zoom*

*IMAGINATION DRIVES US*

# IMAGINATION DRIVES US

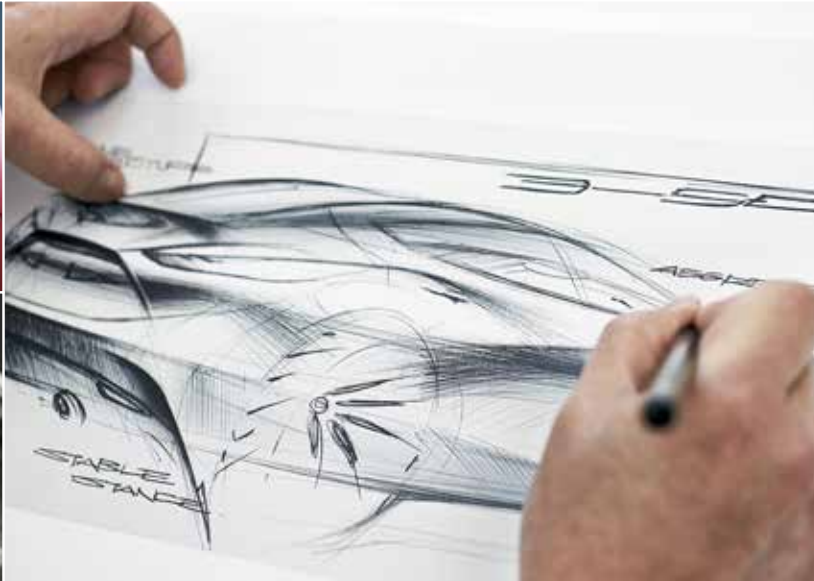

Imagination is the world's most valuable resource. It's our window to the future, because if we can imagine it, we can create it. Mazda is built on a foundation of imagination and ingenuity. It's the fuel behind all we create and achieve. It has given us SKYACTIV TECHNOLOGY, 'KODO – Soul of Motion' design and countless successes that once existed only in someone's imagination. These pages show how imagination is an integral part of our innovative cars.



**4**  
INTRODUCTION



**6**  
EXTERIOR



**8**  
INTERIOR



**10**  
DYNAMICS



**12**  
PERFORMANCE & SKYACTIV TECHNOLOGY



**14**  
CONNECTIVITY



**16-19**  
FEATURED INNOVATION

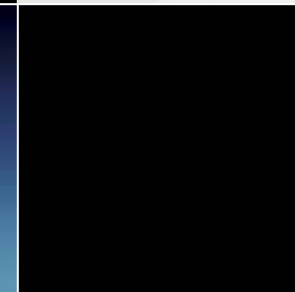

**20**  
SAFETY

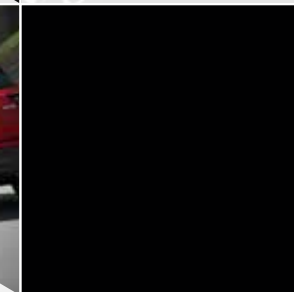

**22**  
i-ACTIVSENSE



**24-31**  
MODELS



**32-37**  
SPECIFICATIONS



**38**  
CONFIDENCE

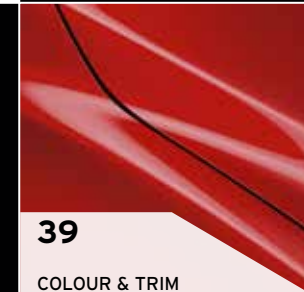

**39**  
COLOUR & TRIM



**MAZDA CX-5.  
AN SUV, BUT NOT AS YOU KNOW IT**



It's a level of performance you just don't expect from an SUV. Mazda CX-5 gives you sporty responses and nimble handling, yet breakthrough SKYACTIV TECHNOLOGY also achieves amazing fuel economy. It adds to driving enjoyment with cleverly integrated online connectivity, and heightens confidence with the advanced safety of i-ACTIVSENSE. All of this and you also have stylish and dynamic design, resulting in a uniquely athletic SUV.

Akera in Soul Red Metallic.



GET READY TO SEE THE SUV DIFFERENTLY



Mazda CX-5 is an SUV created from a different perspective. Sculpted, commanding and dynamic, it's been shaped without compromise. It's the result of our design direction, 'KODO – Soul of Motion'. The powerful, athletic cues of KODO capture the muscular beauty of an animal springing into motion. The energetic leap of a cheetah is reflected in Mazda CX-5. With elegant lines, graceful details and a well-planted footprint, it stands proudly apart from other SUVs.

魂動

KODO : SOUL of MOTION

Akera in Soul Red Metallic.



## YOU'RE IN A GREAT SPACE



Carefully considered design orientates everything around you. Impressive attention to detail means it always feels special. Mazda CX-5 positions controls and information to help you stay focused on the road ahead. The elegant, uncluttered atmosphere makes the sense of space and comfort even stronger. Distinct trim colours and textures feature in each model and are complemented by metallic highlights. Grand Touring and Akera add further stylish accents and superb premium leather.<sup>1</sup>

Want to stay linked to your world while you're on the road? MZD Connect gives you social media feeds and a range of other online content on a central screen. It also covers satellite navigation, reversing camera and system settings.

Akera in pure white leather trim.<sup>1</sup>



**SINCE WHEN DID AN SUV DRIVE LIKE THIS?**



Drive Mazda CX-5 and you'll never go back to an ordinary SUV. SKYACTIV TECHNOLOGY results in reduced weight, which helps to unleash agility more in keeping with a sports car. Enjoy it in front-wheel drive, or gripping all-wheel drive. SKYACTIV-G petrol engines give you responsive, smooth power from 2.0 or 2.5 litres.

With SKYACTIV-D you've got punchy turbo diesel thrust from 2.2 litres. Whichever you choose, fuel economy is exceptional. In both automatic and manual transmissions gear shifts are seamless and swift. It all comes together with remarkable refinement, thanks to a luxurious ride and a body that moves efficiently through the air.

Akera in Soul Red Metallic.



# PERFORMANCE LIKE YOU'VE NEVER KNOWN. SKYACTIV TECHNOLOGY



## SKYACTIV-G 2.0 & 2.5L PETROL ENGINE

A fundamental rethink of the internal combustion engine releases more performance from less fuel. Precise multi-hole direct injection minimises fuel use. A unique piston design achieves more efficient combustion to boost power and lower emissions. A major reduction of internal friction liberates extra power, while a free-breathing 4-2-1 exhaust layout enhances efficiency. The 2.0 litre 4-cylinder engine delivers a sporty 114kW of power and 200Nm of torque, using only 6.4 litres of fuel every 100km.<sup>2</sup> The muscular 2.5 litre engine punches out 138kW and 250Nm, yet uses just 7.4 litres of fuel per 100km.<sup>2</sup>



## SKYACTIV-D 2.2L DIESEL ENGINE

A far lower compression ratio than conventional diesels allows for lighter internal components. This reduces friction and inertia for higher-revving, more exciting power – right up to 5,500rpm. Multi-hole piezo injectors and variable valve lift optimise engine breathing and economy. The 2.2 litre 4-cylinder engine produces 129kW and a muscular 420Nm of torque, using just 5.7 litres of fuel per 100km.<sup>2</sup> With a two-stage turbocharger maximising efficiency, the SKYACTIV-D engine meets strict Euro stage IV emissions standards without requiring expensive after treatment of exhaust gases.

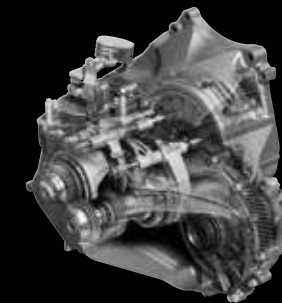

## SKYACTIV-MT MANUAL TRANSMISSION

The 6-speed manual transmission delivers precise, sports-car style shifting through simplified design and a finely-honed mechanism. More compact and also much lighter than comparable transmissions, it significantly cuts internal friction to improve fuel economy.

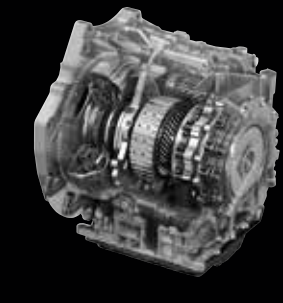

## SKYACTIV-DRIVE AUTOMATIC TRANSMISSION

We've combined the best attributes of conventional automatic, continuously variable and dual clutch transmissions. The transmission locks up to couple directly with the engine over a far wider range than other automatics. This delivers a significant improvement in fuel economy and a more direct, manual-like power delivery and driving feel. Shifts are quick, accurate and smooth across the six speeds.

At Mazda, we're passionate about driving enjoyment, but we're also committed to reducing the environmental impact of our cars. We're meeting this challenge with a groundbreaking approach – that we call SKYACTIV TECHNOLOGY. Put simply, we've re-engineered every aspect of Mazda CX-5 to unleash greater efficiency and more driving enjoyment than any SUV has ever offered. Fuel economy is enhanced by our clever i-stop system. It turns off the engine when you come to a stop, keeping it positioned for virtually instant restart when you are ready to move away.



## SKYACTIV-BODY

The application of high and ultra-high tensile steel cuts weight, yet bolsters rigidity. Front and rear suspension mounting points bond directly to the underbody to further add strength. Even the doors use special pressing methods to reduce weight without compromising strength. Despite being light, Mazda CX-5 disperses crash energy in multiple directions to achieve world-class collision performance.

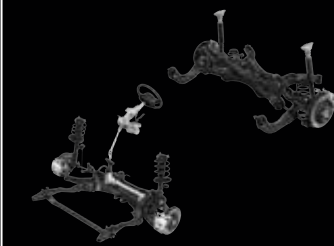

## SKYACTIV-CHASSIS

Every component has been re-designed to create an unrivalled sense of 'oneness' between car and driver. For nimble handling with great ride comfort, the chassis uses firmer bushings and completely revised geometry. A highly rigid front suspension cross member combines with higher-ratio electric power assist steering to quicken handling. Both front and rear cross members improve stiffness and lower weight, thanks to an innovative welding method. It all gives Mazda CX-5 agility you'd never expect in an SUV.

# WHEREVER YOU GO, YOU'RE CONNECTED

When you're on the move in Mazda CX-5, your online world can move right with you. Simply link up your compatible<sup>3</sup> smart phone and MZD Connect links you to a load of content including Facebook and Twitter feeds, radio, podcasts and more. It will even read texts and e-mails for you. It's all brought together on a central touch screen placed to help your eyes stay on the road. Further reducing distraction is the rotary commander, naturally falling to hand to give you control over functions. Not only that but menu choice, audio and navigation respond to voice command.



### THE WAY IS CLEAR

Satellite navigation easily read on a 7-inch colour touch-screen. Features spoken street names and advanced lane guidance. Standard from Maxx Sport up.



### FINGERTIP CONTROL

Multi-function commander allows effortless selection of menus and functions with minimum distraction.



**PANDORA**  
INTERNET RADIO

**aha**  
by HARMAN

**STITCHER**  
RADIO ON DEMAND

### BRING YOUR ONLINE WORLD

You can access a huge range of online content by linking your smart phone<sup>3</sup> seamlessly through MZD Connect.

Akera in black leather trim.<sup>1</sup>



The latest in clever tech lets you make more enjoyable, safer progress. Grand Touring and Akera models increase your visibility to other drivers with daytime running lamps. At night they give you the superb illumination of LED headlamps. Grand Touring adds an Adaptive Front-lighting System (AFS), which angles the headlamps up to 15 degrees in the direction you're steering so more of the corner is seen. Akera models switch on Adaptive LED Headlamps (ALH) technology. Through precision control of LEDs this adapts the lighting pattern for broader low speed visibility, a high beam that limits glare for other drivers, and a raised beam height at highway speeds for extended vision. In every model you've got hands-free phone hook up and music streaming via Bluetooth®, not to mention integrated USB ports.



**EXTRA EYES**

Side view monitor helps you avoid kerbs or obstacles while parking, showing side mirror camera image on central screen. Guide lines indicate vehicle extremities in relation to potential obstacles. Akera only.

**PERFORMANCE SPACE**

Music reaches another level with premium Bose® digital audio delivering 231 watts of power through 9 speakers. Grand Touring and Akera.

**FORWARD LOOKING**

ALH automatically adjusts individual LEDs, allowing the lighting pattern to be shaped according to the situation. LED fog-lamps boost visibility in foggy or inclement weather conditions. Akera only.



## LET'S GET COMFORTABLE



Mazda CX-5's cabin accommodates five people and their gear in roomy comfort. With the rear seats raised, the cargo area can swallow four big golf bags. Access is via an easy-opening tailgate integrating a 'Karakuri' tonneau cover. It moves in unison with the tailgate to shield against sunlight and prying eyes.

By splitting 60/40 the rear seats help accommodate large or unusually shaped cargo. Maxx Sport and up feature a highly flexible 40/20/40 arrangement. The middle seat opens up a central tunnel, enabling long items to be carried along with rear passengers. These seats create a virtually flat floor when folded and can be remotely controlled by a luggage bay lever. Naturally, Mazda CX-5's supportive seating is complemented by thoughtfully integrated storage.

Akera in pure white leather trim!



# THERE'S EVERY REASON TO FEEL SAFE

Agile handling and interior design that enhances concentration on the road mean you're well placed to respond to trouble. You've also got the best in safety to reassure you.

Mazda CX-5 features an extremely rigid body giving you world-class collision protection. Dynamic Stability Control (DSC) and SRS airbags are standard.

The powerful disc brakes are equipped with ABS and Electronic Brake-force Distribution (EBD), which manages braking force according to vehicle load.

Emergency Brake Assist (EBA) boosts stopping power the instant it recognises emergency braking. Screen integrated parking sensors (front and rear) feature on Grand Touring and Akera. Audible alerts are supported by on-screen graphics showing the detected object and its proximity when sensors are active.

The responsive drive of CX-5 goes hand in hand with great confidence.



Akera in Soul Red Metallic.

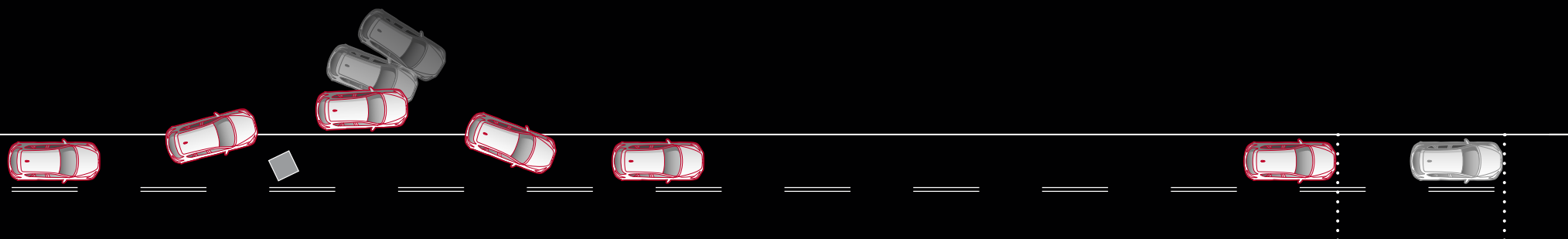

## PREPARED FOR THE UNEXPECTED

What if an unexpected hazard suddenly arises? DSC acts instantly, braking the inner rear wheel to offset understeer (or outer front wheel to combat oversteer). The Traction Control System (TCS) also reduces torque to the driven wheels to minimise skidding. The hazard can be steered around, as control is maintained.

## SUPERIOR STOPPING

Stopping distance with EBA, ABS and EBD. : Stopping distance with no assistance. :



## HILL LAUNCH ASSIST (HLA)

Take your foot from the brake on an incline and the brakes stay applied for about two seconds. So there's time to apply the accelerator and take-off smoothly.



# i-ACTIVSENSE. SAFETY SO ADVANCED, IT CAN SENSE POTENTIAL TROUBLE

With the availability of advanced i-ACTIVSENSE technology,<sup>4</sup> you can enjoy an even greater sense of confidence. These intelligent systems are designed to help you recognise potential hazards, avoid collisions and minimise the severity of accidents when they can't be avoided. Employing sophisticated radar, cameras, and driver warnings, i-ACTIVSENSE literally looks out for you.

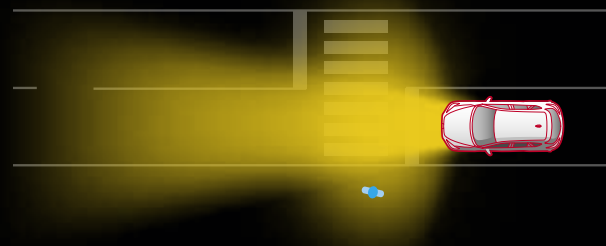

### ADAPTIVE LED HEADLAMPS (ALH)

Individual control of several LEDs allows precise adjustment of the lighting pattern. The system automatically broadens visibility at low speeds, shapes the high beam to help avoid dazzling oncoming drivers, and raises beam height at highway speeds to extend vision area. Akera only.

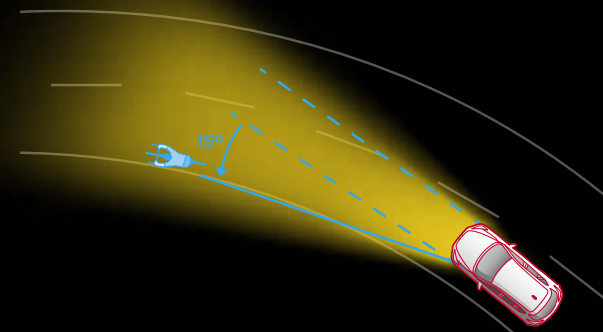
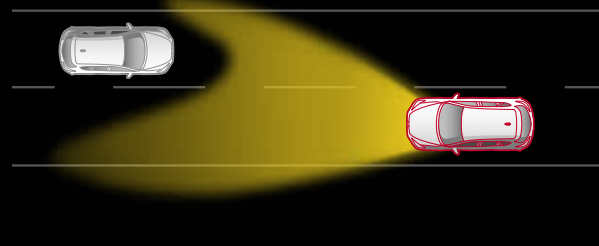

### ADAPTIVE FRONT-LIGHTING SYSTEM (AFS)

The powerful LED headlamps swivel up to 15 degrees in the direction you're steering, revealing more of the corner. Grand Touring only.

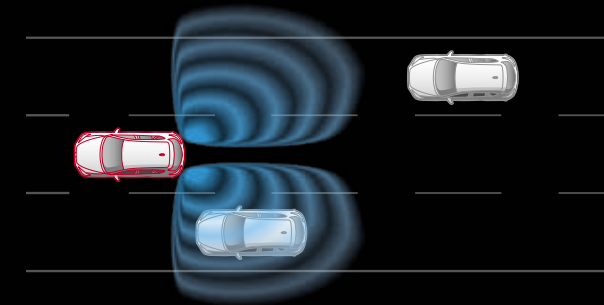

### BLIND SPOT MONITORING (BSM)

By scanning external mirrors' blind spots, radars detect any unseen vehicles to help you avoid making hazardous lane changes. LED icon on the relevant mirror is accompanied by warning beeper. Optional across range, standard on Akera.

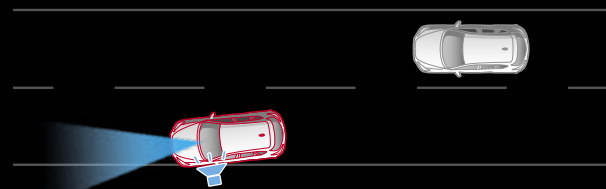

### LANE DEPARTURE WARNING (LDW) WITH LANE-KEEP ASSIST SYSTEM (LAS)

Using a windscreen-mounted camera to monitor road lane markings, LDW sounds an audible warning if you're about to stray from your lane. LAS will act if it determines the vehicle is going to leave its lane, by applying a degree of corrective steering. Driver Attention Alert (DAA) is also integrated. When speeds above 65km/h are sustained for longer periods, the system monitors driver inputs and provides a visual warning if it detects signs of fatigue. Also provides alert when 2 hours have elapsed. Akera only.

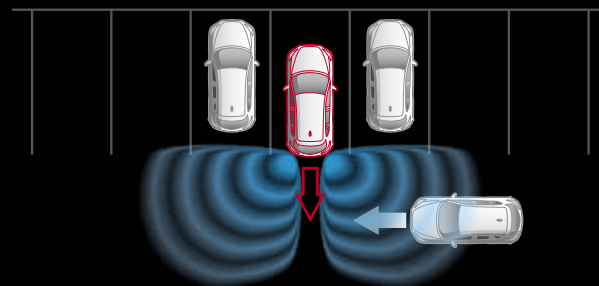

### REAR CROSS TRAFFIC ALERT (RCTA)

Assists you when you're reversing from a parking space, warning if a car is approaching from either side of your vehicle. The LED icon on both mirrors is accompanied by beeping alert. Optional across range, standard on Akera.

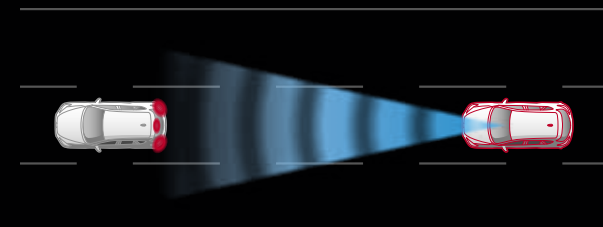

### FORWARD OBSTRUCTION WARNING (FOW) WITH SMART BRAKE SUPPORT (SBS)

Operating at 15-145km/h the system monitors the distance to the vehicle in front and its speed. FOW senses if a collision is likely and prompts you to take evasive action via audible and visual alerts. If SBS senses a high risk of impact it applies initial pressure to the brakes, enabling faster response should you brake. If you take evasive action SBS de-activates. If no evasive action is taken, the brakes are applied automatically. Akera only.

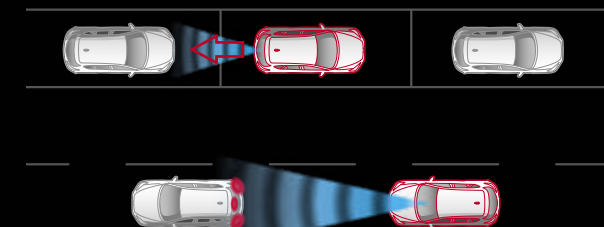

### SMART CITY BRAKE SUPPORT [FORWARD/REVERSE] (SCBS F/R)

Helps prevent, or lessen, low-speed impacts. At forward speeds of 4-30km/h, SCBS monitors the vehicle in front to assess the possibility of a collision. If the system detects a high risk of impact it issues visual and audible warnings, while priming the brakes for faster response should the driver brake. If the driver does not brake, the brakes are applied automatically. Also works in reverse at speeds of 2-8km/h. Optional on Grand Touring, standard on Akera. Forward only (SCBS F) optional on Maxx and Maxx Sport.



# MAZDA CX-5

MAXX



Maxx in Sonic Silver Metallic.



## Maxx features include:

- 17 inch steel wheels with 225/65 tyres
- Headlamps (Halogen)
- Power mirrors (body coloured with folding function)
- Rear spoiler
- Wipers (front) 2-speed with variable intermittent function
- Front seats with: height adjustment (driver) and seat back pockets
- Rear seats with: 60/40 split fold backrest
- Seat trim: Black cloth
- Cargo area tonneau cover with 'Karakuri' up and down function
- Cruise control
- Electric parking brake
- Trip computer<sup>5</sup>
- 7-inch full colour touch screen display (MZD Connect)
- Audio system with: AM/FM tuner, single disc CD player (MP3 compatible) and 4 speakers
- Bluetooth® hands-free phone and audio capability<sup>3</sup>
- Internet radio integration (Pandora®, Stitcher™ and Aha™)
- Multi-function commander control
- Steering wheel-mounted audio controls
- USB-audio input ports (iPod compatible)
- Advanced keyless push-button engine start
- Airbags SRS: front (driver and passenger), side (front) and curtain (front and rear)
- Dynamic Stability Control (DSC)
- Emergency Stop Signal (ESS)
- Hill Launch Assist (HLA)
- ISOFIX child restraint anchor points and top tethers
- Reverse camera
- Tyre Pressure Monitoring System (TPMS)

## Safety Pack option<sup>4</sup>:

- Blind Spot Monitoring (BSM)
- Rear Cross Traffic Alert (RCTA)
- Rear-view mirror with auto dimming function
- Smart City Brake Support [Forward] (SCBS F)

## Powertrain:

- 2.0 litre in-line 4 cylinder 16 valve DOHC S-VT petrol (SKYACTIV-G) engine with i-stop
- Max power: 114kW @ 6,000rpm
- Max torque: 200Nm @ 4,000rpm
- Fuel consumption (combined): 6.4 l/100km<sup>2</sup>

## OR

- 2.5 litre in-line 4 cylinder 16 valve DOHC S-VT petrol (SKYACTIV-G) engine with i-stop
- Max power: 138kW @ 5,700rpm
- Max torque: 250Nm @ 4,000rpm
- Fuel consumption (combined): 7.4 l/100km<sup>2</sup>



## ADVANCED INFOTAINMENT

Just hook up your smart phone<sup>3</sup> to access a wide range of online content through MZD Connect.



## ONE BUTTON PARK BRAKE

Electronic parking brake engages and disengages via a simple button. Warning light shows when it's applied.



## PLUGGED IN

Standard USB inputs let you access music via players or storage devices, and charge compatible devices.





# MAZDA CX-5

MAXX SPORT



Maxx Sport in Meteor Grey Mica.



## Maxx Sport features additional to Maxx include:

- 17 inch alloy wheels
- Front fog-lamps (Halogen)
- Headlamps auto on/off function
- Wipers (front) 2-speed with rain-sensing function
- Rear seats with: 40/20/40 split fold backrest (flat fold) and centre fold down armrest
- Air-conditioning (dual-zone climate control)
- Leather wrapped: gear shift knob and steering wheel
- Vanity mirrors (front) with illumination
- Audio system with: 6 speakers
- Satellite navigation

## Safety Pack option<sup>4</sup>:

- Blind Spot Monitoring (BSM)
- Rear Cross Traffic Alert (RCTA)
- Rear-view mirror with auto dimming function
- Smart City Brake Support [Forward] (SCBS F)

## Powertrain:

- 2.0 litre in-line 4 cylinder 16 valve DOHC S-VT petrol (SKYACTIV-G) engine with i-stop
- Max power: 114kW @ 6,000rpm
- Max torque: 200Nm @ 4,000rpm
- Fuel consumption (combined): 6.4 l/100km<sup>2</sup>

OR

- 2.5 litre in-line 4 cylinder 16 valve DOHC S-VT petrol (SKYACTIV-G) engine with i-stop
- Max power: 138kW @ 5,700rpm
- Max torque: 250Nm @ 4,000rpm
- Fuel consumption (combined): 7.4 l/100km<sup>2</sup>

OR

- 2.2 litre in-line 4 cylinder 16 valve DOHC intercooled turbo diesel (SKYACTIV-D) engine with i-stop
- Max power: 129kW @ 4,500rpm
- Max torque: 420Nm @ 2,000rpm
- Fuel consumption (combined): 5.7 l/100km<sup>2</sup>



## SPORTING STANCE

17-inch alloy wheels give Mazda CX-5 an even more sporting look, and enhance its outstanding handling.



## LEADS THE WAY

Satellite navigation clearly displayed on a 7-inch colour touch-screen. Features spoken street names and advanced lane guidance.



## PERFECT CLIMATE

With dual-zone climate control, both driver and passenger can enjoy just the right temperature.

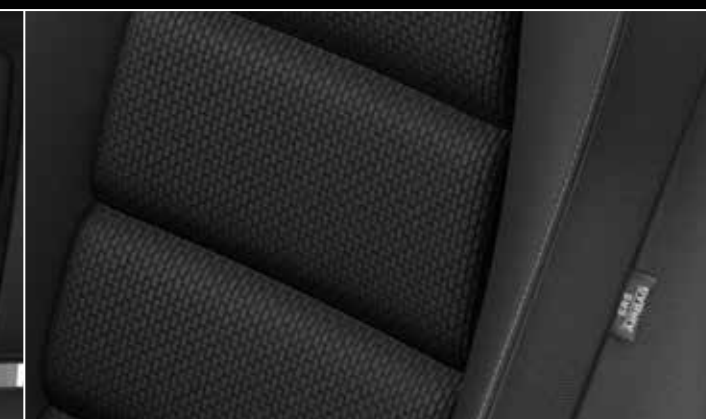

## COMFORTABLY APPOINTED

Inviting premium cloth features superbly crafted patterns and highlight stitching.



# MAZDA CX-5

GRAND TOURING



Grand Touring in Crystal White Pearl Mica.



**Grand Touring features additional to Maxx Sport include:**

- 19 inch alloy wheels with 225/55 tyres
- Daytime running lamps (LED)
- Front fog-lamps (LED)
- Headlamps (LED)
- Power sliding and tilt glass sunroof
- Tail-lamps (LED)
- Front seats with: 2-position memory function (driver), 6-way power adjustment (passenger), 8-way power adjustment (driver), heating function and lumbar support adjustment (driver)
- Seat trim: Black or pure white leather<sup>1</sup>
- Rear-view mirror with auto dimming function
- Premium Bose® 231 watt amplifier and 9 speakers
- Adaptive Front-lighting System (AFS)
- Advanced keyless entry
- Parking sensors (front and rear)

**Safety Pack option<sup>4</sup>:**

- Blind Spot Monitoring (BSM)
- Rear Cross Traffic Alert (RCTA)
- Smart City Brake Support [Forward/Reverse] (SCBS F/R)

**Powertrain:**

- 2.5 litre in-line 4 cylinder 16 valve DOHC S-VT petrol (SKYACTIV-G) engine with i-stop
- Max power: 138kW @ 5,700rpm
- Max torque: 250Nm @ 4,000rpm
- Fuel consumption (combined): 7.4 l/100km<sup>2</sup>

**OR**

- 2.2 litre in-line 4 cylinder 16 valve DOHC intercooled turbo diesel (SKYACTIV-D) engine with i-stop
- Max power: 129kW @ 4,500rpm
- Max torque: 420Nm @ 2,000rpm
- Fuel consumption (combined): 5.7 l/100km<sup>2</sup>



**BIG IMPRESSION**

Stunning 19-inch alloy wheels add to the athletic, elegant presence of CX-5.



**LET THE SUN SHINE**

Power-operated sliding glass sunroof integrates tilt function to suit your preference.



**HIGH NOTE**

Music is elevated by the power of a 231 watt Bose® digital amplifier driving 9 speakers.

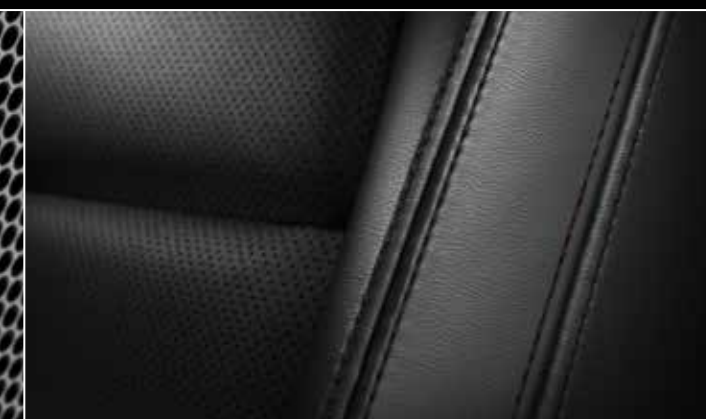

**INDULGENT INSIDE**

The luxury of superb black leather<sup>1</sup> seats is heightened by contrasting stitching. Pure white leather<sup>1</sup> seats also available.



# MAZDA CX-5

AKERA



Akera in Soul Red Metallic.



**Akera features additional to Grand Touring include:**

- Radar cruise control
- Adaptive LED Headlamps (ALH)
- Blind Spot Monitoring (BSM)
- Driver Attention Alert (DAA)
- Forward Obstruction Warning (FOW)
- Lane Departure Warning (LDW)
- Lane-keep Assist System (LAS)
- Rear Cross Traffic Alert (RCTA)
- Side monitor
- Smart Brake Support (SBS)
- Smart City Brake Support [Forward/Reverse] (SCBS F/R)



**BRIGHT THINKING**

Adaptive LED Headlamps (ALH) cleverly adjust lighting pattern, shape and height to maximise visibility and safety for other road users.



**SAFE DISTANCE**

Radar cruise control automatically adjusts speed to maintain safe distance from the car ahead.

**Powertrain:**

- 2.5 litre in-line 4 cylinder 16 valve DOHC S-VT petrol (SKYACTIV-G) engine with i-stop
- Max power: 138kW @ 5,700rpm
- Max torque: 250Nm @ 4,000rpm
- Fuel consumption (combined): 7.4 l/100km<sup>2</sup>

**OR**

- 2.2 litre in-line 4 cylinder 16 valve DOHC intercooled turbo diesel (SKYACTIV-D) engine with i-stop
- Max power: 129kW @ 4,500rpm
- Max torque: 420Nm @ 2,000rpm
- Fuel consumption (combined): 5.7 l/100km<sup>2</sup>

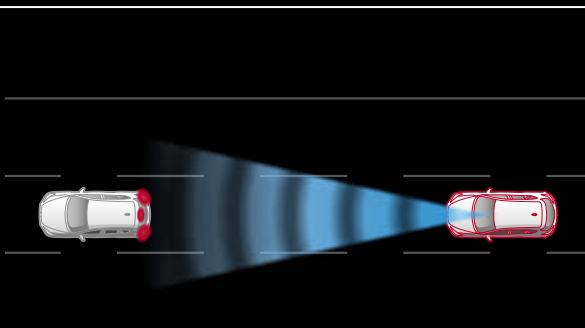

**LOOKING OUT FOR YOU**

i-ACTIVSENSE systems<sup>2</sup> use radar, cameras and sensors to help recognise potential hazards, avoid collisions and mitigate unavoidable accidents.



**PURE LUXURY**

Akera gives you luxurious leather<sup>1</sup> trim in pure white with contrast stitching. Black leather<sup>1</sup> also available.



# SPECIFICATIONS

Powertrain	2.0L I4 Petrol FWD	2.5L I4 Petrol AWD	2.2L I4 Diesel AWD	
Bore and stroke (mm)	83.5 x 91.2	89.0 x 100.0	86.0 x 94.3	
Compression ratio	13.0 : 1	13.0 : 1	14.0 : 1	
Emissions standard	Euro stage IV	Euro stage IV	Euro stage IV	
Engine capacity (cc)	1,998	2,488	2,191	
Engine type	2.0 litre in-line 4 cylinder 16 valve DOHC S-VT petrol (SKYACTIV-G) engine with i-stop	2.5 litre in-line 4 cylinder 16 valve DOHC S-VT petrol (SKYACTIV-G) engine with i-stop	2.2 litre in-line 4 cylinder 16 valve DOHC intercooled turbo diesel (SKYACTIV-D) engine with i-stop	
Fuel consumption (l/100km) <sup>2</sup> :	Manual (combined)	–	–	
	Auto (combined)	6.4	7.4	
Fuel system	Electronic direct injection	Electronic direct injection	Common rail, electronic direct injection	
Fuel tank capacity (litres)	56	58	58	
Gear ratio - Manual/Auto:	1st	3.700 / 3.552	– / 3.552	– / 3.487
	2nd	1.947 / 2.022	– / 2.022	– / 1.992
	3rd	1.300 / 1.452	– / 1.452	– / 1.449
	4th	1.029 / 1.000	– / 1.000	– / 1.000
	5th	0.837 / 0.708	– / 0.708	– / 0.707
	6th	0.680 / 0.599	– / 0.599	– / 0.600
	Reverse	3.724 / 3.893	– / 3.893	– / 3.990
	Final drive	4.705 / 4.624	– / 4.325	– / 4.090
Maximum power (kW @ rpm)	114 @ 6,000	138 @ 5,700	129 @ 4,500	
Maximum torque (Nm @ rpm)	200 @ 4,000	250 @ 4,000	420 @ 2,000	
Recommended fuel	Unleaded (91RON or higher) or E10	Unleaded (91RON or higher) or E10	Diesel	
Throttle control	Electronic (drive-by-wire)	Electronic (drive-by-wire)	Electronic (drive-by-wire)	
Transmission:	Manual	6-speed (SKYACTIV-MT)	–	–
	Auto	6-speed (SKYACTIV-Drive)	6-speed (SKYACTIV-Drive)	6-speed (SKYACTIV-Drive)

Model Availability		Maxx	Maxx Sport	Grand Touring	Akera
5-seat SUV:	2.0L I4 Petrol FWD / 6-speed manual	●	–	–	–
	2.0L I4 Petrol FWD / 6-speed automatic	●	●	–	–
	2.5L I4 Petrol AWD / 6-speed automatic	●	●	●	●
	2.2L I4 Diesel AWD / 6-speed automatic	–	●	●	●

Options		Maxx	Maxx Sport	Grand Touring	Akera
Safety Pack <sup>4</sup> :	Blind Spot Monitoring (BSM)	○	○	○	●
	Rear Cross Traffic Alert (RCTA)	○	○	○	●
	Rear-view mirror with auto dimming function	○	○	●	●
	Smart City Brake Support [Forward] (SCBS F)	○	○	–	–
	Smart City Brake Support [Forward/Reverse] (SCBS F/R)	–	–	○	●

Chassis		Maxx	Maxx Sport	Grand Touring	Akera
Brake diameter (mm):	Front	297	297	297	297
	Rear	303	303	303	303
Brake type:	Front	----- Ventilated disc -----			
	Rear	----- Solid disc -----			
Steering type		----- Electric power assist steering -----			
Suspension:	Front	----- MacPherson strut -----			
	Rear	----- Multi-link -----			
Turning circle kerb to kerb (m)		11.2	11.2	11.2	11.2
Tyre size		225/65 R17	225/65 R17	225/55 R19	225/55 R19
Tyre index		102V	102V	99V	99V
Wheel size		17 x 7.0 J	17 x 7.0 J	19 x 7.0 J	19 x 7.0 J
Wheel type		Steel	Alloy	Alloy	Alloy
Tyre size (spare)		----- 185/80 R17 -----			
Wheel size (spare)		----- 17 x 5.5 T -----			
Wheel type (spare)		----- Temporary (Steel) -----			

Weights and Capacities		Maxx	Maxx Sport	Grand Touring	Akera
5-seat SUV					
Cargo room volume VDA <sup>6</sup> (litres)		403	403	403	403
Cargo room volume VDA <sup>7</sup> (litres)		1,560	1,560	1,560	1,560
Kerb weight (kg):	2.0L I4 Petrol FWD / 6-speed manual	1,454 - 1,455	–	–	–
	2.0L I4 Petrol FWD / 6-speed automatic	1,486 - 1,487	1,490 - 1,491	–	–
	2.5L I4 Petrol AWD / 6-speed automatic	1,567 - 1,568	1,571 - 1,572	1,626 - 1,627	1,628
	2.2L I4 Diesel AWD / 6-speed automatic	–	1,644 - 1,645	1,699 - 1,700	1,701
Towing capacity <sup>8</sup> (kg):	Braked	1,800	1,800	1,800	1,800
	Unbraked	750	750	750	750
Tow ball download maximum (kg)		150	150	150	150

● = Standard, ○ = Option, – = Not available.



# SPECIFICATIONS

## Dimensions

5-seat SUV		Maxx	Maxx Sport	Grand Touring	Akera
Ground clearance laden (mm)		150	150	150	150
Overall length (mm)		4,540	4,540	4,540	4,540
Overall width (mm)		1,840	1,840	1,840	1,840
Overall height (mm)		1,710	1,710	1,710	1,710
Track (mm):	Front	1,585	1,585	1,585	1,585
	Rear	1,590	1,590	1,590	1,590
Wheelbase (mm)		2,700	2,700	2,700	2,700

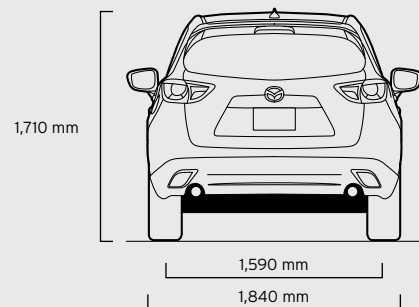
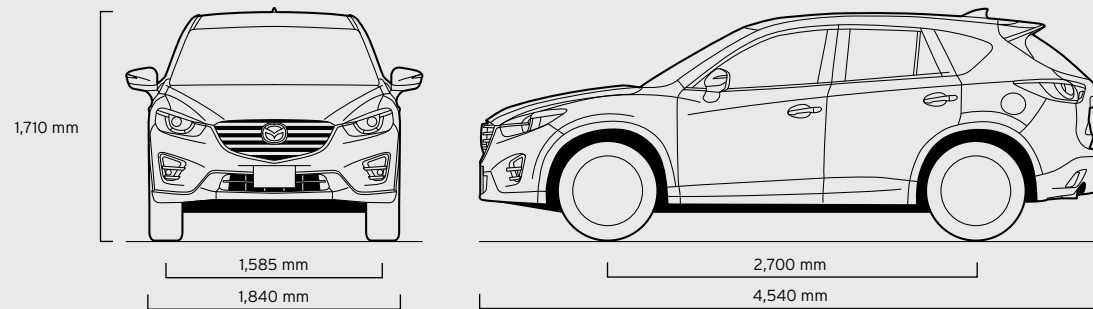

## Exterior

	Maxx	Maxx Sport	Grand Touring	Akera
Daytime running lamps (LED)	-	-	●	●
Door handles (body coloured)	●	●	●	●
Exhaust extensions (chrome)	●	●	●	●
Front and rear bumpers (body coloured)	●	●	●	●
Front fog-lamps (Halogen)	-	●	-	-
Front fog-lamps (LED)	-	-	●	●
Green-tinted windscreen, side and rear windows	●	●	●	●
Headlamps (Halogen)	●	●	-	-
Headlamps (LED)	-	-	●	●
Headlamps auto on/off function	-	●	●	●
Power mirrors (body coloured with folding function)	●	●	●	●
Power sliding and tilt glass sunroof	-	-	●	●
Power windows	●	●	●	●
Rear spoiler	●	●	●	●
Roof rack mounting points	●	●	●	●
Tail-lamps (LED)	-	-	●	●
Window demister (rear)	●	●	●	●
Wipers (front) 2-speed with rain-sensing function	-	●	●	●
Wipers (front) 2-speed with variable intermittent function	●	-	-	-
Wiper (rear) with intermittent function	●	●	●	●

## Seats

	Maxx	Maxx Sport	Grand Touring	Akera	
Front seats with:	2-position memory function (driver)	-	-	●	●
	6-way power adjustment (passenger)	-	-	●	●
	8-way power adjustment (driver)	-	-	●	●
	Adjustable head restraints	●	●	●	●
	Heating function	-	-	●	●
	Height adjustment (driver)	●	●	●	●
	Lumbar support adjustment (driver)	-	-	●	●
	Rake and slide adjustment	●	●	●	●
	Seat back pockets	●	●	●	●
Rear seats with:	40/20/40 split fold backrest (flat fold)	-	●	●	
	60/40 split fold backrest	●	-	-	
	Adjustable head restraints	●	●	●	●
	Centre fold down armrest	-	●	●	●
Seat trim:	Black cloth	●	●	-	-
	Black leather <sup>1</sup>	-	-	●	●
	Pure white leather <sup>1</sup>	-	-	○	○

● = Standard, ○ = Option, - = Not available.



# SPECIFICATIONS

Interior	Maxx	Maxx Sport	Grand Touring	Akera
Air-conditioning	●	–	–	–
Air-conditioning (dual-zone climate control)	–	●	●	●
Ambient temperature display	●	●	●	●
Cargo area 12 volt power outlet	●	●	●	●
Cargo area tonneau cover with 'Karakuri' up and down function	●	●	●	●
Centre armrest console	●	●	●	●
Critical function warning lights/chimes	●	●	●	●
Cruise control	●	●	●	–
Cupholders	●	●	●	●
Door bottle holders (front and rear)	●	●	●	●
Electric parking brake	●	●	●	●
Glove box	●	●	●	●
Instrument panel light dimmer	●	●	●	●
Interior illumination:				
Cargo room lamp	●	●	●	●
Entry system with delayed fade	●	●	●	●
Map reading spot lamps	●	●	●	●
Power window switch (driver)	●	●	●	●
Interior release for fuel filler door	●	●	●	●
Leather-wrapped:				
Gear shift knob	–	●	●	●
Steering wheel	–	●	●	●
One touch (up and down) power window (driver)	●	●	●	●
Overhead sunglass storage box	●	●	●	●
Radar cruise control	–	–	–	●
Rear-view mirror with auto dimming function	○	○	●	●
Tachometer and electronic odometer/tripmeter	●	●	●	●
Tilt and telescopic adjustable steering wheel	●	●	●	●
Trip computer <sup>5</sup>	●	●	●	●
Vanity mirrors (front)	●	–	–	–
Vanity mirrors (front) with illumination	–	●	●	●

Infotainment	Maxx	Maxx Sport	Grand Touring	Akera
7-inch full colour touch screen display (MZD Connect)	●	●	●	●
AM/FM tuner	●	●	●	●
Auxiliary audio input jack (3.5mm mini-stereo)	●	●	●	●
Bluetooth® hands-free phone and audio capability <sup>3</sup>	●	●	●	●
CD player, single disc (MP3 compatible)	●	●	●	●
Internet radio integration (Pandora®, Stitcher™ and Aha™)	●	●	●	●
Multi-function commander control	●	●	●	●
Premium Bose® 231 watt amplifier and speakers	–	–	●	●
Radio Data System (RDS) program information	●	●	●	●
Satellite navigation	–	●	●	●
Speakers (4)	●	–	–	–
Speakers (6)	–	●	–	–
Speakers (9)	–	–	●	●
Steering wheel-mounted audio controls	●	●	●	●
USB-audio input ports (iPod compatible)	●	●	●	●

Safety and Security	Maxx	Maxx Sport	Grand Touring	Akera
Adaptive Front-lighting System (AFS)	–	–	●	–
Adaptive LED Headlamps (ALH)	–	–	–	●
Advanced keyless entry	–	–	●	●
Advanced keyless push-button engine start	●	●	●	●
Airbags SRS:				
Front (driver and passenger)	●	●	●	●
Side (front)	●	●	●	●
Curtain (front and rear)	●	●	●	●
Anti-lock Braking System (ABS)	●	●	●	●
Blind Spot Monitoring (BSM)	○	○	○	●
Childproof rear door locks	●	●	●	●
Driver Attention Alert (DAA)	–	–	–	●
Dynamic Stability Control (DSC)	●	●	●	●
Electronic Brake-force Distribution (EBD)	●	●	●	●
Emergency Brake Assist (EBA)	●	●	●	●
Emergency Stop Signal (ESS)	●	●	●	●
Engine immobiliser	●	●	●	●
Forward Obstruction Warning (FOW)	–	–	–	●
High mount stop lamp	●	●	●	●
Hill Launch Assist (HLA)	●	●	●	●
Intrusion-minimising brake pedal	●	●	●	●
ISOFIX child restraint anchor points and top tethers	●	●	●	●
Lane Departure Warning (LDW)	–	–	–	●
Lane-keep Assist System (LAS)	–	–	–	●
Left-hand-side convex (wide angle) exterior mirror	●	●	●	●
Parking sensors (front and rear)	–	–	●	●
Rear Cross Traffic Alert (RCTA)	○	○	○	●
Remote central locking (2 transmitters)	●	●	●	●
Reverse camera	●	●	●	●
Seat-belt warning (front and rear)	●	●	●	●
Seat-belts 3-point lap-sash (all seats)	●	●	●	●
Seat-belts (front) with pretensioners, load-limiters and height adjustable shoulder anchorages	●	●	●	●
Side impact door beams	●	●	●	●
Side monitor	–	–	–	●
Smart Brake Support (SBS)	–	–	–	●
Smart City Brake Support [Forward] (SCBS F)	○	○	–	–
Smart City Brake Support [Forward/Reverse] (SCBS F/R)	–	–	○	●
Traction Control System (TCS)	●	●	●	●
'Triple H' safety construction with front and rear crumple zones	●	●	●	●
Tyre Pressure Monitoring System (TPMS)	●	●	●	●
Whiplash-minimising front seats	●	●	●	●

● = Standard, ○ = Option, – = Not available.



# ENJOY MAZDA CX-5 WITH CONFIDENCE



## Rest assured – your warranty

The quality built into Mazda CX-5 is backed up by a 3-year, unlimited kilometre factory warranty and 6-year panel protection warranty.

## Maintain that Zoom-Zoom

Your Mazda CX-5 deserves the best in care. Servicing with Mazda Service Select gives your car the advantage of factory trained Service Technicians and advanced computer diagnostic systems. As well as maintaining your Mazda in A1 condition, you'll also be protecting your vehicle's outstanding resale value.



## Help is at hand – Mazda Roadside Assistance

Flat batteries, running out of fuel, flat tyres – everyone faces hiccups from time to time. When the unexpected happens, Mazda Roadside Assistance is there to keep you moving. You'll be covered 24 hours a day, 365 days a year, all round Australia. Better still, your Mazda will only be worked on by Mazda-approved technicians. Choose a Standard policy offering everything needed to get going again, or Premium with extras like accommodation, a rental car and vehicle recovery. Either can be purchased across the entire Mazda range. (Terms and conditions apply)

# MAZDA CX-5 COLOUR AND TRIM

## BODY COLOURS



Crystal White Pearl Mica

Sonic Silver Metallic

Blue Reflex Mica ■

Soul Red Metallic\* ■



Meteor Grey Mica ■

Titanium Flash Mica

Deep Crystal Blue Mica ■

Jet Black Mica

## INTERIOR TRIM

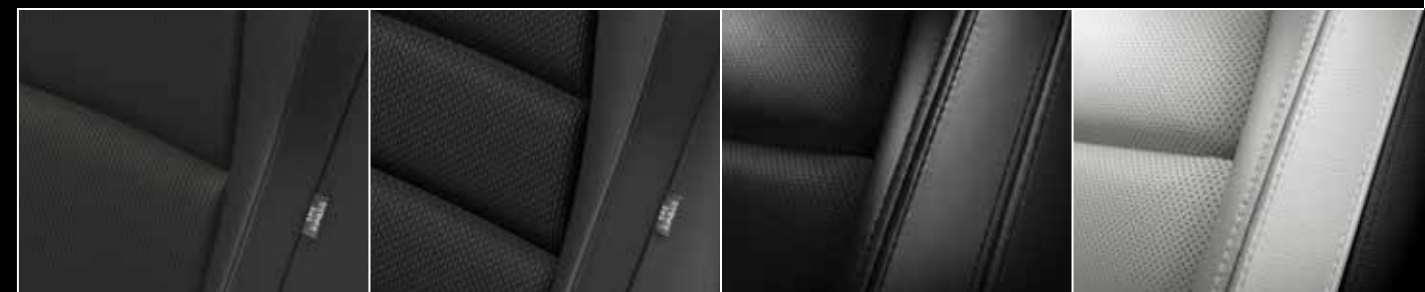

Black cloth (Maxx)

Black cloth (Maxx Sport)

Black leather<sup>1</sup> (Grand Touring and Akera)

Pure white leather<sup>1</sup> ■ (Grand Touring and Akera)

(1) Leather interior includes some Maztex material on selected high impact surfaces. Pure white leather interior only available with selected exterior colours. (2) Combined fuel consumption figures are based on ADR 81/02 test results. They are useful in comparing the fuel consumption of different vehicles. They may not be the fuel consumption achieved in practice. This will depend on traffic and road conditions and how the vehicle is driven. (3) Please check the compatibility of your Bluetooth® device (particularly your mobile phone) with the specific Mazda vehicle you intend to purchase as not all devices operate correctly. Visit [www.mazda.com.au/Bluetooth](http://www.mazda.com.au/Bluetooth) or consult your Mazda Dealer for further information. (4) i-ACTIVSENSE safety technologies are driver assist technologies only and should not be used in place of skilled and safe driving practices. It is the driver's sole responsibility to constantly monitor vehicle surroundings and conditions at all times. (5) Trip computer displays current and average fuel consumption, distance to empty and average vehicle speed. (6) Cargo room - measured with rear seats up and up to tonneau cover. (7) Cargo room - measured with rear seats folded down and up to roof. (8) Subject to State or Territory regulations.

All care is taken to ensure the accuracy of this brochure at the time of publication. Specifications, features and model availability may vary from State to State and may change without notice. Please refer to [mazda.com.au](http://mazda.com.au) or consult your Mazda Dealer prior to placing an order to ascertain current information on model availability, specifications, options, features and prices. Mazda Australia Pty Ltd will not be liable for any loss arising from the information in this brochure, whether in negligence or otherwise. Mazda Australia Pty Ltd ABN 78 004 690 804, 385 Ferntree Gully Road, Mt Waverley, Victoria 3149. iPod is a trademark of Apple Inc., registered in the U.S. and other countries. Due to the nature of the printing process, colours may vary from those shown in this brochure. Ask your Dealer to show you a product sample.

\*At extra cost

■ Pure white leather only available with Blue Reflex Mica, Soul Red Metallic, Meteor Grey Mica and Deep Crystal Blue Mica exterior colours.



mazda

zoom-zoom  
zoom-zoom  
zoom-zoom



Like us on the official Mazda Australia fan page for the latest pictures, videos, events, news and competitions. Ask questions, give feedback or upload your own photos. Join the conversation at [facebook.com/mazdaaus](https://facebook.com/mazdaaus)



Join the conversation on Twitter. Keep up with breaking Mazda news, videos and pictures from around the web. Tweet your questions, give feedback or post your own photos. [twitter.com/mazdaaus](https://twitter.com/mazdaaus)



Visit Mazda Australia's YouTube channel. You'll find video content with exclusive behind-the-scenes footage. [youtube.com/zoomzoom](https://youtube.com/zoomzoom)

Published January 2015. MAZ11470 126.024

For further information visit [mazda.com.au](https://mazda.com.au) or Freecall 1800 034 411



*MAZDA CX-5  
ACCESSORIES*



**mazda**



*zoom-zoom  
zoom-zoom  
zoom-zoom*

*IMAGINATION DRIVES US*



## MAKE YOUR MAZDA EVEN MORE REWARDING

Mazda CX-5 gives you SUV practicality, yet is amazingly agile and economical too. With Mazda Genuine Accessories, Mazda CX-5 ownership is even more enjoyable. They let you personalise your car, and protect your investment. What's more, they deliver superb design, quality and safety, all backed by a Mazda Genuine Warranty. Mazda Genuine Accessories give you even more Zoom-Zoom.



### CARGO TRAY

A tailor-fitted non-slip tray that guards against scratches, dirt and water.



### CARGO ORGANISER BOX

Prevent items from sliding around in the cargo area. Features moveable internal dividers, detachable lids and securable base.



### CARGO BARRIER

Protect occupants from loose cargo during heavier braking applications, with this steel mesh barrier. 60kg capacity.\*



### BOOT LIP PROTECTOR

Protect your rear bumper and boot lip from scratches and scuffs during loading and unloading.



### BONNET PROTECTOR (SMOKE)

Protect your car's paint against unwanted damage from stones and other debris.



### COLLAPSIBLE SUN SCREEN

Keep your vehicle cool and protect the interior from the sun's harmful rays.

### FEATURED HERE

- Reverse parking sensors
- Tow bar<sup>2</sup>



### MOBILE PHONE HOLDER

Safe, stylish and compatible with many popular phones, this gives drivers easy phone visibility and access. Allows portrait or landscape use.



### REAR WINDOW SHADES

Protect passengers and cargo from the sun. The set covers both passenger windows.



### SEAT COVERS (FRONT)

Durable, waterproof neoprene protects against dirt and grime. Airbag compatible.



### SEAT COVERS (REAR)

A lightweight, waterproof cover that shields the rear seats from spills, dirt, pet scratches and everyday wear and tear.



### SCUFF PLATES

Stylish protection against entry scuffs and scratches.



### MUD GUARDS (REAR)

Stop mud and road grime collecting on the rear end of your car.



FEATURED HERE

- Bonnet protector (clear)
- Front parking sensors
- Headlight protectors
- Roof racks
- Slimline weathershields
- 17-inch 15-spoke alloy wheels



CX-5 Grand Touring in Soul Red.



**BIKE RACK (WHEEL OFF)**

Makes it easy to take your bike along for the ride.



**BIKE RACK (WHEEL ON)**

Bring your other wheels along without having to remove one.



**KAYAK HOLDER**

The convenient way to transport kayaks or canoes.



#### FLOOR MATS (CARPET)

Protect your carpet with these high-quality, tailor-made floor mats. Fastening system enhances safety.

#### FLOOR MATS (RUBBER)

Heavy-duty tailor-made rubber mats give your interior durable protection.



#### SATELLITE NAVIGATION

Sat Nav directs you to your destination with ease. Features appear on 7-inch display. (Maxx only)

#### SCREEN INTEGRATED PARKING SENSORS

Augment audible warnings with graphic display of the object detected by sensors, and its proximity. Graphic appears on 7-inch display.



#### AUDIO RETRACTABLE USB CABLE

Stream music and track data from your iPhone® or iPod® to vehicle's audio system and multi information display. Also charges your device.

#### MAZDA RETRACTABLE AUDIO CABLE

Allows portable audio devices to play via your vehicle's speakers, using the auxiliary jack.

#### ALSO AVAILABLE

- Alloy accelerator pedal
- Alloy brake pedal (AT)
- Alloy brake and clutch pedal set (MT)
- Alloy foot rest
- Mud guards (front)
- Tow ball (chrome)
- Tow ball cover (chrome)
- Welcome illumination
- Wheel lock set

SEE THE FULL RANGE OF MAZDA GENUINE ACCESSORIES AT [MAZDA.COM.AU](http://MAZDA.COM.AU)



**zoom-zoom**

1. Engineered to meet Australian Occupation Safety Standard AS/NZ 4043.1. 2. Features maximum 1,800kg braked towing capacity and 150kg tow ball download limit. Subject to State or Territory regulations. Chrome tow ball sold separately. All care is taken to ensure the accuracy of this brochure at the time of publication. Sports and other equipment shown are for illustration purposes only and do not come standard with the vehicle, or as Mazda Genuine Accessories. Specifications, features and availability may vary from State to State and may change without notice. Please refer to [mazda.com.au](http://mazda.com.au) or consult your Mazda Dealer prior to placing an order to ascertain current information on availability, specifications, features and prices. Mazda Australia Pty Ltd will not be liable for any loss arising from the information in this brochure, whether in negligence or otherwise. Mazda Australia Pty Ltd ABN 78 004 690 804. 385 Ferntree Gully Road, Mount Waverley, Victoria 3149. All Mazda Genuine Accessories fitted at the point of sale of a new Mazda passenger vehicle are covered under the Mazda 3-year/unlimited kilometre warranty. Mazda Genuine Accessories fitted after the sale of a new Mazda vehicle are covered by the Mazda 2-year or 40,000 kilometre warranty (whichever should occur first). iPod® and iPhone® are trademarks of Apple Inc., registered in the U.S. and other countries. Published December 2014. MAZ11301 126.025